

REVISION

MODEL 172R

PILOT'S OPERATING HANDBOOK
AND FAA APPROVED
AIRPLANE FLIGHT MANUAL

REVISION 9

19 JULY 2004

172RPHUSR09

INSERT THE FOLLOWING PAGES INTO
THE PILOT'S OPERATING HANDBOOK

[Faint, illegible text, likely bleed-through from the reverse side of the page]

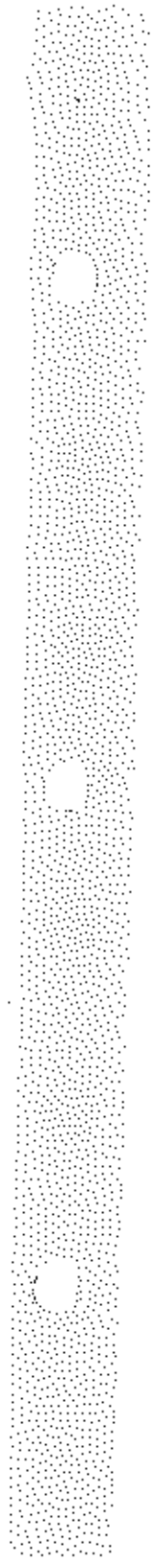

1

1

CESSNA
MODEL 172R

PUBLICATION PART NUMBER

Pilot's Operating Handbook
and
FAA Approved Airplane Flight Manual

Serial Numbers 17280001 and On

Original Issue - 2 December 1996

Revision 9 - 19 July 2004

PART NUMBER: 172RPHUS09

1. The first part of the document is a list of names and addresses of the members of the committee.

2. The second part of the document is a list of names and addresses of the members of the committee.

3. The third part of the document is a list of names and addresses of the members of the committee.

LOG OF EFFECTIVE PAGES

The following Log of Effective Pages provides the date of issue for original and revised pages, as well as a listing of all pages in the POH. Pages which are affected by the current revision will be preceded by an asterisk with the revision level.

| <u>Revision Level</u> | <u>Date of Issue</u> | <u>Revision Level</u> | <u>Date of Issue</u> |
|-----------------------|----------------------|-----------------------|----------------------|
| 0 (Original Issue) | Dec 2, 1996 | 5 | Dec 30, 2000 |
| 1 | Feb 28, 1997 | 6 | Mar 2, 2001 |
| 2 | Nov 3, 1997 | 7 | Mar 25, 2003 |
| 3 | Mar 12, 1999 | 8 | Aug 12, 2003 |
| 4 | Feb 28, 2000 | 9 | July 19, 2004 |

| <u>PAGE</u> | <u>DATE/REV</u> | <u>PAGE</u> | <u>DATE/REV</u> |
|----------------------|-----------------|-----------------|-----------------|
| Title | Dec 2/96 | | |
| Assignment Record .. | Dec 2/96 | 1-15 | Feb 28/97 |
| * iii | Revision 9 | 1-16 | Feb 28/00 |
| iii | Dec 2/96 | 1-17 | Revision 7 |
| iv | Feb 28/00 | 1-18 | Revision 4 |
| v | Revision 8 | 1-19 | Revision 7 |
| vi | Feb 28/00 | 1-20 | Revision 7 |
| vii | Feb 28/00 | 1-21 | Feb 28/00 |
| viii | Dec 2/96 | 1-22 | Feb 28/00 |
| * ix | Revision 9 | 1-23 | Feb 28/00 |
| * x | Revision 9 | 1-24 | Nov 3/97 |
| * xi | Revision 9 | 1-25 | Revision 7 |
| * xii | Revision 9 | 1-26 | Revision 7 |
| xiii/xiv | Revision 8 | 1-27/1-28 | Revision 7 |
| 1-1 | Revision 7 | 2-1/2-2 | Revision 8 |
| 1-2 | Revision 7 | 2-3 | Revision 4 |
| 1-3 | Revision 7 | 2-4 | Revision 7 |
| 1-4 | Revision 7 | 2-5 | Revision 7 |
| 1-5 | Revision 7 | 2-6 | Revision 7 |
| 1-6 | Revision 7 | 2-7 | Dec 2/96 |
| 1-7 | Revision 7 | 2-8 | Dec 2/96 |
| 1-8 | Original Issue | 2-9 | Original Issue |
| 1-9 | Revision 8 | 2-10 | Revision 7 |
| 1-10 | Revision 7 | 2-11 | Original Issue |
| 1-11 | Revision 7 | 2-12 | Revision 7 |
| 1-12 | Revision 7 | 2-13 | Original Issue |
| 1-13 | Revision 4 | 2-14 | Revision 7 |
| 1-14 | Revision 7 | 2-15/2-16 | Revision 8 |

LOG OF EFFECTIVE PAGES
(Continued)

| <u>PAGE</u> | <u>DATE/REV</u> | <u>PAGE</u> | <u>DATE/REV</u> |
|-------------|-----------------|-------------|-----------------|
| 3-1 | Revision 7 | 4-18 | Revision 4 |
| 3-2 | Revision 7 | 4-19 | Revision 7 |
| 3-3 | Revision 4 | 4-20 | Revision 7 |
| 3-4 | Revision 7 | 4-21 | Revision 7 |
| 3-5 | Revision 7 | 4-22 | Revision 7 |
| 3-6 | Revision 7 | 4-23 | Revision 7 |
| 3-7 | Revision 8 | 4-24 | Revision 7 |
| 3-8 | Revision 7 | 4-25 | Revision 7 |
| 3-9 | Revision 7 | 4-26 | Revision 7 |
| 3-10 | Revision 4 | 4-27 | Revision 7 |
| 3-11 | Revision 7 | 4-28 | Revision 7 |
| 3-12 | Revision 7 | 4-29 | Revision 7 |
| 3-13 | Original Issue | 4-30 | Revision 7 |
| 3-14 | Revision 7 | 4-31 | Revision 7 |
| 3-15 | Revision 7 | 4-32 | Revision 7 |
| 3-16 | Revision 7 | 4-33 | Revision 7 |
| 3-17 | Revision 7 | 4-34 | Revision 7 |
| 3-18 | Revision 7 | 4-35 | Revision 7 |
| 3-19 | Revision 7 | 4-36 | Revision 7 |
| 3-20 | Revision 7 | 5-1/5-2 | Revision 8 |
| 3-21 | Revision 8 | 5-3 | Feb 28/00 |
| 3-22 | Revision 7 | 5-4 | Dec 2/96 |
| 3-23/3-24 | Revision 7 | 5-5 | Revision 7 |
| 4-1 | Revision 7 | 5-6 | Revision 7 |
| 4-2 | Revision 7 | 5-7 | Dec 2/96 |
| 4-3/4-4 | Revision 7 | 5-8 | Dec 2/96 |
| 4-5 | Revision 7 | 5-9 | Dec 2/96 |
| 4-6 | Revision 4 | 5-10 | Dec 2/96 |
| 4-7 | Revision 7 | 5-11 | Dec 2/96 |
| 4-8 | Revision 7 | 5-12 | Dec 2/96 |
| 4-9 | Revision 7 | 5-13 | Revision 7 |
| 4-10 | Revision 7 | 5-14 | Original Issue |
| 4-11 | Revision 7 | 5-15 | Dec 2/96 |
| 4-12 | Revision 8 | 5-16 | Dec 2/96 |
| 4-13 | Revision 8 | 5-17 | Dec 2/96 |
| 4-14 | Revision 8 | 5-18 | Dec 2/96 |
| 4-15 | Revision 8 | 5-19 | Feb 28/97 |
| 4-16 | Revision 7 | 5-20 | Feb 28/97 |
| 4-17 | Revision 7 | 5-21/5-22 | Revision 8 |

LOG OF EFFECTIVE PAGES
(Continued)

| <u>PAGE</u> | <u>DATE/REV</u> | <u>PAGE</u> | <u>DATE/REV</u> |
|-------------|-----------------|-------------|-----------------|
| 6-1/6-2 | Revision 8 | 7-17 | Feb 28/00 |
| 6-3 | Revision 7 | 7-18 | Feb 28/00 |
| 6-4 | Revision 2 | 7-19 | Revision 7 |
| 6-5 | Revision 2 | 7-20 | Revision 7 |
| 6-6 | Revision 7 | 7-21 | Revision 7 |
| 6-7 | Dec 2/96 | 7-22 | Revision 4 |
| 6-8 | Feb 28/00 | 7-23 | Feb 28/00 |
| 6-9 | Nov 3/97 | 7-24 | Revision 9 |
| 6-10 | Feb 28/00 | 7-25 | Feb 28/00 |
| 6-11 | Dec 2/96 | 7-26 | Feb 28/97 |
| 6-12 | Feb 28/00 | 7-27/7-27A | Revision 8 |
| 6-13 | Dec 2/96 | 7-27B | Revision 9 |
| 6-14 | Nov 3/97 | 7-28 | Feb 28/00 |
| 6-15 | Feb 28/00 | 7-29 | Feb 28/00 |
| 6-16 | Feb 28/00 | 7-30 | Dec 30/00 |
| 6-17 | Feb 28/00 | 7-30A | Revision 5 |
| 6-18 | Feb 28/00 | 7-30B | Revision 7 |
| 6-19 | Revision 7 | 7-31 | Dec 30/00 |
| 6-20 | Revision 7 | 7-32 | Revision 8 |
| 6-21 | Feb 28/00 | 7-33 | Revision 8 |
| 6-22 | Feb 28/00 | 7-34 | Revision 8 |
| 6-23 | Feb 28/00 | 7-35 | Revision 7 |
| 6-24 | Feb 28/00 | 7-36 | Revision 8 |
| 7-1 | Feb 28/00 | 7-37 | Original Issue |
| 7-2 | Feb 28/00 | 7-38 | Revision 8 |
| 7-3/7-4 | Revision 8 | 7-39 | Revision 8 |
| 7-5 | Feb 28/00 | 7-40 | Feb 28/97 |
| 7-6 | Dec 2/96 | 7-41 | Dec 2/96 |
| 7-7 | Dec 2/96 | 7-42 | Dec 2/96 |
| 7-8 | Dec 2/96 | 7-43 | Feb 28/00 |
| 7-9 | Revision 7 | 7-44 | Dec 2/96 |
| 7-10 | Revision 7 | 7-45 | Revision 8 |
| 7-11 | Revision 7 | 7-46 | Feb 28/00 |
| 7-12 | Revision 7 | 7-47 | Revision 8 |
| 7-13 | Revision 7 | 7-48 | Dec 2/96 |
| 7-14 | Revision 4 | 7-49 | Feb 28/00 |
| 7-15 | Mar 12/99 | 7-50 | Revision 8 |
| 7-16 | Revision 8 | | |

LOG OF EFFECTIVE PAGES
(Continued)

| <u>PAGE</u> | <u>DATE/REV</u> |
|-------------|-----------------|
| 8-1 | Feb 28/00 |
| 8-2 | Feb 28/00 |
| 8-3 | Revision 8 |
| 8-4 | Revision 8 |
| 8-5 | Feb 28/00 |
| 8-6 | Feb 28/00 |
| 8-7 | Feb 28/00 |
| 8-8 | Feb 28/00 |
| 8-9 | Feb 28/00 |
| 8-10 | Feb 28/00 |
| 8-11 | Feb 28/00 |
| 8-12 | Feb 28/00 |
| 8-13 | Feb 28/00 |
| 8-14 | Revision 8 |
| 8-15 | Revision 8 |
| 8-16 | Feb 28/00 |
| 8-17 | Feb 28/00 |
| 8-18 | Feb 28/00 |
| 8-19 | Feb 28/00 |
| 8-20 | Revision 8 |
| 8-21 | Feb 28/00 |
| 8-22 | Revision 8 |
| 8-23 | Revision 8 |
| 8-24 | Revision 8 |
| 9-1 | Feb 28/00 |
| 9-2 (Blank) | Dec 2/96 |

APPROVED BY

TAL APPROVED UNDER THE EASA 21 REGULATIONS
Cessna Aircraft Co.
Buckeye, Ohio 43086-0001

Richard D. Hildy [Signature]

DATE OF APPROVAL

07-19-06



Pilot's Operating Handbook
and
FAA Approved Airplane Flight Manual

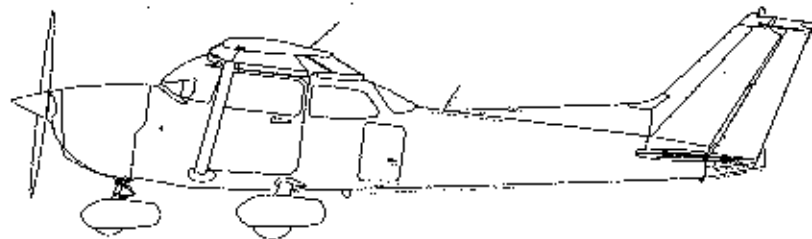

THIS PUBLICATION MUST BE
CARRIED IN THE AIRPLANE
AT ALL TIMES.

The Cessna Aircraft
Company

Model 172R

Serial No. 17280800

Registration No. N71755

This publication includes the material required to be furnished to the pilot by FAR Part 23 and constitutes the FAA Approved Airplane Flight Manual.

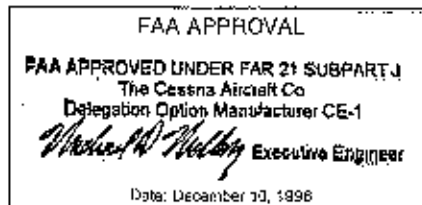

COPYRIGHT © 1996
The Cessna Aircraft Company
Wichita, Kansas USA

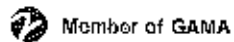

Original Issue - 2 December 1996

THIS MANUAL WAS PROVIDED FOR THE
AIRPLANE IDENTIFIED ON THE TITLE
PAGE ON 15 November 1999.
SUBSEQUENT REVISIONS SUPPLIED BY
THE CESSNA AIRCRAFT COMPANY
MUST BE PROPERLY INSERTED.

Mike Sharp

The Cessna Aircraft Company, Aircraft Division

CESSNA
MODEL 172R

PUBLICATION PART NUMBER

Pilot's Operating Handbook
and
FAA Approved Airplane Flight Manual

Serial Numbers 17280001 and On

Original Issue - 2 December 1996

Revision 8 - 12 August 2003

PART NUMBER: 172RPHUS08

CESSNA
MODEL 172R

CONGRATULATIONS

CONGRATULATIONS

Congratulations on your purchase and welcome to Cessna ownership! Your Cessna has been designed and constructed to give you the most in performance, value and comfort.

This Pilot's Operating Handbook has been prepared as a guide to help you get the most utility from your airplane. It contains information about your airplane's equipment, operating procedures, performance and suggested service and care. Please study it carefully and use it as a reference.

The worldwide Cessna Organization and Cessna Customer Service are prepared to serve you. The following services are offered by each Cessna Service Station:

- THE CESSNA AIRPLANE WARRANTIES, which provide coverage for parts and labor, are upheld through Cessna Service Stations worldwide. Warranty provisions and other important information are contained in the Customer Care Program Handbook supplied with your airplane. The Customer Care Card assigned to you at delivery will establish your eligibility under warranty and should be presented to your local Cessna Service Station at the time of warranty service.
- FACTORY TRAINED PERSONNEL to provide you with courteous, expert service.
- FACTORY APPROVED SERVICE EQUIPMENT to provide you efficient and accurate workmanship.
- A STOCK OF GENUINE CESSNA SERVICE PARTS are available when you need them.
- THE LATEST AUTHORITATIVE INFORMATION FOR SERVICING CESSNA AIRPLANES. Cessna Service Stations have all of the current Maintenance Manuals, Illustrated Parts Catalogs and various other support publications produced by Cessna Aircraft Company.

A current Cessna Service Station Directory accompanies your new airplane. The Directory is revised frequently, and a current copy can be obtained from your nearest Cessna Service Station.

We urge all Cessna owners/operators to utilize the benefits available within the Cessna Organization.

PERFORMANCE - SPECIFICATIONS

* SPEED:

Maximum at Sea Level 123 KNOTS
Cruise, 80% Power at 8000 FT 122 KNOTS

CRUISE: Recommended lean mixture with fuel allowance for engine start, taxi, takeoff, climb and 45 minutes reserve.

| | | |
|-------------------------------------|-------|---------|
| 80% Power at 8000 FT | Range | 580 NM |
| 53 Gallons Usable Fuel | Time | 4.8 HRS |
| Range at 10,000 FT, 60% power | Range | 687 NM |
| 53 Gallons Usable Fuel | Time | 6.6 HRS |

RATE OF CLIMB AT SEA LEVEL 720 FPM
SERVICE CEILING 13,500 FT

TAKEOFF PERFORMANCE:

Ground Roll 945 FT
Total Distance Over 50 FT Obstacle 1685 FT

LANDING PERFORMANCE:

Ground Roll 550 FT
Total Distance Over 50 FT Obstacle 1295 FT

STALL SPEED:

Flaps Up, Power Off 51 KCAS
Flaps Down, Power Off 47 KCAS

MAXIMUM WEIGHT:

Ramp 2457 LBS
Takeoff 2450 LBS
Landing 2450 LBS

STANDARD EMPTY WEIGHT 1639 LBS

MAXIMUM USEFUL LOAD 818 LBS

BAGGAGE ALLOWANCE 120 LBS

CESSNA
MODEL 172R

PERFORMANCE/SPECIFICATIONS

PERFORMANCE-SPECIFICATIONS

(Continued)

| | |
|--|------------|
| WING LOADING: Lbs/Sq Ft | 14.1 |
| POWER LOADING Lbs/HP | 15.3 |
| FUEL CAPACITY | 56 GAL |
| OIL CAPACITY | .8 QTS |
| ENGINE: Textron Lycoming | IO-360-L2A |
| 160 BHP at 2400 RPM | |
| PROPELLER: Fixed Pitch, Diameter | 75 IN. |

* NOTE

Speed performance is shown for an airplane equipped with speed fairings which increase the speeds by approximately 2 knots. There is a corresponding difference in range, while all other performance figures are unchanged when speed fairings are installed.

The above performance figures are based on airplane weights at 2450 pounds, standard atmospheric conditions, level, hard-surfaced dry runways and no wind. They are calculated values derived from flight tests conducted by The Cessna Aircraft Company under carefully documented conditions and will vary with individual airplanes and numerous factors affecting flight performance.

COVERAGE

The Pilot's Operating Handbook in the airplane at the time of delivery from The Cessna Aircraft Company contains information applicable to the Model 172R airplane by serial number and registration number shown on the Title Page. This handbook is applicable to airplane serial number 17280001 and On. All information is based on data available at the time of publication.

This handbook is comprised of nine sections that cover all operational aspects of a standard-equipped airplane. Following Section 8 are the Supplements, Section 9, which provide expanded operational procedures for the avionics equipment (both standard and optional), and provides information on special operations.

Supplements are individual documents, and may be issued or revised without regard to revision dates which apply to the POH itself. These supplements contain a Log of Effective Pages, which should be used to determine the status of each supplement.

ORIGINAL ISSUE AND REVISIONS

This Pilot's Operating Handbook and FAA Approved Airplane Flight Manual is comprised of the original issue and any subsequent revisions. To ensure that information in this manual is current, the revisions must be incorporated as they are issued. This manual was originally issued on December 2, 1996. As revisions are issued, they will be noted in the Log of Effective Pages table.

The part number of this manual has also been designed to further aid the owner/operator in determining the revision level of any POH. Refer to the example below for a breakdown:

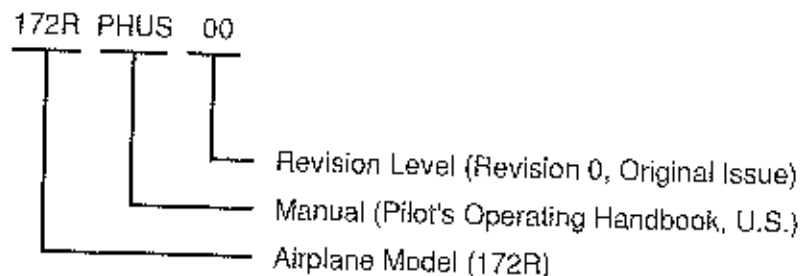

It is the responsibility of the owner to maintain this handbook in a current status when it is being used for operational purposes. Owners should contact their local Cessna Service Station whenever the revision status of their handbook is in question.

Revisions are distributed to owners of U.S. Registered aircraft according to FAA records at the time of revision issuance, and to Internationally Registered aircraft according to Cessna Owner Advisory records at the time of issuance. Revisions should be read carefully upon receipt and incorporated in this POH.

REVISION FILING INSTRUCTIONS

REGULAR REVISIONS

Pages to be removed or inserted in the Pilots' Operating Handbook and FAA Approved Airplane Flight Manual are determined by the Log of Effective Pages located in this section. This log contains the page number and date of issue for each page within the POH. At original issue, all pages will contain the same date. As revisions to the POH occur, these dates will change on effected pages. When two pages display the same page number, the page with the latest date shall be inserted into the POH. The date on the Log Of Effective Pages shall also agree with the latest date of the page in question.

TEMPORARY REVISIONS

Under limited circumstances, temporary revisions to the POH may be issued. These temporary revisions are to be filed in the applicable section in accordance with filing instructions appearing on the first page of the temporary revision.

The recession of a temporary revision is accomplished by incorporation into the POH at revision time or by a superseding temporary revision. In order to accurately track the status of temporary revisions as they pertain to a POH, a Temporary Revision List will be located previous to this section when required. This list will indicate the date the temporary revision was incorporated into the POH, thus authorizing the recession of the temporary revision.

IDENTIFYING REVISED MATERIAL

Additions or revisions to the text in an existing section will be identified by a vertical line (revision bar) adjacent to the applicable revised area on the outer margin of the page.

When technical changes cause unchanged text to appear on a different page, a revision bar will be placed in the outer lower margin of the page, opposite the page number and date of the page, providing no other revision bar appears on the page. These pages will display the current revision date as found in the Original Issue and Revisions paragraph of this section.

When extensive technical changes are made to text in an existing section that requires extensive revision, revision bars will appear the full length of text.

New art added to an existing section will be identified by a single pointing hand indicator adjacent to the figure title and figure number. Existing art which is revised will have a pointing hand adjacent to the portion of the art which has changed.

WARNINGS, CAUTIONS AND NOTES

Throughout the text, warnings, cautions and notes pertaining to airplane handling and operations are utilized. These adjuncts to the text are used to highlight or emphasize important points.

WARNING - Calls attention to use of methods, procedures or limits which must be followed precisely to avoid injury or death to persons.

CAUTION - Calls attention to methods, procedures or limits which must be followed to avoid damage to equipment.

NOTE - Calls attention to additional procedures or information pertaining to the text.

LOG OF EFFECTIVE PAGES

The following Log of Effective Pages provides the date of issue for original and revised pages, as well as a listing of all pages in the POH. Pages which are affected by the current revision will be preceded by an asterisk with the revision level.

| <u>Revision Level</u> | <u>Date of Issue</u> | <u>Revision Level</u> | <u>Date of Issue</u> |
|-----------------------|----------------------|-----------------------|----------------------|
| 0 (Original Issue) | Dec 2, 1996 | 5 | Dec 30, 2000 |
| 1 | Feb 28, 1997 | 6 | Mar 2, 2001 |
| 2 | Nov 3, 1997 | 7 | Mar 25, 2003 |
| 3 | Mar 12, 1999 | 8 | Aug 12, 2003 |
| 4 | Feb 28, 2000 | | |

| <u>PAGE</u> | <u>DATE/REV</u> | <u>PAGE</u> | <u>DATE/REV</u> |
|-------------------------|-----------------|-------------------|-----------------|
| Title | Dec 2/96 | | |
| Assignment Record | Dec 2/96 | 1-15 | Feb 28/97 |
| * iii | Revision 8 | 1-16 | Feb 28/00 |
| iii | Dec 2/96 | 1-17 | Revision 7 |
| iv | Feb 28/00 | 1-18 | Revision 4 |
| * v | Revision 8 | 1-19 | Revision 7 |
| vi | Feb 28/00 | 1-20 | Revision 7 |
| vii | Feb 28/00 | 1-21 | Feb 28/00 |
| viii | Dec 2/96 | 1-22 | Feb 28/00 |
| * ix | Revision 8 | 1-23 | Feb 28/00 |
| x | Revision 8 | 1-24 | Nov 3/97 |
| * xi | Revision 8 | 1-25 | Revision 7 |
| * xii | Revision 8 | 1-26 | Revision 7 |
| * xlii/xiv | Revision 8 | 1-27/1-28 | Revision 7 |
| 1-1 | Revision 7 | * 2-1/2-2 | Revision 8 |
| 1-2 | Revision 7 | 2-3 | Revision 4 |
| 1-3 | Revision 7 | 2-4 | Revision 7 |
| 1-4 | Revision 7 | 2-5 | Revision 7 |
| 1-5 | Revision 7 | 2-6 | Revision 7 |
| 1-6 | Revision 7 | 2-7 | Dec 2/96 |
| 1-7 | Revision 7 | 2-8 | Dec 2/96 |
| 1-8 | Original Issue | 2-9 | Original Issue |
| * 1-9 | Revision 8 | 2-10 | Revision 7 |
| 1-10 | Revision 7 | 2-11 | Original Issue |
| 1-11 | Revision 7 | 2-12 | Revision 7 |
| 1-12 | Revision 7 | 2-13 | Original Issue |
| 1-13 | Revision 4 | 2-14 | Revision 7 |
| 1-14 | Revision 7 | * 2-15/2-16 | Revision 8 |

LOG OF EFFECTIVE PAGES
(Continued)

| <u>PAGE</u> | <u>DATE/REV</u> | <u>PAGE</u> | <u>DATE/REV</u> |
|-------------|-----------------|-------------|-----------------|
| 3-1 | Revision 7 | 4-18 | Revision 4 |
| 3-2 | Revision 7 | 4-19 | Revision 7 |
| 3-3 | Revision 4 | 4-20 | Revision 7 |
| 3-4 | Revision 7 | 4-21 | Revision 7 |
| 3-5 | Revision 7 | 4-22 | Revision 7 |
| 3-6 | Revision 7 | 4-23 | Revision 7 |
| * 3-7 | Revision 8 | 4-24 | Revision 7 |
| 3-8 | Revision 7 | 4-25 | Revision 7 |
| 3-9 | Revision 7 | 4-26 | Revision 7 |
| 3-10 | Revision 4 | 4-27 | Revision 7 |
| 3-11 | Revision 7 | 4-28 | Revision 7 |
| 3-12 | Revision 7 | 4-29 | Revision 7 |
| 3-13 | Original Issue | 4-30 | Revision 7 |
| 3-14 | Revision 7 | 4-31 | Revision 7 |
| 3-15 | Revision 7 | 4-32 | Revision 7 |
| 3-16 | Revision 7 | 4-33 | Revision 7 |
| 3-17 | Revision 7 | 4-34 | Revision 7 |
| 3-18 | Revision 7 | 4-35 | Revision 7 |
| 3-19 | Revision 7 | 4-36 | Revision 7 |
| 3-20 | Revision 7 | * 5-1/5-2 | Revision 8 |
| * 3-21 | Revision 8 | 5-3 | Feb 28/00 |
| 3-22 | Revision 7 | 5-4 | Dec 2/96 |
| 3-23/3-24 | Revision 7 | 5-5 | Revision 7 |
| 4-1 | Revision 7 | 5-6 | Revision 7 |
| 4-2 | Revision 7 | 5-7 | Dec 2/96 |
| 4-3/4-4 | Revision 7 | 5-8 | Dec 2/96 |
| 4-5 | Revision 7 | 5-9 | Dec 2/96 |
| 4-6 | Revision 4 | 5-10 | Dec 2/96 |
| 4-7 | Revision 7 | 5-11 | Dec 2/96 |
| 4-8 | Revision 7 | 5-12 | Dec 2/96 |
| 4-9 | Revision 7 | 5-13 | Dec 2/96 |
| 4-10 | Revision 7 | 5-14 | Revision 7 |
| 4-11 | Revision 7 | 5-15 | Original Issue |
| * 4-12 | Revision 8 | 5-16 | Dec 2/96 |
| * 4-13 | Revision 8 | 5-17 | Dec 2/96 |
| * 4-14 | Revision 8 | 5-18 | Dec 2/96 |
| * 4-15 | Revision 8 | 5-19 | Dec 2/96 |
| 4-16 | Revision 7 | 5-20 | Feb 28/97 |
| 4-17 | Revision 7 | * 5-21/5-22 | Feb 28/97 |
| | | | Revision 8 |

LOG OF EFFECTIVE PAGES
(Continued)

| <u>PAGE</u> | <u>DATE/REV</u> | <u>PAGE</u> | <u>DATE/REV</u> |
|----------------------|-----------------|--------------|-----------------|
| ^A 6-1/6-2 | Revision 8 | 7-17 | Feb 28/00 |
| 6-3 | Revision 7 | 7-18 | Feb 28/00 |
| 6-4 | Revision 2 | 7-19 | Revision 7 |
| 6-5 | Revision 2 | 7-20 | Revision 7 |
| 6-6 | Revision 7 | 7-21 | Revision 7 |
| 6-7 | Dec 2/96 | 7-22 | Revision 4 |
| 6-8 | Feb 28/00 | 7-23 | Feb 28/00 |
| 6-9 | Nov 3/97 | * 7-24 | Revision 8 |
| 6-10 | Feb 28/00 | 7-25 | Feb 28/00 |
| 6-11 | Dec 2/96 | 7-26 | Feb 28/97 |
| 6-12 | Feb 28/00 | * 7-27/7-27A | Revision 8 |
| 6-13 | Dec 2/96 | * 7-27B | Revision 8 |
| 6-14 | Nov 3/97 | 7-28 | Feb 28/00 |
| 6-15 | Feb 28/00 | 7-29 | Feb 28/00 |
| 6-16 | Feb 28/00 | 7-30 | Dec 30/00 |
| 6-17 | Feb 28/00 | 7-30A | Revision 5 |
| 6-18 | Feb 28/00 | 7-30B | Revision 7 |
| 6-19 | Revision 7 | 7-31 | Dec 30/00 |
| 6-20 | Revision 7 | * 7-32 | Revision 8 |
| 6-21 | Feb 28/00 | * 7-33 | Revision 8 |
| 6-22 | Feb 28/00 | * 7-34 | Revision 8 |
| 6-23 | Feb 28/00 | 7-35 | Revision 7 |
| 6-24 | Feb 28/00 | * 7-36 | Revision 8 |
| 7-1 | Feb 28/00 | 7-37 | Original Issue |
| 7-2 | Feb 28/00 | * 7-38 | Revision 8 |
| ^A 7-3/7-4 | Revision 8 | * 7-39 | Revision 8 |
| 7-5 | Feb 28/00 | 7-40 | Feb 28/97 |
| 7-6 | Dec 2/96 | 7-41 | Dec 2/96 |
| 7-7 | Dec 2/96 | 7-42 | Dec 2/96 |
| 7-8 | Dec 2/96 | 7-43 | Feb 28/00 |
| 7-9 | Revision 7 | 7-44 | Dec 2/96 |
| 7-10 | Revision 7 | * 7-45 | Revision 8 |
| 7-11 | Revision 7 | 7-46 | Feb 28/00 |
| 7-12 | Revision 7 | * 7-47 | Revision 8 |
| 7-13 | Revision 7 | 7-48 | Dec 2/96 |
| 7-14 | Revision 4 | 7-49 | Feb 28/00 |
| 7-15 | Mar 12/99 | * 7-50 | Revision 8 |
| ^A 7-16 | Revision 8 | | |

LOG OF EFFECTIVE PAGES

(Continued)

| <u>PAGE</u> | <u>DATE/REV</u> |
|-------------------|-----------------|
| 8-1 | Feb 28/00 |
| 8-2 | Feb 28/00 |
| * 8-3 | Revision 8 |
| * 8-4 | Revision 8 |
| 8-5 | Feb 28/00 |
| 8-6 | Feb 28/00 |
| 8-7 | Feb 28/00 |
| 8-8 | Feb 28/00 |
| 8-9 | Feb 28/00 |
| 8-10 | Feb 28/00 |
| 8-11 | Feb 28/00 |
| 8-12 | Feb 28/00 |
| 8-13 | Feb 28/00 |
| * 8-14 | Revision 8 |
| * 8-15 | Revision 8 |
| 8-16 | Feb 28/00 |
| 8-17 | Feb 28/00 |
| 8-18 | Feb 28/00 |
| 8-19 | Feb 28/00 |
| * 8-20 | Revision 8 |
| 8-21 | Feb 28/00 |
| * 8-22 | Revision 8 |
| * 8-23 | Revision 8 |
| * 8-24 | Revision 8 |
| 9-1 | Feb 28/00 |
| 9-2 (Blank) | Dec 2/96 |

APPROVED BY

EAA APPROVED UNDER FAR 21 (2)(b) PART J
 The Cessna Aircraft Co.
 Delegation of Authority Authorization DCA-100128-CE
Michael D. Hickey *Ernest R. ...*

DATE OF APPROVAL 08-12-03

TABLE OF CONTENTS

| | SECTION |
|---------------------------------------|---------|
| GENERAL | 1 |
| LIMITATIONS | 2 |
| EMERGENCY PROCEDURES | 3 |
| NORMAL PROCEDURES | 4 |
| PERFORMANCE | 5 |
| WEIGHT & BALANCE/EQUIPMENT LIST | 6 |
| AIRPLANE & SYSTEMS DESCRIPTION | 7 |
| HANDLING, SERVICE & MAINTENANCE | 8 |
| SUPPLEMENTS | 9 |

METEOROLOGICAL TERMINOLOGY

| | |
|----------------------|--|
| OAT | Outside Air Temperature is the free air static temperature. It may be expressed in either degrees Celsius or degrees Fahrenheit. |
| Standard Temperature | Standard Temperature is 15°C at sea level pressure altitude and decreases by 2°C for each 1000 feet of altitude. |
| Pressure Altitude | Pressure Altitude is the altitude read from an altimeter when the altimeter's barometric scale has been set to 29.92 inches of mercury (1013 mb). |

ENGINE POWER TERMINOLOGY

| | |
|--------------|---|
| BHP | Brake Horsepower is the power developed by the engine. |
| RPM | Revolutions Per Minute is engine speed. |
| Static RPM | Static RPM is engine speed attained during a full throttle engine runup when the airplane is on the ground and stationary. |
| MAP | Manifold Absolute Pressure is the absolute pressure measured in the engine induction system. MAP is measured in units of inches of mercury (inHG). |
| Lean Mixture | Decreased proportion of fuel in the fuel-air mixture supplied to the engine. As air density decreases, the amount of fuel required by the engine decreases for a given throttle setting. Adjusting the fuel-air mixture to provide a smaller portion of fuel is known as "leaning" the mixture. |
| Rich Mixture | Increased proportion of fuel in the fuel-air mixture supplied to the engine. As air density increases, the amount of fuel required by the engine increases for a given throttle setting. Adjusting the fuel-air mixture to provide a greater portion of fuel is known as "richening" the mixture. |
| Full Rich | Mixture control full forward (pushed in, full control travel, toward the panel). |
| Idle Cutoff | Mixture control full aft (pulled out, full control travel, away from the panel). |

ENGINE POWER TERMINOLOGY (Continued)

| | |
|-----------------|---|
| Full Throttle | Throttle full forward (pushed in, full control travel, toward the panel). Also known as "full open" throttle. |
| Closed Throttle | Throttle full aft (pulled out, full control travel, away from the panel). Also known as the throttle "idle" position. |

AIRPLANE PERFORMANCE AND FLIGHT PLANNING TERMINOLOGY

| | |
|---------------------------------|---|
| Demonstrated Crosswind Velocity | Demonstrated Crosswind Velocity is the velocity of the crosswind component for which adequate control of the airplane during takeoff and landing was actually demonstrated during certification tests. The value shown is not considered to be limiting. |
| Usable Fuel | Usable Fuel is the fuel available for flight planning. |
| Unusable Fuel | Unusable Fuel is the quantity of fuel that can not be safely used in flight. |
| GPH | Gallons Per Hour is the amount of fuel consumed per hour. |
| NMPG | Nautical Miles Per Gallon is the distance which can be expected per gallon of fuel consumed at a specific engine power setting and/or flight configuration. |
| g | g is acceleration due to gravity. |
| Course Datum | Course Datum is the compass reference used by the autopilot, along with course deviation, to provide lateral control when tracking a navigation signal. |

1. The first part of the document discusses the importance of maintaining accurate records of all transactions and activities. It emphasizes that this is crucial for ensuring transparency and accountability in the organization's operations.

2. The second part of the document outlines the various methods and tools used to collect and analyze data. It highlights the need for consistent data collection procedures and the use of advanced analytical techniques to derive meaningful insights from the data.

3. The third part of the document focuses on the role of technology in data management and analysis. It discusses how modern software solutions can streamline data collection, storage, and processing, thereby improving efficiency and accuracy.

4. The fourth part of the document addresses the challenges associated with data management, such as data quality, security, and privacy. It provides strategies to mitigate these risks and ensure that the data remains reliable and secure throughout its lifecycle.

5. The fifth part of the document concludes by summarizing the key findings and recommendations. It stresses the importance of ongoing monitoring and evaluation to ensure that the data management processes remain effective and aligned with the organization's goals.

GENERAL

1

SECTION 1 GENERAL

| TABLE OF CONTENTS | Page |
|--|-----------|
| Three View - Normal Ground Attitude | 1-2 |
| Introduction | 1-4 |
| Descriptive Data | 1-4 |
| Engine | 1-4 |
| Propeller | 1-4 |
| Fuel | 1-4 |
| Oil | 1-5 |
| Maximum Certificated Weights | 1-6 |
| Standard Airplane Weights | 1-7 |
| Cabin And Entry Dimensions | 1-7 |
| Baggage Space and Entry Dimensions | 1-7 |
| Specific Loadings | 1-7 |
| Symbols, Abbreviations and Terminology | 1-8 |
| General Airspeed Terminology And Symbols | 1-8 |
| Meteorological Terminology | 1-9 |
| Engine Power Terminology | 1-9 |
| Airplane Performance And Flight Planning Terminology | 1-10 |
| Weight And Balance Terminology | 1-11 |
| Metric / Imperial / U.S. Conversion Charts | 1-13 |
| Weight Conversions | 1-14 |
| Length Conversions | 1-16 |
| Distance Conversions | 1-20 |
| Volume Conversions | 1-21 |
| Temperature Conversions | 1-24 |
| Hectopascals to Inches Mercury Conversions | 1-25 |
| Volume to Weight Conversions | 1-26 |
| Quick Conversions | 1-27/1-28 |

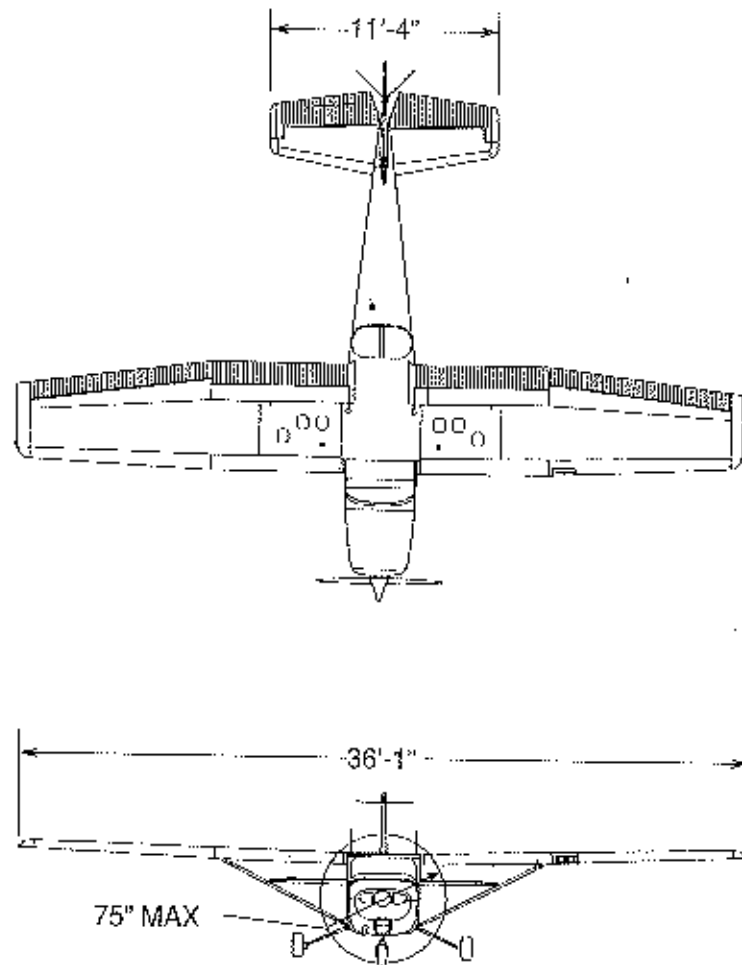

0510T1005
0510T1005

Figure 1-1. Three View - Normal Ground Attitude (Sheet 1 of 2)

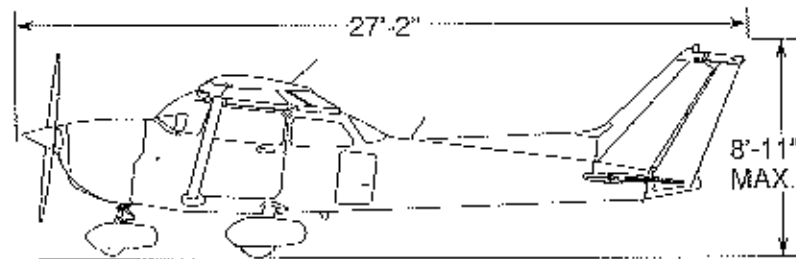

NOTE 1: WING SPAN SHOWN WITH STROBE LIGHTS INSTALLED.

NOTE 2: WHEEL BASE LENGTH IS 65\".

NOTE 3: PROPELLER GROUND CLEARANCE IS 11 1/4\".

NOTE 4: WING AREA IS 174 SQUARE FEET.

NOTE 5: MINIMUM TURNING RADIUS (PIVOT POINT TO OUTBOARD WING TIP) IS 27'-5 1/2\".

NOTE 6: NORMAL GROUND ATTITUDE IS SHOWN WITH NOSE STRUT SHOWING APPROXIMATELY 2\" OF STRUT, AND WINGS LEVEL.

0510T1005

Figure 1-1. Three View - Normal Ground Attitude (Sheet 2)

INTRODUCTION

- This handbook contains 9 sections, and includes the material required to be furnished to the pilot by FAR Part 23. It also contains
- supplemental data supplied by Cessna Aircraft Company.

Section 1 provides basic data and information of general interest. It also contains definitions or explanations of symbols, abbreviations, and terminology commonly used.

DESCRIPTIVE DATA

ENGINE

Number of Engines: 1.
Engine Manufacturer: Textron Lycoming.
Engine Model Number: IO-360-L2A.
Engine Type: Normally aspirated, direct drive, air-cooled, horizontally opposed, fuel injected, four cylinder engine with 360 cu. in. displacement.
Horsepower Rating and Engine Speed: 160 rated BHP at 2400 RPM.

PROPELLER

Propeller Manufacturer: McCauley Propeller Systems.
Propeller Model Number: 1C235/LFA7570.
Number of Blades: 2.
Propeller Diameter: 75 inches.
Propeller Type: Fixed pitch.

FUEL

WARNING

USE OF UNAPPROVED FUELS MAY RESULT IN DAMAGE TO THE ENGINE AND FUEL SYSTEM COMPONENTS, RESULTING IN POSSIBLE ENGINE FAILURE.

Approved Fuel Grades (and Colors):
100LL Grade Aviation Fuel (Blue).
100 Grade Aviation Fuel (Green).

NOTE

Isopropyl alcohol or diethylene glycol monomethyl ether (DiEGME) may be added to the fuel supply. Additive concentrations shall not exceed 1% for isopropyl alcohol or 0.10% to 0.15% for DiEGME. Refer to Section 8 for additional information.

Fuel Capacity:

Total Capacity: 56.0 U.S. gallons.
Total Usable: 53.0 U.S. gallons.

Total Capacity Each Tank: 28.0 U.S. gallons.
Total Usable Each Tank: 26.5 U.S. gallons.

NOTE

To ensure maximum fuel capacity and minimize cross-feeding when refueling, always park the airplane in a wings-level, normal ground attitude and place the fuel selector in the Left or Right position. Refer to Figure 1-1 for normal ground attitude dimensions.

OIL

Oil Specification:

MIL-L-6082 or SAE J1966 Aviation Grade Straight Mineral Oil: Used when the airplane was delivered from the factory and should be used to replenish the supply during the first 25 hours. This oil should be drained and the filter changed after the first 25 hours of operation. Refill the engine with MIL-L-6082 or SAE J1966 Aviation Grade Straight Mineral Oil and continue to use until a total of 50 hours has accumulated or oil consumption has stabilized.

MIL-L-22851 or SAE J1899 Aviation Grade Ashless Dispersant Oil: Oil conforming to the latest revision and/or supplements to Textron Lycoming Service Instruction No. 1014, **must be used** after first 50 hours or once oil consumption has stabilized.

Recommended Viscosity for Temperature Range:

| Temperature | MIL-L-6082 or SAE J1966 Straight Mineral Oil SAE Grade | MIL-L-22851 or SAE J1899 Ashless Dispersant SAE Grade |
|----------------------------|---|--|
| Above 27°C (80°F) | 60 | 60 |
| Above 16°C (60°F) | 50 | 40 or 50 |
| -1°C (30°F) to 32°C (90°F) | 40 | 40 |
| -18°C (0°F) to 21°C (70°F) | 30 | 30, 40 or 20W-40 |
| Below -12°C (10°F) | 20 | 30 or 20W-30 |
| -18°C (0°F) to 32°C (90°F) | 20W-50 | 20W-50 or 15W-50 |
| All Temperatures | --- | 15W-50 or 20W-50 |

NOTE

When operating temperatures overlap, use the lighter grade of oil.

Oil Capacity:

Sump: 8 U.S. Quarts

Total: 9 U.S. Quarts

MAXIMUM CERTIFICATED WEIGHTS

| | | |
|----------------|-------------------|-----------|
| Ramp Weight | Normal Category: | 2457 lbs. |
| | Utility Category: | 2107 lbs. |
| Takeoff Weight | Normal Category: | 2450 lbs. |
| | Utility Category: | 2100 lbs. |
| Landing Weight | Normal Category: | 2450 lbs. |
| | Utility Category: | 2100 lbs. |

SEE
ETC

Weight in Baggage Compartment, Normal Category:

Baggage Area 1 (Station 82 to 108): 120 lbs. See note below.
Baggage Area 2 (Station 108 to 142): 50 lbs. See note below.

NOTE

The maximum combined weight capacity for Baggage Area 1 and Baggage Area 2 is 120 lbs.

Weight in Baggage Compartment, Utility Category:

In this category, the rear seat must not be occupied and the baggage compartment must be empty.

STANDARD AIRPLANE WEIGHTS

Standard Empty Weight: 1639 lbs.
Maximum Useful Load, Normal Category: 818 lbs.
Maximum Useful Load, Utility Category : 468 lbs.

CABIN AND ENTRY DIMENSIONS

Detailed dimensions of the cabin interior and entry door openings are illustrated in Section 6.

BAGGAGE SPACE AND ENTRY DIMENSIONS

Dimensions of the baggage area and baggage door opening are illustrated in detail in Section 6.

SPECIFIC LOADINGS

Wing Loading: 14.1 lbs./sq. ft.
Power Loading: 15.3 lbs./hp.

SYMBOLS, ABBREVIATIONS AND TERMINOLOGY

GENERAL AIRSPEED TERMINOLOGY AND SYMBOLS

| | |
|-----------------|--|
| KCAS | Knots Calibrated Airspeed is indicated airspeed corrected for position and instrument error and expressed in knots. Knots calibrated airspeed is equal to KTAS in standard atmosphere at sea level. |
| KIAS | Knots Indicated Airspeed is the speed shown on the airspeed indicator and expressed in knots. |
| KTAS | Knots True Airspeed is the airspeed expressed in knots relative to undisturbed air which is KCAS corrected for altitude and temperature. |
| V _A | Maneuvering Speed is the maximum speed at which full or abrupt control movements may be used without overstressing the airframe. |
| V _{FE} | Maximum Flap Extended Speed is the highest speed permissible with wing flaps in a prescribed extended position. |
| V _{NO} | Maximum Structural Cruising Speed is the speed that should not be exceeded except in smooth air, then only with caution. |
| V _{NE} | Never Exceed Speed is the speed limit that may not be exceeded at any time. |
| V _S | Stalling Speed or the minimum steady flight speed is the minimum speed at which the airplane is controllable. |
| V _{SO} | Stalling Speed or the minimum steady flight speed is the minimum speed at which the airplane is controllable in the landing configuration at the most forward center of gravity. |
| V _X | Best Angle-of-Climb Speed is the speed which results in the greatest gain of altitude in a given horizontal distance. |
| V _Y | Best Rate-of-Climb Speed is the speed which results in the greatest gain in altitude in a given time. |

METEOROLOGICAL TERMINOLOGY

| | |
|----------------------|--|
| OAT | Outside Air Temperature is the free air static temperature. It may be expressed in either degrees Celsius or degrees Fahrenheit. |
| Standard Temperature | Standard Temperature is 15°C at sea level pressure altitude and decreases by 2°C for each 1000 feet of altitude. |
| Pressure Altitude | Pressure Altitude is the altitude read from an altimeter when the altimeter's barometric scale has been set to 29.92 inches of mercury (1013 mb). |

ENGINE POWER TERMINOLOGY

| | |
|--------------|---|
| BHP | Brake Horsepower is the power developed by the engine. |
| RPM | Revolutions Per Minute is engine speed. |
| Static RPM | Static RPM is engine speed attained during a full throttle engine runup when the airplane is on the ground and stationary. |
| MAP | Manifold Absolute Pressure is the absolute pressure measured in the engine induction system. MAP is measured in units of inches of mercury (inHG). |
| Lean Mixture | Decreased proportion of fuel in the fuel-air mixture supplied to the engine. As air density decreases, the amount of fuel required by the engine decreases for a given throttle setting. Adjusting the fuel-air mixture to provide a smaller portion of fuel is known as "leaning" the mixture. |
| Rich Mixture | Increased proportion of fuel in the fuel-air mixture supplied to the engine. As air density increases, the amount of fuel required by the engine increases for a given throttle setting. Adjusting the fuel-air mixture to provide a greater portion of fuel is known as "richening" the mixture. |
| Full Rich | Mixture control full forward (pushed in, full control travel, toward the panel). |
| Idle Cutoff | Mixture control full aft (pulled out, full control travel, toward the panel). |

ENGINE POWER TERMINOLOGY (Continued)

| | |
|-----------------|---|
| Full Throttle | Throttle full forward (pushed in, full control travel, toward the panel). Also known as "full open" throttle. |
| Closed Throttle | Throttle full aft (pulled out, full control travel, away from the panel). Also known as the throttle "idle" position. |

AIRPLANE PERFORMANCE AND FLIGHT PLANNING TERMINOLOGY

| | |
|---------------------------------|---|
| Demonstrated Crosswind Velocity | Demonstrated Crosswind Velocity is the velocity of the crosswind component for which adequate control of the airplane during takeoff and landing was actually demonstrated during certification tests. The value shown is not considered to be limiting. |
| Usable Fuel | Usable Fuel is the fuel available for flight planning. |
| Unusable Fuel | Unusable Fuel is the quantity of fuel that can not be safely used in flight. |
| GPH | Gallons Per Hour is the amount of fuel consumed per hour. |
| NMPG | Nautical Miles Per Gallon is the distance which can be expected per gallon of fuel consumed at a specific engine power setting and/or flight configuration. |
| g | g is acceleration due to gravity. |
| Course Datum | Course Datum is the compass reference used by the autopilot, along with course deviation, to provide lateral control when tracking a navigation signal. |

WEIGHT AND BALANCE TERMINOLOGY

| | |
|--------------------------|--|
| Reference Datum | Reference Datum is an imaginary vertical plane from which all horizontal distances are measured for balance purposes. |
| Station | Station is a location along the airplane fuselage given in terms of the distance from the reference datum. |
| Arm | Arm is the horizontal distance from the reference datum to the center of gravity (C.G.) of an item. |
| Moment | Moment is the product of the weight of an item multiplied by its arm. (Moment divided by the constant 1000 is used in this handbook to simplify balance calculations by reducing the number of digits.) |
| Center of Gravity (C.G.) | Center of Gravity is the point at which an airplane, or equipment, would balance if suspended. Its distance from the reference datum is found by dividing the total moment by the total weight of the airplane. |

WEIGHT AND BALANCE TERMINOLOGY (Continued)

| | |
|------------------------|--|
| C.G. Arm | Center of Gravity Arm is the arm obtained by adding the airplane's individual moments and dividing the sum by the total weight. |
| C.G. Limits | Center of Gravity Limits are the extreme center of gravity locations within which the airplane must be operated at a given weight. |
| Standard Empty Weight | Standard Empty Weight is the weight of a standard airplane, including unusable fuel, full operating fluids and full engine oil. |
| Basic Empty Weight | Basic Empty Weight is the standard empty weight plus the weight of optional equipment. |
| Useful Load | Useful Load is the difference between ramp weight and the basic empty weight. |
| MAC | MAC (Mean Aerodynamic Chord) is the chord of an imaginary rectangular airfoil having the same pitching moments throughout the flight range as that of the actual wing. |
| Maximum Ramp Weight | Maximum Ramp Weight is the maximum weight approved for ground maneuver, and includes the weight of fuel used for start, taxi and runup. |
| Maximum Takeoff Weight | Maximum Takeoff Weight is the maximum weight approved for the start of the takeoff roll. |
| Maximum Landing Weight | Maximum Landing Weight is the maximum weight approved for the landing touchdown. |
| Tare | Tare is the weight of chocks, blocks, stands, etc. used when weighing an airplane, and is included in the scale readings. Tare is deducted from the scale reading to obtain the actual (net) airplane weight. |

METRIC / IMPERIAL / U.S. CONVERSION CHARTS

The following charts have been provided to help international operators convert U.S. measurement supplied with the Pilot's Operating Handbook into metric and imperial measurements.

The standard followed for measurement units shown, is the National Institute of Standards Technology (NIST), Publication 811, "Guide for the Use of the International System of Units (SI)."

Please refer to the following pages for these charts.

(Kilograms x 2.205 = Pounds) (Pounds x .454 = Kilograms)

**KILOGRAMS INTO POUNDS
KILOGRAMMES EN LIVRES**

| kg | 0 | 1 | 2 | 3 | 4 | 5 | 6 | 7 | 8 | 9 |
|-----|--------|--------|--------|--------|--------|--------|--------|--------|--------|--------|
| | lb. | lb. | lb. | lb. | lb. | lb. | lb. | lb. | lb. | lb. |
| 0 | | 2.205 | 4.409 | 6.614 | 8.819 | 11.023 | 13.228 | 15.432 | 17.637 | 19.842 |
| 10 | 22.046 | 24.251 | 26.456 | 28.660 | 30.865 | 33.069 | 35.274 | 37.479 | 39.683 | 41.888 |
| 20 | 44.093 | 46.297 | 48.502 | 50.706 | 52.911 | 55.116 | 57.320 | 59.525 | 61.729 | 63.934 |
| 30 | 66.139 | 68.343 | 70.548 | 72.753 | 74.957 | 77.162 | 79.366 | 81.571 | 83.776 | 85.980 |
| 40 | 88.185 | 90.390 | 92.594 | 94.799 | 97.003 | 99.208 | 101.41 | 103.62 | 105.82 | 108.03 |
| 50 | 110.23 | 112.44 | 114.64 | 116.85 | 119.05 | 121.26 | 123.46 | 125.66 | 127.87 | 130.07 |
| 60 | 132.28 | 134.48 | 136.69 | 138.89 | 141.10 | 143.30 | 145.51 | 147.71 | 149.91 | 152.12 |
| 70 | 154.32 | 156.53 | 158.73 | 160.94 | 163.14 | 165.35 | 167.55 | 169.76 | 171.96 | 174.17 |
| 80 | 176.37 | 178.57 | 180.78 | 182.98 | 185.19 | 187.39 | 189.60 | 191.80 | 194.01 | 196.21 |
| 90 | 198.42 | 200.62 | 202.83 | 205.03 | 207.24 | 209.44 | 211.64 | 213.85 | 216.05 | 218.26 |
| 100 | 220.46 | 222.67 | 224.87 | 227.08 | 229.28 | 231.49 | 233.69 | 235.90 | 238.10 | 240.30 |

**POUNDS INTO KILOGRAMS
LIVRES EN KILOGRAMMES**

| lb. | 0 | 1 | 2 | 3 | 4 | 5 | 6 | 7 | 8 | 9 |
|-----|--------|--------|--------|--------|--------|--------|--------|--------|--------|--------|
| | kg | kg | kg | kg | kg | kg | kg | kg | kg | kg |
| 0 | | 0.454 | 0.907 | 1.361 | 1.814 | 2.268 | 2.722 | 3.175 | 3.629 | 4.082 |
| 10 | 4.536 | 4.990 | 5.443 | 5.897 | 6.350 | 6.804 | 7.257 | 7.711 | 8.165 | 8.618 |
| 20 | 9.072 | 9.525 | 9.979 | 10.433 | 10.886 | 11.340 | 11.793 | 12.247 | 12.701 | 13.154 |
| 30 | 13.608 | 14.061 | 14.515 | 14.969 | 15.422 | 15.876 | 16.329 | 16.783 | 17.237 | 17.690 |
| 40 | 18.144 | 18.597 | 19.051 | 19.504 | 19.958 | 20.412 | 20.865 | 21.319 | 21.772 | 22.226 |
| 50 | 22.680 | 23.133 | 23.587 | 24.040 | 24.494 | 24.948 | 25.401 | 25.855 | 26.309 | 26.762 |
| 60 | 27.216 | 27.669 | 28.123 | 28.576 | 29.030 | 29.484 | 29.937 | 30.391 | 30.844 | 31.298 |
| 70 | 31.752 | 32.205 | 32.659 | 33.112 | 33.566 | 34.019 | 34.473 | 34.927 | 35.380 | 35.834 |
| 80 | 36.288 | 36.741 | 37.195 | 37.648 | 38.102 | 38.555 | 39.009 | 39.463 | 39.916 | 40.370 |
| 90 | 40.823 | 41.277 | 41.731 | 42.184 | 42.638 | 43.091 | 43.545 | 43.999 | 44.452 | 44.906 |
| 100 | 45.359 | 45.813 | 46.266 | 46.720 | 47.174 | 47.627 | 48.081 | 48.534 | 48.988 | 49.442 |

Figure 1-2. Weight Conversions (Sheet 1 of 2)

(Kilograms \times 2.205 = Pounds) - (Pounds \times .454 = Kilograms)

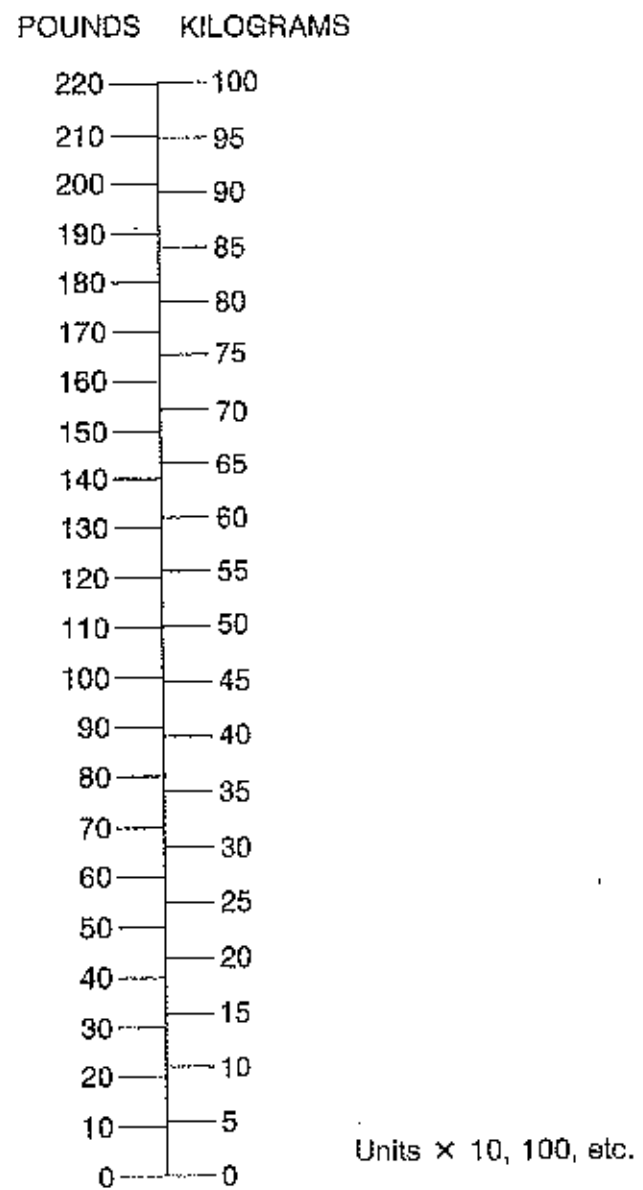

0585T1027

Figure 1-2 . Weight Conversions (Sheet 2 of 2)

SECTION 1
GENERAL

CESSNA
MODEL 172R

(Meters × 3.281 = Feet) (Feet × .305 = Meters)

METERS INTO FEET
MÈTRES EN PIEDS

| m | 0 | 1 | 2 | 3 | 4 | 5 | 6 | 7 | 8 | 9 |
|-----|--------|--------|--------|--------|--------|--------|--------|--------|--------|--------|
| | feet | feet | feet | feet | feet | feet | feet | feet | feet | feet |
| 0 | --- | 3.281 | 6.562 | 9.842 | 13.123 | 16.404 | 19.685 | 22.966 | 26.247 | 29.528 |
| 10 | 32.808 | 36.089 | 39.370 | 42.651 | 45.932 | 49.212 | 52.493 | 55.774 | 59.056 | 62.336 |
| 20 | 65.617 | 68.897 | 72.178 | 75.459 | 78.740 | 82.021 | 85.302 | 88.582 | 91.863 | 95.144 |
| 30 | 98.426 | 101.71 | 104.99 | 108.27 | 111.55 | 114.83 | 118.11 | 121.39 | 124.67 | 127.95 |
| 40 | 131.23 | 134.51 | 137.79 | 141.08 | 144.36 | 147.64 | 150.92 | 154.20 | 157.48 | 160.76 |
| 50 | 164.04 | 167.32 | 170.60 | 173.88 | 177.16 | 180.45 | 183.73 | 187.01 | 190.29 | 193.57 |
| 60 | 195.85 | 200.13 | 203.41 | 206.69 | 209.97 | 213.25 | 216.53 | 219.82 | 223.10 | 226.38 |
| 70 | 229.66 | 232.94 | 236.22 | 239.50 | 242.78 | 246.06 | 249.34 | 252.62 | 255.90 | 259.18 |
| 80 | 262.47 | 265.75 | 269.03 | 272.31 | 275.59 | 278.87 | 282.15 | 285.43 | 288.71 | 291.99 |
| 90 | 295.27 | 298.55 | 301.84 | 305.12 | 308.40 | 311.68 | 314.96 | 318.24 | 321.52 | 324.80 |
| 100 | 328.09 | 331.36 | 334.64 | 337.93 | 341.21 | 344.49 | 347.77 | 351.05 | 354.33 | 357.61 |

FEET INTO METERS
PIEDS EN MÈTRES

| ft | 0 | 1 | 2 | 3 | 4 | 5 | 6 | 7 | 8 | 9 |
|-----|--------|--------|--------|--------|--------|--------|--------|--------|--------|--------|
| | m | m | m | m | m | m | m | m | m | m |
| 0 | --- | 0.305 | 0.610 | 0.914 | 1.219 | 1.524 | 1.829 | 2.134 | 2.438 | 2.743 |
| 10 | 3.048 | 3.353 | 3.658 | 3.962 | 4.267 | 4.572 | 4.877 | 5.182 | 5.486 | 5.791 |
| 20 | 6.096 | 6.401 | 6.706 | 7.010 | 7.315 | 7.620 | 7.925 | 8.230 | 8.534 | 8.839 |
| 30 | 9.144 | 9.449 | 9.754 | 10.058 | 10.363 | 10.668 | 10.973 | 11.278 | 11.582 | 11.887 |
| 40 | 12.192 | 12.497 | 12.802 | 13.106 | 13.411 | 13.716 | 14.021 | 14.326 | 14.630 | 14.935 |
| 50 | 15.240 | 15.545 | 15.850 | 16.154 | 16.459 | 16.764 | 17.069 | 17.374 | 17.678 | 17.983 |
| 60 | 18.288 | 18.593 | 18.898 | 19.202 | 19.507 | 19.812 | 20.117 | 20.422 | 20.726 | 21.031 |
| 70 | 21.336 | 21.641 | 21.946 | 22.250 | 22.555 | 22.860 | 23.165 | 23.470 | 23.774 | 24.079 |
| 80 | 24.384 | 24.689 | 24.994 | 25.298 | 25.603 | 25.908 | 26.213 | 26.518 | 26.822 | 27.127 |
| 90 | 27.432 | 27.737 | 28.042 | 28.346 | 28.651 | 28.956 | 29.261 | 29.566 | 29.870 | 30.175 |
| 100 | 30.480 | 30.785 | 31.090 | 31.394 | 31.699 | 32.004 | 32.309 | 32.614 | 32.918 | 33.223 |

Figure 1-3. Length Conversions (Sheet 1 of 2)

(Meters x 3.281 = Feet)

(Feet x .305 = Meters)

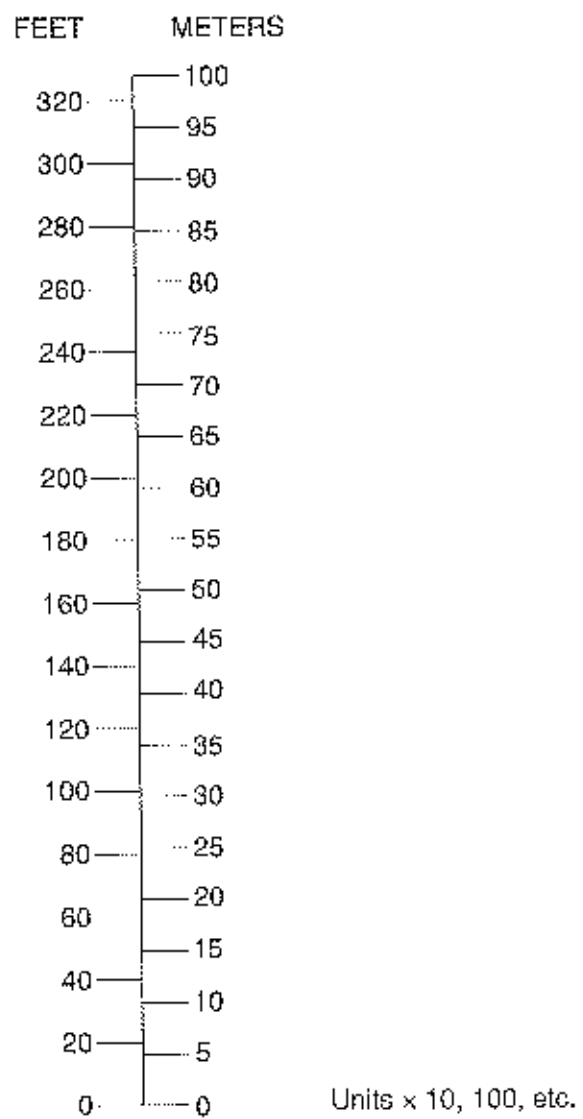



Figure 1-3 . Length Conversions (Sheet 2)

SECTION 1
GENERAL

CESSNA
MODEL 172R

(Centimeters \times .394 = Inches) (Inches \times 2.54 = Centimeters)

CENTIMETERS INTO INCHES 
CENTIMETRES EN POUCHES

| cm | 0 | 1 | 2 | 3 | 4 | 5 | 6 | 7 | 8 | 9 |
|-----|--------|--------|--------|--------|--------|--------|--------|--------|--------|--------|
| | in. | in. | in. | in. | in. | in. | in. | in. | in. | in. |
| 0 | --- | 0.394 | 0.787 | 1.181 | 1.575 | 1.969 | 2.362 | 2.756 | 3.150 | 3.543 |
| 10 | 3.937 | 4.331 | 4.724 | 5.118 | 5.512 | 5.906 | 6.299 | 6.693 | 7.087 | 7.480 |
| 20 | 7.874 | 8.268 | 8.661 | 9.055 | 9.449 | 9.843 | 10.236 | 10.630 | 11.024 | 11.417 |
| 30 | 11.811 | 12.205 | 12.598 | 12.992 | 13.386 | 13.780 | 14.173 | 14.567 | 14.961 | 15.354 |
| 40 | 15.748 | 16.142 | 16.535 | 16.929 | 17.323 | 17.717 | 18.110 | 18.504 | 18.898 | 19.291 |
| 50 | 19.685 | 20.079 | 20.472 | 20.866 | 21.260 | 21.654 | 22.047 | 22.441 | 22.835 | 23.228 |
| 60 | 23.622 | 24.016 | 24.409 | 24.803 | 25.197 | 25.591 | 25.984 | 26.378 | 26.772 | 27.164 |
| 70 | 27.559 | 27.953 | 28.346 | 28.740 | 29.134 | 29.528 | 29.921 | 30.315 | 30.709 | 31.102 |
| 80 | 31.496 | 31.890 | 32.283 | 32.677 | 33.071 | 33.465 | 33.858 | 34.252 | 34.646 | 35.039 |
| 90 | 35.433 | 35.827 | 36.220 | 36.614 | 37.008 | 37.402 | 37.795 | 38.189 | 38.583 | 38.976 |
| 100 | 39.370 | 39.764 | 40.157 | 40.551 | 40.945 | 41.339 | 41.732 | 42.126 | 42.520 | 42.913 |

INCHES INTO CENTIMETERS 
POUCHES EN CENTIMETRES

| in. | 0 | 1 | 2 | 3 | 4 | 5 | 6 | 7 | 8 | 9 |
|-----|--------|--------|--------|--------|--------|--------|--------|--------|--------|--------|
| | cm | cm | cm | cm | cm | cm | cm | cm | cm | cm |
| 0 | --- | 2.54 | 5.08 | 7.62 | 10.16 | 12.70 | 15.24 | 17.78 | 20.32 | 22.86 |
| 10 | 25.40 | 27.94 | 30.48 | 33.02 | 35.56 | 38.10 | 40.64 | 43.18 | 45.72 | 48.26 |
| 20 | 50.80 | 53.34 | 55.88 | 58.42 | 60.96 | 63.50 | 66.04 | 68.58 | 71.12 | 73.66 |
| 30 | 76.20 | 78.74 | 81.28 | 83.82 | 86.36 | 88.90 | 91.44 | 93.98 | 96.52 | 99.06 |
| 40 | 101.60 | 104.14 | 106.68 | 109.22 | 111.76 | 114.30 | 116.84 | 119.38 | 121.92 | 124.46 |
| 50 | 127.00 | 129.54 | 132.08 | 134.62 | 137.16 | 139.70 | 142.24 | 144.78 | 147.32 | 149.86 |
| 60 | 152.40 | 154.94 | 157.48 | 160.02 | 162.56 | 165.10 | 167.64 | 170.18 | 172.72 | 175.26 |
| 70 | 177.80 | 180.34 | 182.88 | 185.42 | 187.96 | 190.50 | 193.04 | 195.58 | 198.12 | 200.66 |
| 80 | 203.20 | 205.74 | 208.28 | 210.82 | 213.36 | 215.90 | 218.44 | 220.98 | 223.52 | 226.06 |
| 90 | 228.80 | 231.34 | 233.88 | 236.42 | 238.96 | 241.50 | 244.04 | 246.58 | 249.12 | 251.66 |
| 100 | 254.00 | 256.54 | 259.08 | 261.62 | 264.16 | 266.70 | 269.24 | 271.78 | 274.32 | 276.86 |

Figure 1-4. Length Conversions (Sheet 1 of 2)

(Centimeters \times .394 = Inches) (Inches \times 2.54 = Centimeters) ■

INCHES CENTIMETERS

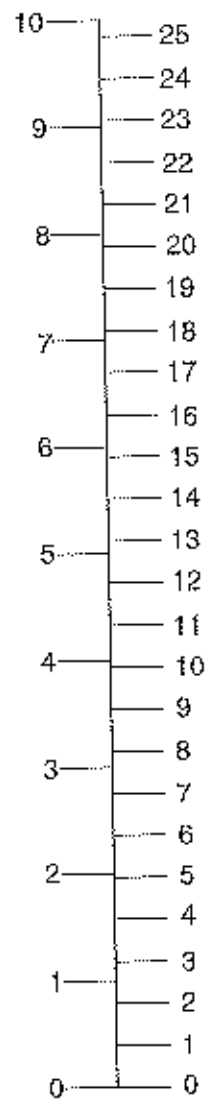

Units \times 10, 100, etc.

058511028

Figure 1-4. Length Conversions (Sheet 2) ■

SECTION 1
GENERAL

CESSNA
MODEL 172R

(Statute Miles \times 1.609 = Kilometers) (Kilometers \times .622 = Statute Miles)
 (Statute Miles \times .869 = Nautical Miles) (Nautical Miles \times 1.15 = Statute Miles)
 (Nautical Miles \times 1.852 = Kilometers) (Kilometers \times .54 = Nautical Miles)

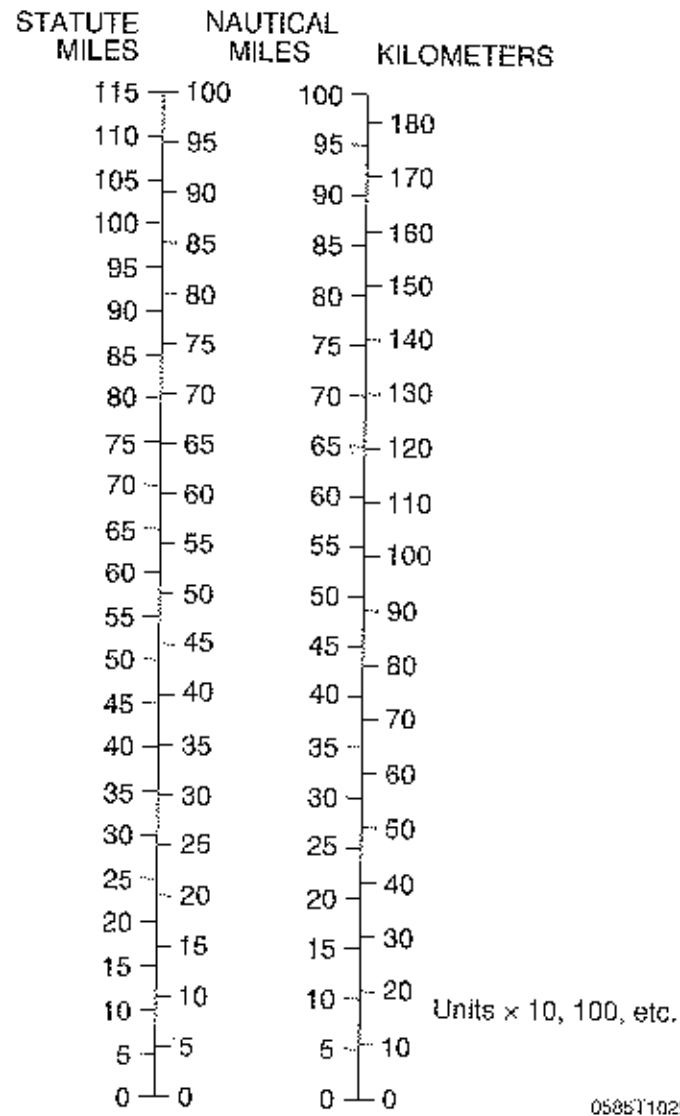

058511029

Figure 1-5. Distance Conversions

(Imperial Gallons × 4.546 = Liters) (Liters × .22 = Imperial Gallons)

LITERS INTO IMPERIAL GALLONS
LITRES EN GALLONS IMPERIAL

| Lt | 0 | 1 | 2 | 3 | 4 | 5 | 6 | 7 | 8 | 9 |
|-----|--------|--------|--------|--------|--------|--------|--------|--------|--------|--------|
| | IG | IG | IG | IG | IG | IG | IG | IG | IG | IG |
| 0 | --- | 0.220 | 0.440 | 0.660 | 0.880 | 1.100 | 1.320 | 1.540 | 1.760 | 1.980 |
| 10 | 2.200 | 2.420 | 2.640 | 2.860 | 3.080 | 3.300 | 3.520 | 3.740 | 3.960 | 4.180 |
| 20 | 4.400 | 4.620 | 4.840 | 5.059 | 5.279 | 5.499 | 5.719 | 5.939 | 6.159 | 6.379 |
| 30 | 6.599 | 6.819 | 7.039 | 7.259 | 7.479 | 7.699 | 7.919 | 8.139 | 8.359 | 8.579 |
| 40 | 8.799 | 9.019 | 9.239 | 9.459 | 9.679 | 9.899 | 10.119 | 10.339 | 10.559 | 10.779 |
| 50 | 10.999 | 11.219 | 11.439 | 11.659 | 11.879 | 12.099 | 12.319 | 12.539 | 12.759 | 12.979 |
| 60 | 13.199 | 13.419 | 13.639 | 13.859 | 14.078 | 14.298 | 14.518 | 14.738 | 14.958 | 15.178 |
| 70 | 15.398 | 15.618 | 15.838 | 16.058 | 16.278 | 16.498 | 16.718 | 16.938 | 17.158 | 17.378 |
| 80 | 17.598 | 17.818 | 18.038 | 18.258 | 18.478 | 18.698 | 18.918 | 19.138 | 19.358 | 19.578 |
| 90 | 19.798 | 20.018 | 20.238 | 20.458 | 20.678 | 20.898 | 21.118 | 21.338 | 21.558 | 21.778 |
| 100 | 21.998 | 22.218 | 22.438 | 22.658 | 22.878 | 23.098 | 23.318 | 23.537 | 23.757 | 23.977 |

IMPERIAL GALLONS INTO LITERS
GALLONS IMPERIAL EN LITRES

| IG | 0 | 1 | 2 | 3 | 4 | 5 | 6 | 7 | 8 | 9 |
|-----|--------|--------|--------|--------|--------|--------|--------|--------|--------|--------|
| | Lt | Lt | Lt | Lt | Lt | Lt | Lt | Lt | Lt | Lt |
| 0 | --- | 4.546 | 9.092 | 13.639 | 18.184 | 22.730 | 27.276 | 31.822 | 36.368 | 40.914 |
| 10 | 45.460 | 50.006 | 54.552 | 59.097 | 63.643 | 68.189 | 72.735 | 77.281 | 81.827 | 86.373 |
| 20 | 90.919 | 95.466 | 100.01 | 104.56 | 109.10 | 113.65 | 118.20 | 122.74 | 127.29 | 131.83 |
| 30 | 136.38 | 140.93 | 145.47 | 150.02 | 154.56 | 159.11 | 163.66 | 168.20 | 172.75 | 177.29 |
| 40 | 181.84 | 186.38 | 190.93 | 195.48 | 200.02 | 204.57 | 209.11 | 213.66 | 218.21 | 222.75 |
| 50 | 227.30 | 231.84 | 236.39 | 240.94 | 245.48 | 250.03 | 254.57 | 259.12 | 263.67 | 268.21 |
| 60 | 272.76 | 277.30 | 281.85 | 286.40 | 290.94 | 295.49 | 300.03 | 304.58 | 309.13 | 313.67 |
| 70 | 318.22 | 322.76 | 327.31 | 331.86 | 336.40 | 340.95 | 345.49 | 350.04 | 354.59 | 359.13 |
| 80 | 363.66 | 368.22 | 372.77 | 377.32 | 381.86 | 386.41 | 390.95 | 395.50 | 400.04 | 404.59 |
| 90 | 409.14 | 413.68 | 418.23 | 422.77 | 427.32 | 431.87 | 436.41 | 440.96 | 445.50 | 450.05 |
| 100 | 454.60 | 459.14 | 463.69 | 468.23 | 472.78 | 477.33 | 481.87 | 486.42 | 490.96 | 495.51 |

Figure 1-6. Volume Conversions (Sheet 1 of 3)

(Imperial Gallons \times 4.4546 = Liters)
(Liters \times .22 = Imperial Gallons)

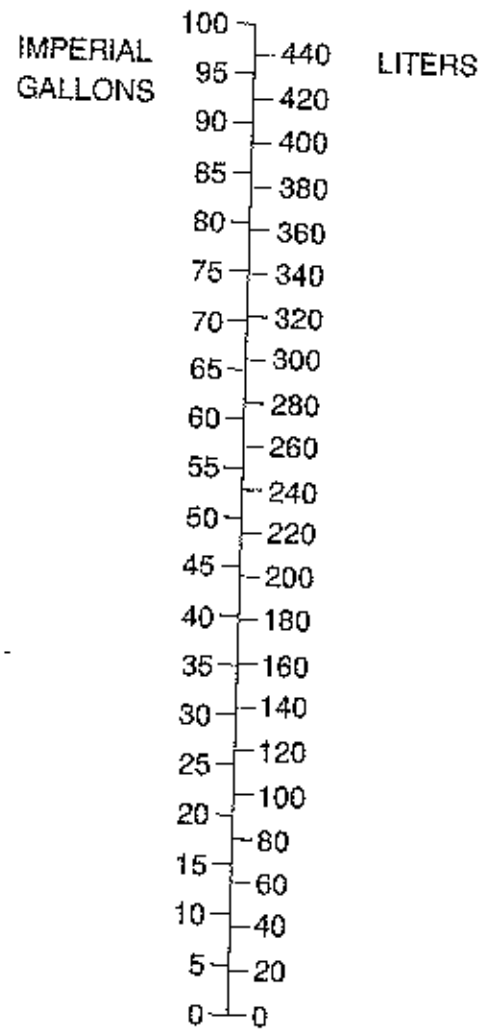

Units \times 10, 100, etc.

0585T1032

Figure 1-6. Volume Conversions (Sheet 2 of 3).

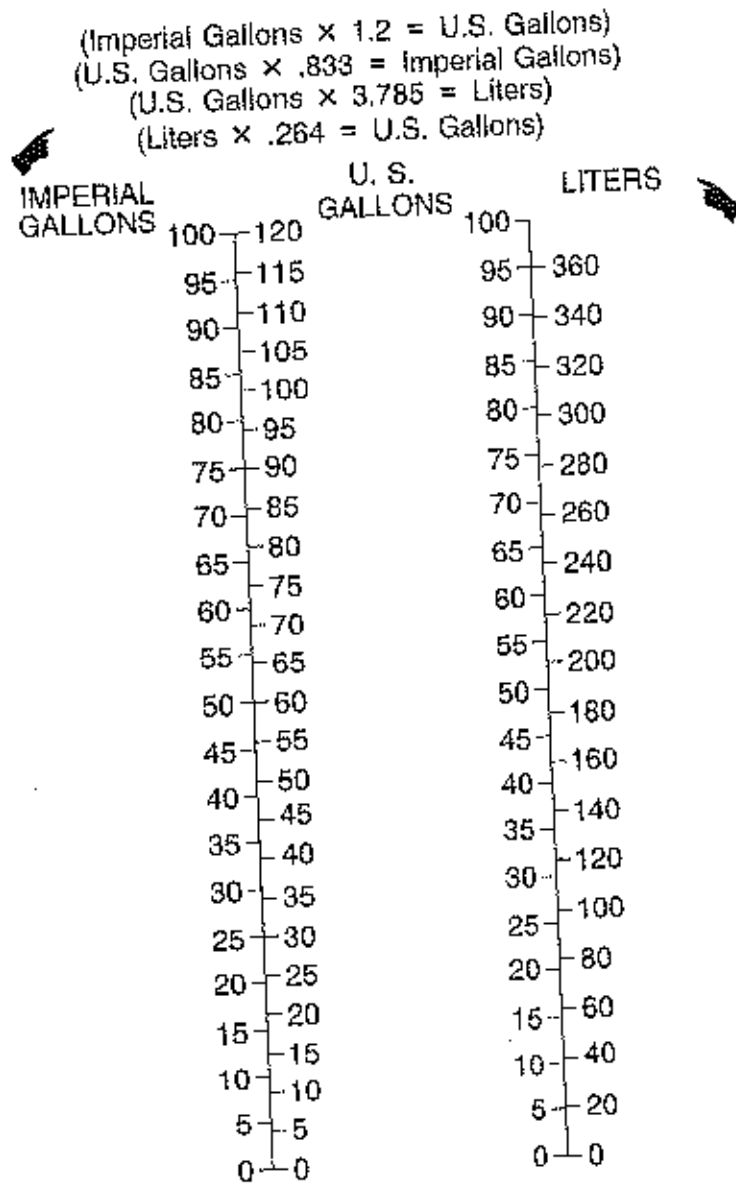

Units \times 10, 100, etc.

0585T1033

Figure 1-6. Volume Conversions (Sheet 3 of 3)

TEMPERATURE CONVERSIONS

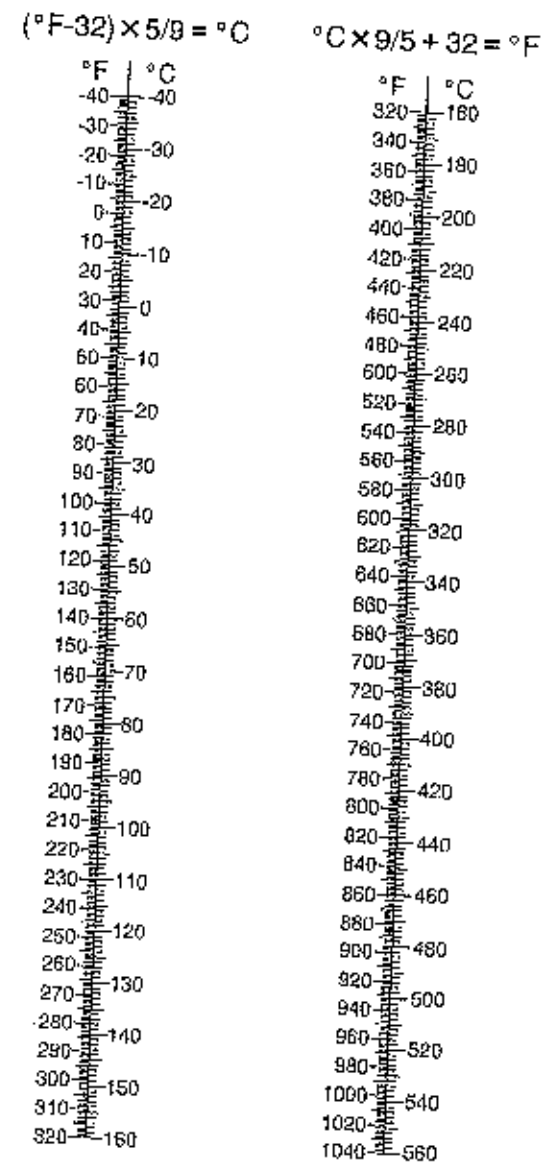

Figure 1-7. Temperature Conversions

0586T1034

PRESSURE CONVERSION
HECTOPASCALS (MILLIBARS) TO INCHES MERCURY (inHG)

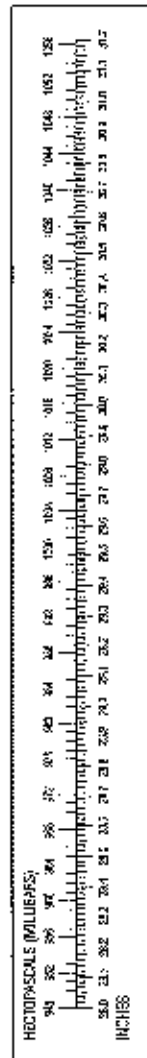
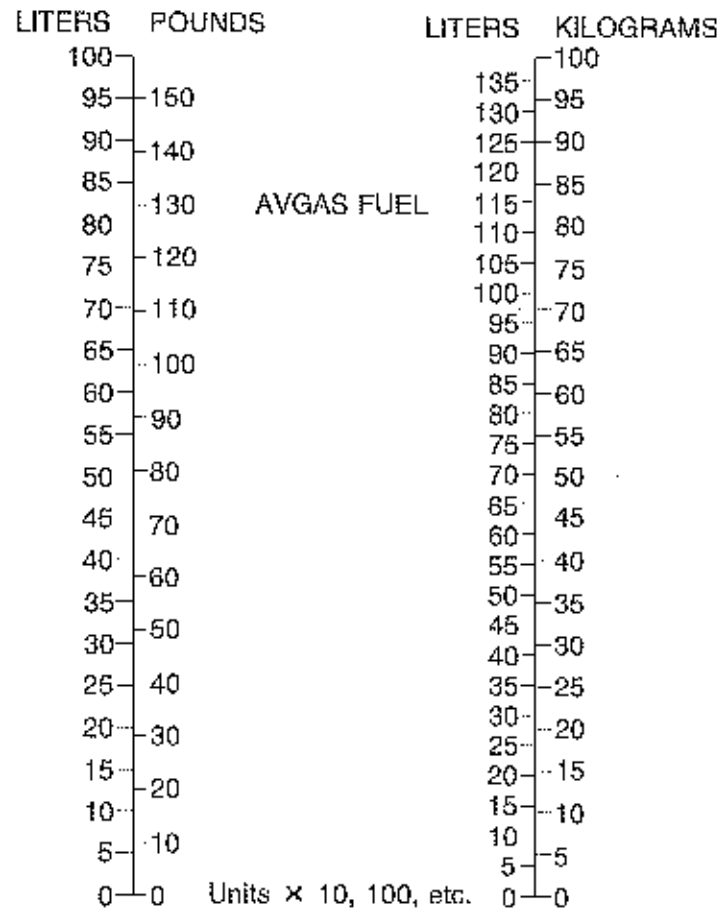

Figure 1-8. Hectopascals to Inches Mercury

AVGAS Specific Gravity = .72
 (Liters X .72 = Kilograms) (Kilograms X 1.389 = Liters)
 (Liters X 1.58 = Pounds) (Pounds X .633 = Liters)



0505T1030

Figure 1-9. Volume to Weight Conversion

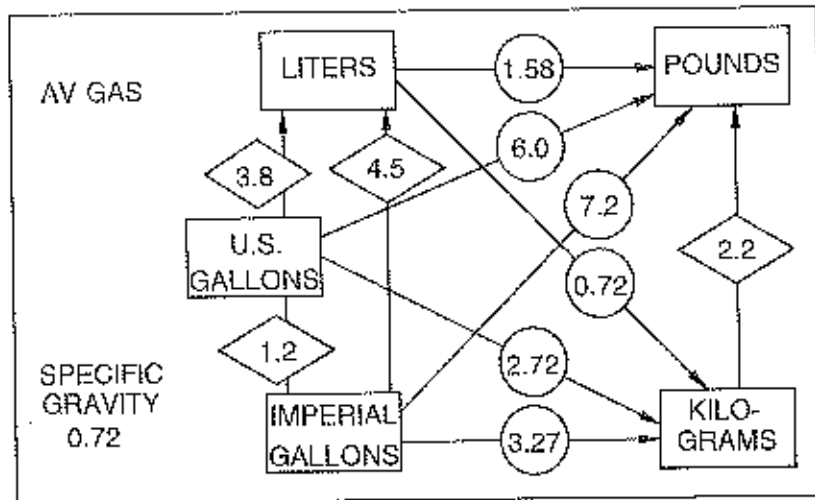

Figure 1-10. Quick Conversions

1

2

3

4

5

6

7

8

9

10

11

12

13

14

15

16

17

18

19

20

SECTION 2 LIMITATIONS

TABLE OF CONTENTS

Page

| | |
|--------------------------------------|------|
| Introduction | 2-3 |
| Airspeed Limitations | 2-4 |
| Airspeed Indicator Markings | 2-5 |
| Powerplant Limitations | 2-5 |
| Powerplant Instrument Markings | 2-6 |
| Weight Limits | 2-7 |
| Normal Category | 2-7 |
| Utility Category | 2-7 |
| Center Of Gravity Limits | 2-7 |
| Normal Category | 2-7 |
| Utility Category | 2-8 |
| Maneuver Limits | 2-8 |
| Normal Category | 2-8 |
| Utility Category | 2-9 |
| Flight Load Factor Limits | 2-10 |
| Normal Category | 2-10 |
| Utility Category | 2-10 |
| Kinds Of Operation Limits | 2-10 |
| Fuel Limitations | 2-11 |
| Additional Fuel Limitations | 2-11 |
| Other Limitations | 2-11 |
| Flap Limitations | 2-11 |
| Placards | 2-12 |

INTRODUCTION

Section 2 includes operating limitations, instrument markings, and basic placards necessary for the safe operation of the airplane, its engine, standard systems and standard equipment. The limitations included in this section and in Section 9 have been approved by the Federal Aviation Administration. Observance of these operating limitations is required by Federal Aviation Regulations.

NOTE

Refer to the Supplements, Section 9, of this Pilot's Operating Handbook for amended operating limitations, operating procedures, performance data and other necessary information for airplanes equipped with specific options.

NOTE

The airspeeds listed in the Airspeed Limitations chart (Figure 2-1) and the Airspeed Indicator Markings chart (Figure 2-2) are based on Airspeed Calibration data shown in Section 5 with the normal static source. If the alternate static source is being used, ample margins should be observed to allow for the airspeed calibration variations between the normal and alternate static sources as shown in Section 5.

The Cessna Model No. 172R is certificated under FAA Type Certificate No. 3A12.

AIRSPEED LIMITATIONS

Airspeed limitations and their operational significance are shown in Figure 2-1. Maneuvering speeds shown apply to normal category operations. The utility category maneuvering speed is 92 KIAS at 2100 pounds.

| SYMBOL | SPEED | KCAS | KIAS | REMARKS |
|-----------------|---|----------------|----------------|--|
| V _{NE} | Never Exceed Speed | 160 | 163 | Do not exceed this speed in any operation. |
| V _{NO} | Maximum Structural Cruising Speed | 126 | 129 | Do not exceed this speed except in smooth air, and then only with caution. |
| V _A | Maneuvering Speed: 2450 Pounds 2000 Pounds 1600 Pounds | 97 91 82 | 99 92 82 | Do not make full or abrupt control movements above this speed. |
| V _{FE} | Maximum Flap Extended Speed: 10° Flaps 10° to 30° Flaps | 108 84 | 110 85 | Do not exceed this speed with flaps down. |
| ---- | Maximum Window Open Speed | 160 | 163 | Do not exceed this speed with windows open. |

Figure 2-1. Airspeed Limitations

AIRSPPEED INDICATOR MARKINGS

Airspeed indicator markings and their color code significance are shown in Figure 2-2.

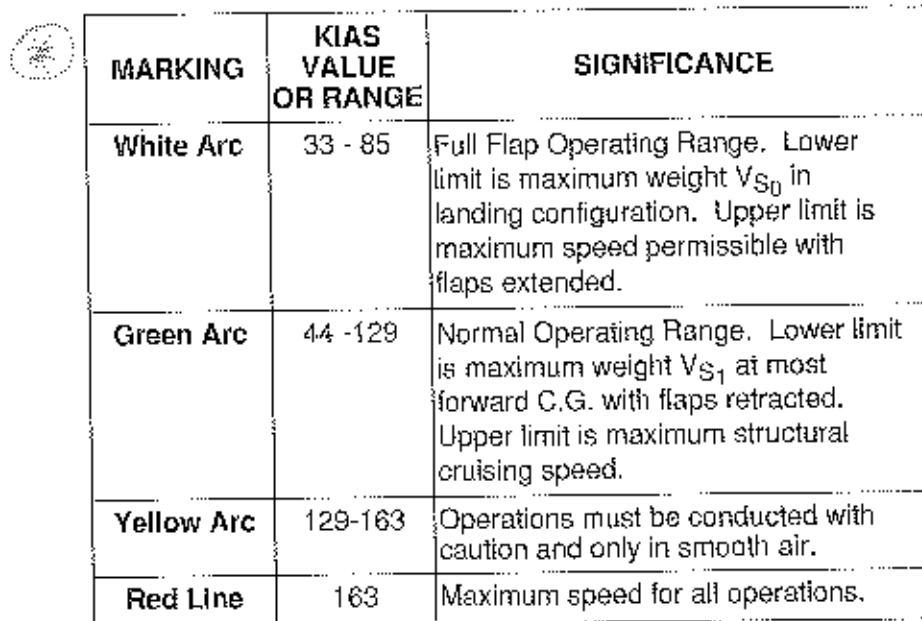

| MARKING | KIAS VALUE OR RANGE | SIGNIFICANCE |
|------------|---------------------|---|
| White Arc | 33 - 85 | Full Flap Operating Range. Lower limit is maximum weight V_{S0} in landing configuration. Upper limit is maximum speed permissible with flaps extended. |
| Green Arc | 44 - 129 | Normal Operating Range. Lower limit is maximum weight V_{S1} at most forward C.G. with flaps retracted. Upper limit is maximum structural cruising speed. |
| Yellow Arc | 129-163 | Operations must be conducted with caution and only in smooth air. |
| Red Line | 163 | Maximum speed for all operations. |

Figure 2-2. Airspeed Indicator Markings

POWERPLANT LIMITATIONS

Engine Manufacturer: Textron Lycoming.
 Engine Model Number: IO-360-L2A.
 Maximum Power: 160 BHP rating.
 Engine Operating Limits for Takeoff and Continuous Operations:
 Maximum Engine Speed: 2400 RPM.

NOTE

The static RPM range at full throttle is 2065 - 2165 RPM.

Maximum Oil Temperature: 245°F (118°C).
 Oil Pressure, Minimum: 20 PSI.
 Maximum: 115 PSI.

SECTION 2
LIMITATIONS

CESSNA
MODEL 172R

Fuel Grade: See Fuel Limitations.

Oil Grade (Specification):

MIL-L-6082 or SAE J1966 Aviation Grade Straight Mineral Oil or MIL-L-22851 or SAE J1899 Ashless Dispersant Oil. Oil must comply with the latest revision and/or supplement for Textron Lycoming Service Instruction No. 1014.

Propeller Manufacturer: McCauley Propeller Systems.

Propeller Model Number: 1C235/LFA7570.

Propeller Diameter: 75 inches.

74 inch minimum.

POWERPLANT INSTRUMENT MARKINGS



Powerplant instrument markings and their color code significance are shown in Figure 2-3.

See
500

| INSTRUMENT | RED LINE (MINIMUM) | GREEN ARC (NORMAL OPERATING) | RED LINE (MAX) |
|--------------------|---------------------------------------|------------------------------------|----------------------|
| Tachometer: | ---- | 1900 to 2400 RPM | 2400 RPM |
| Oil Temperature | ---- | 100 to 245°F | 245°F |
| Oil Pressure | 20 PSI | 50 to 90 PSI | 115 PSI |
| Fuel Quantity | 0 (1.5 Gal. Unusable Each Tank) | ---- | ---- |
| Fuel Flow | ---- | 0 to 11 GPH | ---- |
| Vacuum Gage | ---- | 4.5 - 5.5 in.Hg | ---- |

Figure 2-3. Powerplant Instrument Markings

CESSNA
MODEL 172R

SECTION 2
LIMITATIONS



WEIGHT LIMITS

NORMAL CATEGORY

Maximum Ramp Weight: 2457 lbs.
Maximum Takeoff Weight: 2450 lbs.
Maximum Landing Weight: 2450 lbs.
Maximum Weight in Baggage Compartment:
Baggage Area 1 - Station 82 to 108: 120 lbs.
Baggage Area 2 - Station 108 to 142: 50 lbs.

NOTE

The maximum combined weight capacity for baggage areas 1 and 2 is 120 lbs.

UTILITY CATEGORY

Maximum Ramp Weight: 2107 lbs.
Maximum Takeoff Weight: 2100 lbs.
Maximum Landing Weight: 2100 lbs.
Maximum Weight in Baggage Compartment: In the utility category, the baggage compartment and rear seat must not be occupied.

CENTER OF GRAVITY LIMITS

NORMAL CATEGORY

Center of Gravity Range:

Forward: 35.0 inches aft of datum at 1950 lbs. or less, with straight line variation to 40.0 inches aft of datum at 2450 lbs.

Aft: 47.3 inches aft of datum at all weights.

Reference Datum: Lower portion of front face of firewall.

SECTION 2
LIMITATIONS

CESSNA
MODEL 172R

UTILITY CATEGORY

Center of Gravity Range:

Forward: 35.0 inches aft of datum at 1950 lbs. or less, with straight line variation to 36.5 inches aft of datum at 2100 lbs.

Aft: 40.5 inches aft of datum at all weights.

Reference Datum: Lower portion of front face of firewall.

MANEUVER LIMITS

NORMAL CATEGORY

This airplane is certificated in both the normal and utility category. The normal category is applicable to aircraft intended for non aerobatic operations. These include any maneuvers incidental to normal flying, stalls (except whip stalls), lazy eights, chandelles, and turns in which the angle of bank is not more than 60°.

NORMAL CATEGORY MANEUVERS AND RECOMMENDED ENTRY SPEED*

| | |
|-----------------------------------|-------------------|
| Chandelles | 105 Knots |
| Lazy Eights | 105 Knots |
| Steep Turns | 95 Knots |
| Stalls (Except Whip Stalls) | Slow Deceleration |

* Abrupt use of the controls is prohibited above 99 knots.

105 kts

UTILITY CATEGORY

This airplane is not designed for purely aerobatic flight. However, in the acquisition of various certificates such as commercial pilot and flight instructor, certain maneuvers are required by the FAA. All of these maneuvers are permitted in this airplane when operated in the utility category.

In the utility category, the rear seat must not be occupied and the baggage compartment must be empty.

UTILITY CATEGORY MANEUVERS AND RECOMMENDED ENTRY SPEED*

| | |
|-----------------------------------|-------------------|
| Chandelles | 105 Knots |
| Lazy Eights | 105 Knots |
| Steep Turns | 95 Knots |
| Spins | Slow Deceleration |
| Stalls (Except Whip Stalls) | Slow Deceleration |

* Abrupt use of the controls is prohibited above 92 knots.

Aerobatics that may impose high loads should not be attempted. The important thing to bear in mind in flight maneuvers is that the airplane is clean in aerodynamic design and will build up speed quickly with the nose down. Proper speed control is an essential requirement for execution of any maneuver, and care should always be exercised to avoid excessive speed which in turn can impose excessive loads. In the execution of all maneuvers, avoid abrupt use of controls.

FLIGHT LOAD FACTOR LIMITS

NORMAL CATEGORY

Flight Load Factors (Maximum Takeoff Weight - 2450 lbs.):

| | |
|-------------------|---------------|
| *Flaps Up | +3.8g, -1.52g |
| *Flaps Down | +3.0g |

*The design load factors are 150% of the above, and in all cases, the structure meets or exceeds design loads.

UTILITY CATEGORY

Flight Load Factors (Maximum Takeoff Weight - 2100 lbs.):

| | |
|-------------------|---------------|
| *Flaps Up | +4.4g, -1.76g |
| *Flaps Down | +3.0g |

*The design load factors are 150% of the above, and in all cases, the structure meets or exceeds design loads.

KINDS OF OPERATION LIMITS

The airplane as delivered is equipped for day VFR and may be equipped for night VFR and/or IFR operations. FAR Part 91 establishes the minimum required instrumentation and equipment for these operations. The reference to types of flight operations on the operating limitations placard reflects equipment installed at the time of Airworthiness Certificate issuance.

Flight into known icing conditions is prohibited.

FUEL LIMITATIONS

Total Fuel: 56 U.S. gallons (2 tanks at 28.0 gallons each).

Usable Fuel (all flight conditions): 53.0 U.S. gallons.

Unusable Fuel: 3.0 U.S. gallons (1.5 gallons each tank).

NOTE

To ensure maximum fuel capacity and minimize cross-feeding when refueling, always park the airplane in a wings-level, normal ground attitude and place the fuel selector in the Left or Right position. Refer to Figure 1-1 for normal ground attitude definition.

ADDITIONAL FUEL LIMITATIONS

Takeoff and land with the fuel selector valve handle in the BOTH position.

Maximum slip or skid duration with one tank dry: 30 seconds.

Operation on either LEFT or RIGHT tank limited to level flight only.

With 1/4 tank or less, prolonged uncoordinated flight is prohibited when operating on either left or right tank.

Fuel remaining in the tank after the fuel quantity indicator reads 0 (red line) cannot be safely used in flight.

Approved Fuel Grades (and Colors):

- 100LL Grade Aviation Fuel (Blue).
- 100 Grade Aviation Fuel (Green).

OTHER LIMITATIONS

FLAP LIMITATIONS

Approved Takeoff Range: 0° to 10°
Approved Landing Range: 0° to 30°

PLACARDS

The following information must be displayed in the form of composite or individual placards.

1. In full view of the pilot: (The "DAY-NIGHT-VFR-IFR" entry, shown on the example below, will vary as the airplane is equipped).

The markings and placards installed in this airplane contain operating limitations which must be complied with when operating this airplane in the Normal Category. Other operating limitations which must be complied with when operating this airplane in this category or in the Utility Category are contained in the Pilot's Operating Handbook and FAA Approved Airplane Flight Manual.

Normal Category No acrobatic maneuvers, including spins, approved.

Utility Category No acrobatic maneuvers approved, except those listed in the Pilot's Operating Handbook.

Baggage compartment and rear seat must not be occupied.

Spin Recovery Opposite rudder - forward elevator - neutralize controls.

Flight into known icing conditions prohibited.

This airplane is certified for the following flight operations as of date of original airworthiness certificate:

DAY-NIGHT-VFR-IFR

2. On the fuel selector valve:

| | | |
|--|-------------------|---|
| TAKEOFF LANDING | BOTH 53.0 GAL. | ALL FLIGHT ATTITUDES |
| FUEL SELECTOR | | |
| LEFT 26.5 GAL. LEVEL FLIGHT ONLY | | RIGHT 26.5 GAL. LEVEL FLIGHT ONLY |

3. Near fuel tank filler cap:

| |
|---|
| FUEL 100LL/ 100 MIN. GRADE AVIATION GASOLINE CAP. 26.5 U.S. GAL. USABLE CAP 17.5 U.S. GAL. USABLE TO BOTTOM OF FILLER INDICATOR TAB |
|---|

4. On flap control indicator:

| | | |
|------------|----------|--|
| 0° to 10° | 110 KIAS | (Partial flap range with blue color code; also, mechanical detent at 10°.) |
| 10° to 30° | 85 KIAS | (White color code; also, mechanical detent at 20°.) |

SECTION 2
LIMITATIONS

CESSNA
MODEL 172R

5. In baggage compartment:

120 POUNDS MAXIMUM BAGGAGE
FORWARD OF BAGGAGE DOOR LATCH

50 POUNDS MAXIMUM
BAGGAGE AFT OF BAGGAGE DOOR LATCH

MAXIMUM 120 POUNDS COMBINED

FOR ADDITIONAL LOADING INSTRUCTIONS
SEE WEIGHT AND BALANCE DATA

6. A calibration card must be provided to indicate the accuracy of the magnetic compass in 30° increments.

7. On the oil filler cap:

OIL
8 QTS

8. On control lock:

CAUTION!
CONTROL LOCK
REMOVE BEFORE STARTING ENGINE

9. Near airspeed indicator:

MANEUVERING SPEED - 99 KIAS

10. On the Upper Right Side of the Aft Cabin Partition:

EMERGENCY LOCATOR TRANSMITTER
INSTALLED AFT OF THIS PARTITION
MUST BE SERVICED IN ACCORDANCE
WITH FAR PART 91.207

11. On forward face of firewall adjacent to the battery:

CAUTION 24 VOLTS D.C.
THIS AIRCRAFT IS EQUIPPED WITH ALTERNATOR
AND A NEGATIVE GROUND SYSTEM.
OBSERVE PROPER POLARITY
REVERSE POLARITY WILL DAMAGE ELECTRICAL
COMPONENTS.

12. On the upper right instrument panel:

SMOKING PROHIBITED

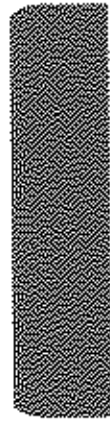

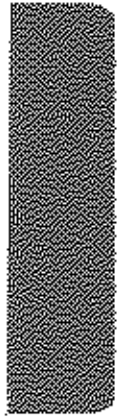

SECTION 3 EMERGENCY PROCEDURES

| TABLE OF CONTENTS | Page |
|---|------|
| Introduction | 3-3 |
| AIRSPEDS | |
| Airspeeds For Emergency Operation | 3-3 |
| EMERGENCY PROCEDURES CHECKLIST | |
| Engine Failures | 3-4 |
| Engine Failure During Takeoff Roll | 3-4 |
| Engine Failure Immediately After Takeoff | 3-4 |
| Engine Failure During Flight (Restart Procedures) | 3-4 |
| Forced Landings | 3-5 |
| Emergency Landing Without Engine Power | 3-5 |
| Precautionary Landing With Engine Power | 3-5 |
| Ditching | 3-5 |
| Fires | 3-7 |
| During Start On Ground | 3-7 |
| Engine Fire In Flight | 3-7 |
| Electrical Fire In Flight | 3-8 |
| Cabin Fire | 3-8 |
| Wing Fire | 3-8 |
| Icing | 3-9 |
| Inadvertent Icing Encounter | 3-9 |
| Static Source Blockage | 3-10 |
| Landing With A Flat Main Tire | 3-10 |
| Landing With A Flat Nose Tire | 3-10 |

TABLE OF CONTENTS (Continued)

| | Page |
|--|------|
| Electrical Power Supply System Malfunctions | 3-11 |
| Ammeter Shows Excessive Rate of Charge (Full Scale Deflection) | 3-11 |
| Low Voltage Annunciator (VOLTS) Illuminates During Flight (Ammeter Indicates Discharge) | 3-11 |
| Vacuum System Failure | 3-12 |

AMPLIFIED EMERGENCY PROCEDURES

| | |
|--|-----------|
| Engine Failure | 3-13 |
| Forced Landings | 3-15 |
| Landing Without Elevator Control | 3-15 |
| Fires | 3-16 |
| Emergency Operation In Clouds (Vacuum System Failure) .. | 3-16 |
| Executing A 180° Turn In Clouds | 3-16 |
| Emergency Descent Through Clouds | 3-17 |
| Recovery From Spiral Dive In The Clouds | 3-18 |
| Inadvertent Flight Into Icing Conditions | 3-18 |
| Static Source Blocked | 3-18 |
| Spins | 3-19 |
| Rough Engine Operation Or Loss Of Power | 3-20 |
| Spark Plug Fouling | 3-20 |
| Magneto Malfunction | 3-20 |
| Engine-Driven Fuel Pump Failure | 3-20 |
| Excessive Fuel Vapor Indications | 3-21 |
| Low Oil Pressure | 3-21 |
| Electrical Power Supply System Malfunctions | 3-22 |
| Excessive Rate of Charge | 3-22 |
| Insufficient Rate Of Charge | 3-23/3-24 |
| Other Emergencies | 3-23/3-24 |
| Windshield Damage | 3-23/3-24 |



INTRODUCTION

Section 3 provides checklist and amplified procedures for coping with emergencies that may occur. Emergencies caused by airplane or engine malfunctions are extremely rare if proper preflight inspections and maintenance are practiced. Enroute weather emergencies can be minimized or eliminated by careful flight planning and good judgment when unexpected weather is encountered. However, should an emergency arise, the basic guidelines described in this section should be considered and applied as necessary to correct the problem. Emergency procedures associated with standard avionics, the ELT, or any optional systems can be found in the Supplements, Section 9.

AIRSPEEDS

AIRSPEEDS FOR EMERGENCY OPERATION

| | |
|---|---------|
| Engine Failure After Takeoff: | |
| Wing Flaps Up | 65 KIAS |
| Wing Flaps Down | 60 KIAS |
| Maneuvering Speed: | |
| 2450 Lbs | 99 KIAS |
| 2100 Lbs | 92 KIAS |
| 1600 Lbs | 82 KIAS |
| Maximum Glide | 65 KIAS |
| Precautionary Landing With Engine Power | 60 KIAS |
| Landing Without Engine Power: | |
| Wing Flaps Up | 65 KIAS |
| Wing Flaps Down | 60 KIAS |

EMERGENCY PROCEDURES CHECKLIST

Procedures in the Emergency Procedures Checklist portion of this section shown in **bold faced** type are immediate action items which should be committed to memory.

ENGINE FAILURES

ENGINE FAILURE DURING TAKEOFF ROLL

1. **Throttle -- IDLE.**
2. **Brakes-- APPLY.**
3. Wing Flaps -- RETRACT.
4. Mixture -- IDLE CUT OFF.
5. Ignition Switch -- OFF.
6. Master Switch -- OFF.

ENGINE FAILURE IMMEDIATELY AFTER TAKEOFF

1. **Airspeed -- 65 KIAS (flaps UP),
60 KIAS (flaps DOWN).**
2. Mixture -- IDLE CUT OFF.
3. Fuel Shutoff Valve -- OFF (Pull Full Out).
4. Ignition Switch -- OFF.
5. Wing Flaps -- AS REQUIRED.
6. Master Switch -- OFF.
7. Cabin Door -- UNLATCH.
8. Land -- STRAIGHT AHEAD.

 **ENGINE FAILURE DURING FLIGHT (Restart Procedures)**

SEE
STC

1. Airspeed -- 65 KIAS.
2. Fuel Shutoff Valve -- ON (push full in).
3. Fuel Selector Valve -- BOTH.
4. Auxiliary Fuel Pump Switch -- ON.
5. Mixture -- RICH (if restart has not occurred).
6. Ignition Switch -- BOTH (or START if propeller is stopped).

NOTE

If the propeller is windmilling, the engine will restart automatically within a few seconds. If the propeller has stopped (possible at low speeds), turn the ignition switch to START, advance the throttle slowly from idle and lean the mixture from full rich as required for smooth operation.

7. Auxiliary Fuel Pump Switch -- OFF.

NOTE

If the fuel flow indicator immediately drops to zero (indicating an engine-driven fuel pump failure), return the Auxiliary Fuel Pump Switch to the ON position.

FORCED LANDINGS



EMERGENCY LANDING WITHOUT ENGINE POWER

SEE
STC

1. Passenger Seat Backs -- MOST UPRIGHT POSITION.
2. Seats and Seat Belts -- SECURE.
3. Airspeed -- 65 KIAS (flaps UP),
60 KIAS (flaps DOWN).
4. Mixture -- IDLE CUT OFF.
5. Fuel Shutoff Valve -- OFF (Pull Full Out).
6. Ignition Switch -- OFF.
7. Wing Flaps -- AS REQUIRED (30° recommended).
8. Master Switch -- OFF (when landing is assured).
9. Doors -- UNLATCH PRIOR TO TOUCHDOWN.
10. Touchdown -- SLIGHTLY TAIL LOW.
11. Brakes -- APPLY HEAVILY.

 **PRECAUTIONARY LANDING WITH ENGINE POWER**

1. Passenger Seat Backs -- MOST UPRIGHT POSITION.
2. Seats and Seat Belts -- SECURE.
3. Airspeed -- 60 KIAS.
4. Wing Flaps -- 20°.
5. Selected Field -- FLY OVER, noting terrain and obstructions, then retract flaps upon reaching a safe altitude and airspeed.
6. Avionics Master Switch and Electrical Switches -- OFF.
7. Wing Flaps -- 30° (on final approach).
8. Airspeed -- 60 KIAS.
9. Master Switch -- OFF.
10. Doors -- UNLATCH PRIOR TO TOUCHDOWN.
11. Touchdown -- SLIGHTLY TAIL LOW.
12. Ignition Switch -- OFF.
13. Mixture -- IDLE CUTOFF.
14. Brakes -- APPLY HEAVILY.

DITCHING

1. Radio -- TRANSMIT MAYDAY on 121.5 MHz, giving location and intentions and SQUAWK 7700.
2. Heavy Objects (in baggage area) -- SECURE OR JETTISON (if possible).
3. Passenger Seat Backs -- MOST UPRIGHT POSITION.
4. Seats and Seat Belts -- SECURE.
5. Wing Flaps -- 20° to 30°.
6. Power -- ESTABLISH 300 FT/MIN DESCENT AT 55 KIAS.

NOTE

 If no power is available, approach at 65 KIAS with flaps up or at 60 KIAS with 10° flaps.

7. Approach -- High Winds, Heavy Seas -- INTO THE WIND.
Light Winds, Heavy Swells -- PARALLEL TO SWELLS.
8. Cabin Doors -- UNLATCH.
9. Touchdown -- LEVEL ATTITUDE AT ESTABLISHED RATE OF DESCENT.
10. Face -- CUSHION at touchdown with folded coat.
11. ELT -- Activate.
12. Airplane -- EVACUATE through cabin doors. If necessary, open window and flood cabin to equalize pressure so doors can be opened.
13. Life Vests and Raft -- INFLATE WHEN CLEAR OF AIRPLANE.

FIRES

DURING START ON GROUND

1. **Ignition Switch -- START, Continue Cranking** to get a start which would suck the flames and accumulated fuel into the engine.

If engine starts:

2. Power -- 1700 RPM for a few minutes.
3. Engine -- SHUTDOWN and inspect for damage.

If engine fails to start:

4. **Throttle -- FULL OPEN.**
5. **Mixture -- IDLE CUT OFF.**
6. **Cranking -- CONTINUE.**
7. **Fuel Shutoff Valve -- OFF (Pull Full Out).**
8. **Auxiliary Fuel Pump Switch -- OFF.**
9. Fire Extinguisher -- OBTAIN (have ground attendants obtain if not installed).
10. Engine -- SECURE.
 - a. Master Switch -- OFF.
 - b. Ignition Switch -- OFF
11. Parking Brake -- RELEASE.
12. Airplane -- EVACUATE.
13. Fire -- EXTINGUISH using fire extinguisher, wool blanket, or dirt.
14. Fire Damage -- INSPECT, repair damage or replace damaged components or wiring before conducting another flight.

ENGINE FIRE IN FLIGHT

1. **Mixture -- IDLE CUT OFF.**
2. **Fuel Shutoff Valve -- OFF (Pull Full Out).**
3. **Auxiliary Fuel Pump Switch -- OFF.**
4. **Master Switch -- OFF.**
5. Cabin Heat and Air -- OFF (except overhead vents).
6. Airspeed -- 100 KIAS (If fire is not extinguished, increase glide speed to find an airspeed - within airspeed limitations - which will provide an incombustible mixture).
7. Forced Landing -- EXECUTE (as described in Emergency Landing Without Engine Power).

ELECTRICAL FIRE IN FLIGHT

1. **Master Switch -- OFF.**
2. **Vents, Cabin Air, Heat -- CLOSED.**
3. **Fire Extinguisher -- ACTIVATE** (if available).
4. Avionics Master Switch -- OFF.
5. All Other Switches (except ignition switch) -- OFF.

 **WARNING**

AFTER DISCHARGING FIRE EXTINGUISHER AND ASCERTAINING THAT FIRE HAS BEEN EXTINGUISHED, VENTILATE THE CABIN.

6. Vents/Cabin Air/Heat -- OPEN when it is ascertained that fire is completely extinguished.

If fire has been extinguished and electrical power is necessary for continuance of flight to nearest suitable airport or landing area:

7. Master Switch -- ON.
8. Circuit Breakers -- CHECK for faulty circuit, do not reset.
9. Radio Switches -- OFF.
10. Avionics Master Switch -- ON.
11. Radio/Electrical Switches -- ON one at a time, with delay after each until short circuit is localized.

CABIN FIRE

1. **Master Switch -- OFF.**
2. **Vents/Cabin Air/Heat -- CLOSED** (to avoid drafts).
3. **Fire Extinguisher -- ACTIVATE** (if available).

 **WARNING**

AFTER DISCHARGING FIRE EXTINGUISHER AND ASCERTAINING THAT FIRE HAS BEEN EXTINGUISHED, VENTILATE THE CABIN.

4. Vents/Cabin Air/Heat -- Open when it is ascertained that fire is completely extinguished.
5. Land the airplane as soon as possible to inspect for damage.

WING FIRE

1. **Landing/Taxi Light Switches -- OFF.**
2. **Navigation Light Switch -- OFF.**
3. **Strobe Light Switch -- OFF.**
4. **Pitot Heat Switch -- OFF.**

NOTE

Perform a sideslip to keep the flames away from the fuel tank and cabin. Land as soon as possible using flaps only as required for final approach and touchdown.

ICING

INADVERTENT ICING ENCOUNTER

1. **Turn pitot heat switch ON.**
2. **Turn back or change altitude** to obtain an outside air temperature that is less conducive to icing.
3. **Pull cabin heat control full out and open defroster outlets** to obtain maximum windshield defroster airflow. Adjust cabin air control to get maximum defroster heat and airflow.
4. Watch for signs of engine-related icing conditions. An unexplained loss in engine speed could be caused by ice blocking the air intake filter, or, in extremely rare instances, ice completely blocking the fuel injection air reference tubes. Change the throttle position to obtain maximum RPM. This may require either advancing or retarding the throttle, dependent on where ice has accumulated in the system. Adjust mixture, as required, for maximum RPM.
5. Plan a landing at the nearest airport. With an extremely rapid ice build up, select a suitable "off airport" landing site.
6. With an ice accumulation of 1/4 inch or more on the wing leading edges, be prepared for significantly higher stall speed and a longer landing roll.
7. Leave wing flaps retracted. With a severe ice build up on the horizontal tail, the change in wing wake airflow direction caused by wing flap extension could result in a loss of elevator effectiveness.
8. Open left window and, if practical, scrape ice from a portion of the windshield for visibility in the landing approach.
9. Perform a landing approach using a forward slip, if necessary, for improved visibility.

10. Approach at 65 to 75 KIAS depending upon the amount of the accumulation.
11. Perform a landing in level attitude.

**STATIC SOURCE BLOCKAGE
(Erroneous Instrument Reading Suspected)**

1. **Static Pressure Alternate Source Valve -- PULL ON.**
2. Airspeed -- Consult appropriate calibration tables in Section 5.

LANDING WITH A FLAT MAIN TIRE

1. Approach -- NORMAL.
2. Wing Flaps -- 30°.
3. Touchdown -- GOOD MAIN TIRE FIRST, hold airplane off flat tire as long as possible, with aileron control.
4. Directional Control -- MAINTAIN using brake on good wheel as required.

LANDING WITH A FLAT NOSE TIRE

1. Approach -- NORMAL.
2. Flaps -- AS REQUIRED.
3. Touchdown -- ON MAINS, hold nose wheel off the ground as long as possible.
4. When nose wheel touches down, maintain full up elevator as airplane slows to stop.

ELECTRICAL POWER SUPPLY SYSTEM MALFUNCTIONS

AMMETER SHOWS EXCESSIVE RATE OF CHARGE (Full Scale Deflection)

1. Alternator -- OFF.

CAUTION

WITH THE ALTERNATOR SIDE OF THE MASTER SWITCH OFF, COMPASS DEVIATIONS OF AS MUCH AS 25° MAY OCCUR.

2. Nonessential Electrical Equipment -- OFF.
3. Flight -- TERMINATE as soon as practical.

LOW VOLTAGE ANNUNCIATOR (VOLTS) ILLUMINATES DURING FLIGHT (Ammeter Indicates Discharge)

NOTE

Illumination of "VOLTS" on the annunciator panel may occur during low RPM conditions with an electrical load on the system such as during a low RPM taxi. Under these conditions, the annunciator will go out at higher RPM. The master switch need not be recycled since an overvoltage condition has not occurred to deactivate the alternator system.

1. Avionics Master Switch -- OFF.
2. Alternator Circuit Breaker (ALT FLD) -- CHECK IN.
3. Master Switch -- OFF (both sides).
4. Master Switch -- ON.
5. Low Voltage Annunciator (VOLTS) -- CHECK OFF.
6. Avionics Master Switch -- ON.

If low voltage annunciator (VOLTS) illuminates again:

7. Alternator -- OFF.
8. Nonessential Radio and Electrical Equipment -- OFF.
9. Flight -- TERMINATE as soon as practical.

VACUUM SYSTEM FAILURE

Left Vacuum (L VAC) Annunciator or Right Vacuum (VAC R) Annunciator Illuminates.

 CAUTION

IF VACUUM IS NOT WITHIN NORMAL OPERATING LIMITS, A FAILURE HAS OCCURRED IN THE VACUUM SYSTEM AND PARTIAL PANEL PROCEDURES MAY BE REQUIRED FOR CONTINUED FLIGHT.

1. **Vacuum Gage** -- CHECK to ensure vacuum within normal operating limits.

AMPLIFIED EMERGENCY PROCEDURES

The following Amplified Emergency Procedures elaborate upon information contained in the Emergency Procedures Checklists portion of this section. These procedures also include information not readily adaptable to a checklist format, and material to which a pilot could not be expected to refer in resolution of a specific emergency. This information should be reviewed in detail prior to flying the airplane, as well as reviewed on a regular basis to keep pilot's knowledge of procedures fresh.

ENGINE FAILURE

 If an engine failure occurs during the takeoff roll, the most important thing to do is stop the airplane on the remaining runway. Those extra items on the checklist will provide added safety after a failure of this type.

Prompt lowering of the nose to maintain airspeed and establish a glide attitude is the first response to an engine failure after takeoff. In most cases, the landing should be planned straight ahead with only small changes in direction to avoid obstructions. Altitude and airspeed are seldom sufficient to execute a 180° gliding turn necessary to return to the runway. The checklist procedures assume that adequate time exists to secure the fuel and ignition systems prior to touchdown.

After an engine failure in flight, the most important course of action is to continue flying the airplane. Best glide speed as shown in Figure 3-1 should be established as quickly as possible. While gliding toward a suitable landing area, an effort should be made to identify the cause of the failure. If time permits, an engine restart should be attempted as shown in the checklist. If the engine cannot be restarted, a forced landing without power must be completed.

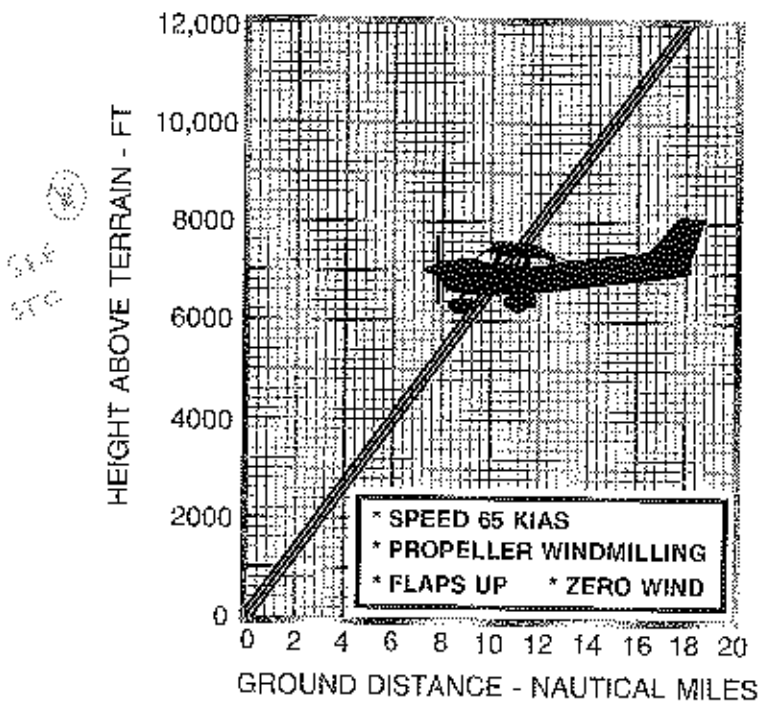

0505C1011

Figure 3-1. Maximum Glide

FORCED LANDINGS

If all attempts to restart the engine fail and a forced landing is imminent, select a suitable field and prepare for the landing as discussed under the Emergency Landing Without Engine Power checklist. Transmit Mayday message on 121.5 MHz giving location and intentions and squawk 7700.

Before attempting an "off airport" landing with engine power available, one should fly over the landing area at a safe but low altitude to inspect the terrain for obstructions and surface conditions, proceeding as discussed under the Precautionary Landing With Engine Power checklist.

Prepare for ditching by securing or jettisoning heavy objects located in the baggage area and collect folded coats for protection of occupants' face at touchdown. Transmit Mayday message on 121.5 MHz giving location and intentions and squawk 7700. Avoid a landing flare because of difficulty in judging height over a water surface. The checklist assumes the availability of power to make a precautionary water landing. If power is not available, use of the airspeeds noted with minimum flap extension will provide a more favorable attitude for a power off ditching.

In a forced landing situation, do not set the AVIONICS MASTER switch or the airplane MASTER switch to the OFF position until a landing is assured. When these switches are in the OFF position, the airplane electrical systems are de-energized.

Before performing a forced landing, especially in remote and mountainous areas, activate the ELT transmitter by positioning the cockpit-mounted switch to the ON position. For complete information on ELT operation, refer to the Supplements, Section 9.

LANDING WITHOUT ELEVATOR CONTROL

Trim for horizontal flight (with an airspeed of approximately 65 KIAS and flaps set to 20°) by using throttle and elevator trim controls. Then **do not change the elevator trim control setting.** control the glide angle by adjusting power exclusively.

At the landing flare (round-out), the nose down moment resulting from power reduction is an adverse factor and the airplane may land on the nose wheel. Consequently, at flare, the elevator trim control should be adjusted toward the full nose up position and the power adjusted so that the airplane will rotate to the horizontal attitude for touchdown. Close the throttle at touchdown.

FIRES

Although engine fires are extremely rare in flight, the steps of the appropriate checklist should be followed if one is encountered. After completion of this procedure, execute a forced landing. Do not attempt to restart the engine.

The initial indication of an electrical fire is usually the odor of burning insulation. The checklist for this problem should result in elimination of the fire.

EMERGENCY OPERATION IN CLOUDS (Total Vacuum System Failure)

If both the vacuum pumps fail in flight, the directional indicator and attitude indicator will be disabled, and the pilot will have to rely on the turn coordinator if he inadvertently flies into clouds. If an autopilot is installed, it too may be affected. Refer to Section 9, Supplements, for additional details concerning autopilot operation. The following instructions assume that only the electrically powered turn coordinator is operative, and that the pilot is not completely proficient in instrument flying.

EXECUTING A 180° TURN IN CLOUDS

Upon inadvertently entering the clouds, an immediate plan should be made to turn back as follows:

1. Note the compass heading.
2. Using the clock, initiate a standard rate left turn, holding the turn coordinator symbolic airplane wing opposite the lower left index mark for 60 seconds. Then roll back to level flight by leveling the miniature airplane.

3. Check accuracy of the turn by observing the compass heading which should be the reciprocal of the original heading.
4. If necessary, adjust heading primarily with skidding motions rather than rolling motions so that the compass will read more accurately.
5. Maintain altitude and airspeed by cautious application of elevator control. Avoid over controlling by keeping the hands off the control wheel as much as possible and steering only with rudder.

EMERGENCY DESCENT THROUGH CLOUDS

If conditions prevent return to VFR flight using a 180° turn, a descent through a cloud deck to VFR conditions may be appropriate. If possible, obtain radio clearance for an emergency descent through clouds. To guard against a spiral dive, choose an easterly or westerly heading to minimize compass card swings due to changing bank angles. In addition, keep hands off the control wheel and steer a straight course with rudder control by monitoring the turn coordinator. Occasionally check the compass heading and make minor corrections to hold an approximate course. Before descending into the clouds, set up a stabilized letdown condition as follows:

1. Apply full rich mixture.
2. Reduce power to set up a 500 to 800 ft/min rate of descent.
3. Adjust the elevator trim for a stabilized descent at 70-80 KIAS.
4. Keep hands off the control wheel.
5. Monitor turn coordinator and make corrections by rudder alone.
6. Check trend of compass card movement and make cautious corrections with rudder to stop the turn.
7. Upon breaking out of clouds, resume normal cruising flight.

RECOVERY FROM SPIRAL DIVE IN THE CLOUDS

If a spiral is encountered in the clouds, proceed as follows:

1. Retard throttle to idle position.
2. Stop the turn by using coordinated aileron and rudder control to align the symbolic airplane in the turn coordinator with the horizon reference line.
3. Cautiously apply elevator back pressure to slowly reduce the airspeed to 80 KIAS.
4. Adjust the elevator trim control to maintain an 80 KIAS glide.
5. Keep hands off the control wheel, using rudder control to hold a straight heading.
6. Clear engine occasionally, but avoid using enough power to disturb the trimmed glide.
7. Upon breaking out of clouds, resume normal cruising flight.

INADVERTENT FLIGHT INTO ICING CONDITIONS

Flight into icing conditions is **prohibited** and extremely dangerous. An inadvertent encounter with these conditions can best be handled using the checklist procedures. The best procedure, of course, is to turn back or change altitude to escape icing conditions.

During these encounters, an unexplained loss in engine speed could be caused by ice blocking the air intake filter, or, in extremely rare instances, ice completely blocking the fuel injection air reference tubes. In either case, the throttle should be positioned to obtain maximum RPM (in some instances, the throttle may need to be retarded for maximum power). The mixture should then be adjusted, as required, to obtain maximum RPM.

STATIC SOURCE BLOCKED

If erroneous readings of the static source instruments (airspeed, altimeter and vertical speed) are suspected, the static pressure alternate source valve should be pulled ON, thereby supplying static pressure to these instruments from the cabin.

When using the alternate static source, refer to the Alternate Static Source Airspeed Calibration table in Section 5, Performance, for additional information.

Maximum airspeed and altimeter variation from normal is 4 knots and 30 feet over the normal operating range with the window(s) closed. See Section 5, Performance, for additional airspeed calibration data.

SPINS

Should an inadvertent spin occur, the following recovery procedure should be used:

1. RETARD THROTTLE TO IDLE POSITION.
2. PLACE AILERONS IN NEUTRAL POSITION.
3. APPLY AND **HOLD** FULL RUDDER OPPOSITE TO THE DIRECTION OF ROTATION.
4. JUST **AFTER** THE RUDDER REACHES THE STOP, MOVE THE CONTROL WHEEL **BRISKLY** FORWARD FAR ENOUGH TO BREAK THE STALL. Full down elevator may be required at aft center of gravity loadings to assure optimum recoveries.
5. **HOLD** THESE CONTROL INPUTS UNTIL ROTATION STOPS. Premature relaxation of the control inputs may extend the recovery.
6. AS ROTATION STOPS, NEUTRALIZE RUDDER, AND MAKE A SMOOTH RECOVERY FROM THE RESULTING DIVE.

NOTE

If disorientation precludes a visual determination of the direction of rotation, the symbolic airplane in the turn coordinator may be referred to for this information.

For additional information on spins and spin recovery, see the discussion under SPINS in Normal Procedures (Section 4).

ROUGH ENGINE OPERATION OR LOSS OF POWER

SPARK PLUG FOULING

A slight engine roughness in flight may be caused by one or more spark plugs becoming fouled by carbon or lead deposits. This may be verified by turning the ignition switch momentarily from BOTH to either L or R position. An obvious power loss in single ignition operation is evidence of spark plug or magneto trouble. Assuming that spark plugs are the more likely cause, lean the mixture to the recommended lean setting for cruising flight. If the problem does not clear up in several minutes, determine if a richer mixture setting will produce smoother operation. If not, proceed to the nearest airport for repairs using the BOTH position of the ignition switch unless extreme roughness dictates the use of a single ignition position.

MAGNETO MALFUNCTION

A sudden engine roughness or misfiring is usually evidence of magneto problems. Switching from BOTH to either L or R ignition switch position will identify which magneto is malfunctioning. Select different power settings and enrichen the mixture to determine if continued operation on BOTH magnetos is possible. If not, switch to the good magneto and proceed to the nearest airport for repairs.

ENGINE-DRIVEN FUEL PUMP FAILURE

Failure of the engine-driven fuel pump will result in an immediate loss of engine power, similar to fuel exhaustion or starvation, but while operating from a fuel tank containing adequate fuel. A sudden reduction in indicated fuel flow will occur just before loss of engine power.

If the engine-driven fuel pump fails, immediately set the auxiliary fuel pump switch (FUEL PUMP) to the ON position to restore engine power. The flight should be terminated as soon as practical and the engine-driven fuel pump repaired.

| Action | Compliance Time | Special Instructions |
|--|---|--|
| <p>(3) Add the following information to the end of page 3-20, Section 3 Emergency Procedures of the Cessna 172R or 172S Pilot's Operating Handbook (POH) and FAA-approved Airplane Flight Manual (AFM):</p> <p>"IDLE POWER ENGINE ROUGHNESS</p> <p>An excessively rich idle fuel flow may cause low speed engine roughness during flight. During most in-flight low engine speeds (power off stalls, approach to landing, etc.), the mixture control is normally in the full-rich position. However, to improve engine roughness (caused by an improperly adjusted fuel servo) during low engine speeds while in flight, you should rotate the vernier mixture control (leaning of fuel mixture). You may also have to lean the fuel mixture if this low engine speed results in power loss and you need to restart the engine during flight. In all cases, you should land the airplane at the nearest airport for repairs if low speed engine roughness requires you to adjust the fuel mixture control to improve engine operation."</p> | <p>Within the next 10 hours TIS after April 20, 2001 (the effective date of this AD), unless already accomplished</p> | <p>The owner/operator holding at least a private pilot certificate as authorized by section 43.7 of the Federal Aviation Regulations (14 CFR 43.7) may insert the information into the POH as specified in paragraph (d)(3) of this AD. You may insert a copy of this AD into the appropriate sections of the POH to comply with this action. Make an entry into the aircraft records showing compliance with portion of the AD in accordance with section 43.9 of the Federal Aviation Regulations (14 CFR 43.9).</p> |

.....

EXCESSIVE FUEL VAPOR INDICATIONS

Excessive fuel vapor is most likely to be generated during ground operations when operating at higher altitudes, in unusually warm temperatures or with more volatile fuel blends. Operation at or near idle RPM (low fuel flow) for extended periods will increase the chances of fuel vapor generation. (See "Leaning For Ground Operations", Section 4.)

Indicated fuel flow that is not stable (sudden changes greater than 1 gal/hr) is a sign that fuel vapor may be present in the system. Fuel flow indications that become less stable (increasing changes) may lead to power surges and power loss if not corrected.

If in-flight vapor is suspected, smoother engine operation may result from making the following changes (singly or together): set the auxiliary fuel pump switch to the ON position, lean the mixture for smooth engine operation and select another fuel tank. Increasing the airspeed to provide more air flow through the cowling will aid in cooling the engine and fuel system components.

LOW OIL PRESSURE

If the low oil pressure annunciator (OIL PRESS) illuminates and oil temperature remains normal, the oil pressure sending unit or relief valve may be malfunctioning. Land at the nearest airport to inspect the source of trouble.

If a total loss of oil pressure is accompanied by a rise in oil temperature, there is good reason to suspect an engine failure is imminent. Reduce engine power immediately and select a suitable forced landing field. Use only the minimum power required to reach the desired touchdown spot.

ELECTRICAL POWER SUPPLY SYSTEM MALFUNCTIONS

Malfunctions in the electrical power supply system can be detected by periodic monitoring of the ammeter and low voltage annunciator (VOLTS); however, the cause of these malfunctions is usually difficult to determine. A broken alternator drive belt or wiring is most likely the cause of alternator failures, although other factors could cause the problem. A defective alternator control unit can also cause malfunctions. Problems of this nature constitute an electrical emergency and should be dealt with immediately. Electrical power malfunctions usually fall into two categories: excessive rate of charge and insufficient rate of charge. The following paragraphs describe the recommended remedy for each situation.

EXCESSIVE RATE OF CHARGE

After engine starting and heavy electrical usage at low engine speeds (such as extended taxiing) the battery condition will be low enough to accept above normal charging during the initial part of a flight. However, after thirty minutes of cruising flight, the ammeter should be indicating less than two needle widths of charging current. If the charging rate were to remain above this value on a long flight, the battery would overheat and evaporate the electrolyte at an excessive rate.

Electronic components in the electrical system can be adversely affected by higher than normal voltage. The alternator control unit includes an overvoltage sensor which normally will automatically shut down the alternator if the charge voltage reaches approximately 31.5 volts. If the overvoltage sensor malfunctions, as evidenced by an excessive rate of charge shown on the ammeter, the alternator should be turned off, nonessential electrical equipment turned off and the flight terminated as soon as practical.

INSUFFICIENT RATE OF CHARGE

NOTE

The low voltage annunciator (VOLTS) may come on and ammeter discharge indications may occur during low RPM conditions with an electrical load on the system, such as during a low RPM taxi. Under these conditions, the annunciator will go off at higher RPM.

If the overvoltage sensor should shut down the alternator and trip the alternator circuit breaker (ALT FLD), or if the alternator output is low, a discharge rate will be shown on the ammeter followed by illumination of the low voltage annunciator (VOLTS). Since this may be a "nuisance" trip out, an attempt should be made to reactivate the alternator system. To reactivate, set the avionics master switch to the OFF position, check that the alternator circuit breaker (ALT FLD) is in, then set both sides of the master switch to the OFF position and then to the ON position. If the problem no longer exists, normal alternator charging will resume and the low voltage annunciator (VOLTS) will go off. The avionics master switch may then be returned to the ON position.

If the annunciator illuminates again, a malfunction is confirmed. In this event, the flight should be terminated and/or the current drain on the battery minimized because the battery can supply the electrical system for only a limited period of time. Battery power must be conserved for later operation of the wing flaps and, if the emergency occurs at night, for possible use of the landing lights during landing.

OTHER EMERGENCIES

WINDSHIELD DAMAGE

If a bird strike or other incident should damage the windshield in flight to the point of creating an opening, a significant loss in performance may be expected. This loss may be minimized in some cases (depending on amount of damage, altitude, etc.) by opening the side windows while the airplane is maneuvered for a landing at the nearest airport. If airplane performance or other adverse conditions preclude landing at an airport, prepare for an "off airport" landing in accordance with the Precautionary Landing With Engine Power or Ditching checklists.

SECTION 4 NORMAL PROCEDURES

TABLE OF CONTENTS

Page

| | |
|--------------------|-----|
| Introduction | 4-5 |
|--------------------|-----|

AIRSPPEEDS

| | |
|--------------------------------------|-----|
| Airspeeds For Normal Operation | 4-5 |
|--------------------------------------|-----|

CHECKLIST PROCEDURES

| | |
|---|------|
| Preflight Inspection | 4-7 |
| Cabin | 4-7 |
| Empennage | 4-8 |
| Right Wing, Trailing Edge | 4-8 |
| Right Wing | 4-8 |
| Nose | 4-9 |
| Left Wing | 4-10 |
| Left Wing, Leading Edge | 4-11 |
| Left Wing, Trailing Edge | 4-11 |
| Before Starting Engine | 4-11 |
| Starting Engine (With Battery) | 4-12 |
| Starting Engine (With External Power) | 4-13 |
| Before Takeoff | 4-15 |
| Takeoff | 4-15 |
| Normal Takeoff | 4-15 |
| Short Field Takeoff | 4-16 |
| Enroute Climb | 4-16 |
| Cruise | 4-16 |
| Descent | 4-16 |
| Before Landing | 4-16 |

TABLE OF CONTENTS (Continued)

| | Page |
|---|------|
| Landing | 4-17 |
| Normal Landing | 4-17 |
| Short Field Landing | 4-17 |
| Balked Landing | 4-17 |
| After Landing | 4-17 |
| Securing Airplane | 4-17 |
| AMPLIFIED PROCEDURES | |
| Preflight Inspection | 4-18 |
| Starting Engine | 4-19 |
| Recommended Starter Duty Cycle | 4-20 |
| Leaning For Ground Operations | 4-21 |
| Taxiing | 4-21 |
| Before Takeoff | 4-23 |
| Warm Up | 4-23 |
| Magnetos Check | 4-23 |
| Alternator Check | 4-23 |
| Landing Lights | 4-24 |
| Takeoff | 4-24 |
| Power Check | 4-24 |
| Wing Flap Settings | 4-25 |
| Crosswind Takeoff | 4-25 |
| Enroute Climb | 4-25 |
| Cruise | 4-26 |
| Leaning With EGT Indicator | 4-27 |
| Fuel Savings Procedures for Flight Training Operations .. | 4-28 |
| Fuel Vapor Procedures | 4-29 |
| Stalls | 4-30 |
| Spins | 4-30 |

TABLE OF CONTENTS (Continued)

Page

| | |
|---|------|
| Landing | 4-32 |
| Normal Landing | 4-32 |
| Short Field Landing | 4-33 |
| Crosswind Landing | 4-33 |
| Balked Landing | 4-33 |
| Cold Weather Operation | 4-34 |
| Winterization Kit | 4-35 |
| Hot Weather Operation | 4-36 |
| Noise Characteristics And Noise Reduction | 4-36 |

1. The first part of the document discusses the importance of maintaining accurate records of all transactions and activities. It emphasizes that this is crucial for ensuring transparency and accountability in the organization's operations.

2. The second part of the document outlines the various methods and tools used to collect and analyze data. It highlights the need for consistent and reliable data collection processes to support informed decision-making.

3. The third part of the document focuses on the role of technology in modern data management. It discusses how advanced software solutions can streamline data collection, storage, and analysis, thereby improving efficiency and accuracy.

4. The fourth part of the document addresses the challenges associated with data security and privacy. It provides guidelines for implementing robust security measures to protect sensitive information from unauthorized access and breaches.

5. The fifth part of the document explores the importance of data quality and integrity. It discusses strategies for identifying and correcting errors in data collection and ensuring that the information used for analysis is accurate and reliable.

6. The sixth part of the document discusses the ethical considerations surrounding data collection and use. It emphasizes the need for transparency in data practices and the importance of obtaining informed consent from individuals whose data is being collected.

7. The seventh part of the document provides a summary of the key findings and recommendations. It reiterates the importance of a data-driven approach and offers practical advice for implementing effective data management practices.

8. The final part of the document includes a list of references and a glossary of key terms. This section is designed to provide additional resources for readers interested in further exploring the topics discussed in the document.

INTRODUCTION

Section 4 provides checklist and amplified procedures for the conduct of normal operation. Normal procedures associated with optional systems can be found in the Supplements, Section 9.

AIR SPEEDS

AIRSPEEDS FOR NORMAL OPERATION

Unless otherwise noted, the following speeds are based on a maximum weight of 2450 pounds and may be used for any lesser weight.

SEE
SEC

| | |
|--|------------|
| Takeoff: | |
| Normal Climb Out | 70-80 KIAS |
| Short Field Takeoff, Flaps 10°, Speed at 50 Feet | 57 KIAS |
| Enroute Climb, Flaps Up: | |
| Normal, Sea Level | 75-85 KIAS |
| Normal, 10,000 Feet | 70-80 KIAS |
| Best Rate-of-Climb, Sea Level | 79 KIAS |
| Best Rate-of-Climb, 10,000 Feet | 71 KIAS |
| Best Angle-of-Climb, Sea Level | 60 KIAS |
| Best Angle-of-Climb, 10,000 Feet | 65 KIAS |
| Landing Approach: | |
| Normal Approach, Flaps Up | 65-75 KIAS |
| Normal Approach, Flaps 30° | 60-70 KIAS |
| Short Field Approach, Flaps 30° | 62 KIAS |
| Balked Landing: | |
| Maximum Power, Flaps 20° | 55 KIAS |
| Maximum Recommended Turbulent Air Penetration Speed: | |
| 2450 Lbs | 99 KIAS |
| 2000 Lbs | 92 KIAS |
| 1600 Lbs | 82 KIAS |
| Maximum Demonstrated Crosswind Velocity: | |
| Takeoff or Landing | 15 KNOTS |

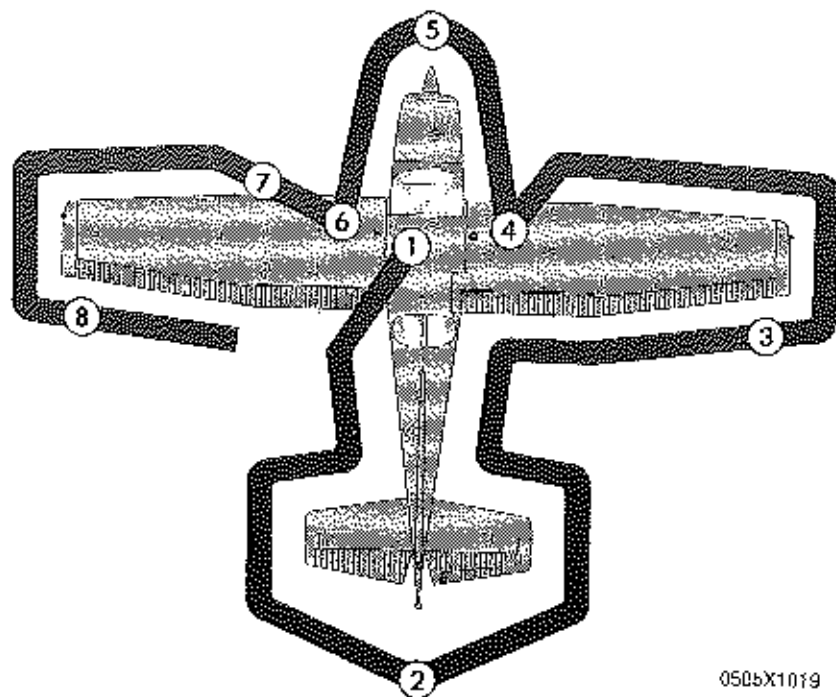

0505X1019

NOTE

Visually check airplane for general condition during walk-around inspection. Airplane should be parked in a normal ground attitude (refer to Figure 1-1) to ensure that fuel drain valves allow for accurate sampling. Use of the refueling steps and assist handles will simplify access to the upper wing surfaces for visual checks and refueling operations. In cold weather, remove even small accumulations of frost, ice or snow from wing, tail and control surfaces. Also, make sure that control surfaces contain no internal accumulations of ice or debris. Prior to flight, check that pitot heater is warm to touch within 30 seconds with battery and pitot heat switches on. If a night flight is planned, check operation of all lights, and make sure a flashlight is available.

Figure 4-1. Preflight Inspection

CHECKLIST PROCEDURES

PREFLIGHT INSPECTION

① CABIN

1. Pitot Tube Cover -- REMOVE. Check for pitot blockage.
2. Pilot's Operating Handbook -- AVAILABLE IN THE AIRPLANE.
3. Airplane Weight and Balance -- CHECKED.
4. Parking Brake -- SET.
5. Control Wheel Lock -- REMOVE.
6. Ignition Switch -- OFF.
7. Avionics Master Switch -- OFF.

WARNING

WHEN TURNING ON THE MASTER SWITCH, USING AN EXTERNAL POWER SOURCE, OR PULLING THE PROPELLER THROUGH BY HAND, TREAT THE PROPELLER AS IF THE IGNITION SWITCH WERE ON. DO NOT STAND, NOR ALLOW ANYONE ELSE TO STAND, WITHIN THE ARC OF THE PROPELLER, SINCE A LOOSE OR BROKEN WIRE OR A COMPONENT MALFUNCTION COULD CAUSE THE PROPELLER TO ROTATE.

8. Master Switch -- ON.
9. Fuel Quantity Indicators -- CHECK QUANTITY and ENSURE LOW FUEL ANNUNCIATORS (L. LOW FUEL R) ARE EXTINGUISHED.
10. Avionics Master Switch -- ON.
11. Avionics Cooling Fan -- CHECK AUDIBLY FOR OPERATION.
12. Avionics Master Switch -- OFF.
13. Static Pressure Alternate Source Valve -- OFF.
14. Annunciator Panel Switch -- PLACE AND HOLD IN TST POSITION and ensure all annunciators illuminate.

15. Annunciator Panel Test Switch -- RELEASE. Check that appropriate annunciators remain on.

NOTE

When Master Switch is turned ON, some annunciators will flash for approximately 10 seconds before illuminating steadily. When panel TST switch is toggled up and held in position, all remaining lights will flash until the switch is released.

16. Fuel Selector Valve -- BOTH.
17. Fuel Shutoff Valve -- ON (Push Full In).
18. Flaps -- EXTEND.
19. Pitot Heat -- ON. (Carefully check that pitot tube is warm to the touch within 30 seconds.)
20. Pitot Heat -- OFF.
21. Master Switch -- OFF.
22. Elevator Trim -- SET for takeoff.
23. Baggage Door -- CHECK, lock with key.
24. Autopilot Static Source Opening (if installed) -- CHECK for blockage.

② EMPENNAGE

1. Rudder Gust Lock (if installed) -- REMOVE.
2. Tail Tie-Down -- DISCONNECT.
3. Control Surfaces -- CHECK freedom of movement and security.
4. Trim Tab -- CHECK security.
5. Antennas -- CHECK for security of attachment and general condition.

③ RIGHT WING Trailing Edge

1. Aileron -- CHECK freedom of movement and security.
2. Flap -- CHECK for security and condition.

④ RIGHT WING

1. Wing Tie-Down -- DISCONNECT.

2. Main Wheel Tire -- CHECK for proper inflation and general condition (weather checks, tread depth and wear, etc...).
3. Fuel Tank Sump Quick Drain Valves -- DRAIN at least a cupful of fuel (using sampler cup) from each sump location to check for water, sediment, and proper fuel grade before each flight and after each refueling. If water is observed, take further samples until clear and then gently rock wings and lower tail to the ground to move any additional contaminants to the sampling points. Take repeated samples from **all** fuel drain points until **all** contamination has been removed. If contaminants are still present, refer to WARNING below and do not fly airplane.

 **WARNING**

IF, AFTER REPEATED SAMPLING, EVIDENCE OF CONTAMINATION STILL EXISTS, THE AIRPLANE SHOULD NOT BE FLOWN. TANKS SHOULD BE DRAINED AND SYSTEM PURGED BY QUALIFIED MAINTENANCE PERSONNEL. ALL EVIDENCE OF CONTAMINATION MUST BE REMOVED BEFORE FURTHER FLIGHT.

4. Fuel Quantity -- CHECK VISUALLY for desired level.
5. Fuel Filler Cap -- SECURE and VENT UNOBSTRUCTED.

⑤ NOSE

1. Fuel Strainer Quick Drain Valve (Located on bottom of fuselage) -- DRAIN at least a cupful of fuel (using sampler cup) from valve to check for water, sediment, and proper fuel grade before each flight and after each refueling. If water is observed, take further samples until clear and then gently rock wings and lower tail to the ground to move any additional contaminants to the sampling points. Take repeated samples from **all** fuel drain points, including the fuel reservoir and fuel selector, until **all** contamination has been removed. If contaminants are still present, refer to WARNING above and do not fly the airplane.

- Sub*
500 → ② Engine Oil Dipstick/Filter Cap -- CHECK oil level, then check dipstick/filler cap **SECURE. Do not operate with less than five quarts.** Fill to eight quarts for extended flight.
- 3. Engine Cooling Air Inlets -- CLEAR of obstructions.
 - 4. Propeller and Spinner -- CHECK for nicks and security.
 - 5. Air Filter -- CHECK for restrictions by dust or other foreign matter.
 - 6. Nose Wheel Strut and Tire -- CHECK for proper inflation of strut and general condition (weather checks, tread depth and wear, etc...) of tire.
- 7. Left Static Source Opening -- CHECK for blockage.

⑥ LEFT WING

- 1. Fuel Quantity -- CHECK VISUALLY for desired level.
- 2. Fuel Filler Cap -- SECURE and VENT UNOBSTRUCTED.
- 3. Fuel Tank Sump Quick Drain Valves -- DRAIN at least a cupful of fuel (using sampler cup) from each sump location to check for water, sediment, and proper fuel grade before each flight and after each refueling. If water is observed, take further samples until clear and then gently rock wings and lower tail to the ground to move any additional contaminants to the sampling points. Take repeated samples from **all** fuel drain points until **all** contamination has been removed. If contaminants are still present, refer to WARNING on page 4-9 and do not fly airplane.
- 4. Main Wheel Tire -- CHECK for proper inflation and general condition (weather checks, tread depth and wear, etc...).

⑦ LEFT WING Leading Edge

1. Fuel Tank Vent Opening -- CHECK for blockage.
2. Stall Warning Opening -- CHECK for blockage. To check the system, place a clean handkerchief over the vent opening and apply suction; a sound from the warning horn will confirm system operation.
3. Wing Tie-Down -- DISCONNECT.
4. Landing/Taxi Light(s) -- CHECK for condition and cleanliness of cover.

⑧ LEFT WING Trailing Edge

1. Aileron-- CHECK for freedom of movement and security.
2. Flap -- CHECK for security and condition.

BEFORE STARTING ENGINE

1. Preflight Inspection -- COMPLETE.
2. Passenger Briefing -- COMPLETE.
3. Seats and Seat Belts -- ADJUST and LOCK. Ensure inertia reel locking.
4. Brakes -- TEST and SET.
5. Circuit Breakers -- CHECK IN.
6. Electrical Equipment -- OFF.

⚠ CAUTION

THE AVIONICS MASTER SWITCH MUST BE OFF DURING ENGINE START TO PREVENT POSSIBLE DAMAGE TO AVIONICS.

7. Avionics Master Switch -- OFF.
8. Fuel Selector Valve -- BOTH.
9. Fuel Shutoff Valve -- ON (push full in).
10. Avionics Circuit Breakers -- CHECK IN.

STARTING ENGINE (With Battery)

1. Throttle -- OPEN 1/4 INCH.
2. Mixture -- IDLE CUTOFF.
3. Propeller Area -- CLEAR.
4. Master Switch -- ON.
5. Flashing Beacon -- ON.

NOTE

If engine is warm, omit priming procedure of steps 6, 7, and 8 below.

6. Auxiliary Fuel Pump Switch -- ON.
7. Mixture -- SET to FULL RICH (full forward) until stable fuel flow is indicated (usually 3 to 5 seconds), then set to IDLE CUTOFF (full aft) position.
8. Auxiliary Fuel Pump Switch -- OFF.
9. Ignition Switch -- START (release when engine starts).
10. Mixture -- ADVANCE smoothly to RICH when engine starts.

NOTE

If engine floods (engine has been primed too much), turn off auxiliary fuel pump, set mixture to idle cutoff, open throttle 1/2 to full, and motor (crank) engine. When engine starts, set mixture to full rich and close throttle promptly.

11. Oil Pressure -- CHECK.
12. Navigation Lights -- ON as required.
13. Avionics Master Switch -- ON.
14. Radios -- ON.
15. Flaps -- RETRACT.

STARTING ENGINE (With External Power)

1. Throttle -- OPEN 1/4 INCH.
2. Mixture -- IDLE CUTOFF.
3. Propeller Area -- CLEAR.
4. Master Switch -- OFF.
5. External Power -- CONNECT to airplane receptacle.
6. Master Switch -- ON.
7. Flashing Beacon -- ON.

NOTE

If engine is warm, omit priming procedure of steps 8, 9, and 10 below.

8. Auxiliary Fuel Pump Switch -- ON.
9. Mixture -- SET to FULL RICH (full forward) until stable fuel flow is indicated (usually 3 to 5 seconds), then set to IDLE CUTOFF (full aft) position.
10. Auxiliary Fuel Pump Switch -- OFF.
11. Ignition Switch -- START (release when engine starts).
12. Mixture -- ADVANCE smoothly to RICH when engine starts.

NOTE

If engine floods (engine has been primed too much), turn off auxiliary fuel pump, set mixture to idle cutoff, open throttle 1/2 to full, and motor (crank) engine. When engine starts, set mixture to full rich and close throttle promptly.

13. Oil Pressure -- CHECK.
14. External Power -- DISCONNECT from airplane receptacle. Secure external power door.
15. Electrical System -- CHECK FOR PROPER OPERATION.
 - a. Master Switch -- OFF
(disconnects both the battery and alternator from the system).

- b. Taxi and Landing Light Switches -- ON
(to provide an initial electrical load on the system).
- c. Engine RPM -- REDUCE to idle.
(Minimum alternator output occurs at idle.)
- d. Master Switch -- ON (with taxi and landing lights switched on).
(The ammeter should indicate in the negative direction, showing that the alternator output is below the load requirements, but the battery is supplying current to the system.)
- e. Engine RPM -- INCREASE to approximately 1500 RPM
(as engine RPM increases, alternator output should increase to meet the system load requirements).
- f. Ammeter and Low Voltage Annunciator -- CHECK
(the ammeter should indicate in the positive direction, showing that the alternator is supplying current and the Low Voltage Annunciator (VOLTS) should not be lighted).

NOTE

If the indications, as noted in Step "d" and Step "f", are not observed, the electrical system is not functioning properly. Corrective maintenance must be performed to provide for proper electrical system operation before flight.

- 16. Navigation Lights -- ON as required.
- 17. Avionics Master Switch -- ON.
- 18. Radios -- ON.
- 19. Flaps -- RETRACT.

BEFORE TAKEOFF

1. Parking Brake -- SET.
2. Passenger Seat Backs -- MOST UPRIGHT POSITION.
3. Seats and Seat Belts -- CHECK SECURE.
4. Cabin Doors -- CLOSED and LOCKED.
5. Flight Controls -- FREE and CORRECT.
6. Flight Instruments -- CHECK and SET.
7. Fuel Quantity -- CHECK.
8. Mixture -- RICH.
9. Fuel Selector Valve -- RECHECK BOTH.
10. Throttle -- 1800 RPM.
 - a. Magnetos -- CHECK (RPM drop should not exceed 150 RPM on either magneto or 50 RPM differential between magnetos).
 - b. Vacuum Gage -- CHECK.
 - c. Engine Instruments and Ammeter -- CHECK.
11. Annunciator Panel -- Ensure no annunciators are illuminated.
12. Throttle -- CHECK IDLE.
13. Throttle -- 1000 RPM or LESS.
14. Throttle Friction Lock -- ADJUST.
15. Strobe Lights -- AS DESIRED.
16. Radios and Avionics -- SET.
17. NAV/GPS Switch (if installed) -- SET.
18. Autopilot (if installed) -- OFF.
19. Manual Electric Trim (if installed) -- CHECK.
20. Elevator Trim -- SET for takeoff.
21. Wing Flaps -- SET for takeoff (0°-10°).
22. Brakes -- RELEASE.

TAKEOFF

NORMAL TAKEOFF

1. Wing Flaps -- 0°-10°.
2. Throttle -- FULL OPEN.
3. Mixture -- RICH (above 3000 feet, LEAN to obtain maximum RPM).
4. Elevator Control -- LIFT NOSE WHEEL (at 55 KIAS).
5. Climb Speed -- 70-80 KIAS.
6. Wing Flaps -- RETRACT.

SEE
E.T.C.

SHORT FIELD TAKEOFF

1. Wing Flaps -- 10°.
2. Brakes -- APPLY.
3. Throttle -- FULL OPEN.
4. Mixture -- RICH (above 3000 feet, LEAN to obtain maximum RPM).
5. Brakes -- RELEASE.
6. Elevator Control -- SLIGHTLY TAIL LOW.
7. Climb Speed -- 57 KIAS (until all obstacles are cleared).
8. Wing Flaps -- RETRACT slowly after reaching 60 KIAS.

ENROUTE CLIMB

1. Airspeed -- 70-85 KIAS.

NOTE

If a maximum performance climb is necessary, use speeds shown in the Rate Of Climb chart in Section 5.

2. Throttle -- FULL OPEN.
3. Mixture -- RICH (above 3000 feet, LEAN to obtain maximum RPM).

CRUISE

1. Power -- 2000-2400 RPM (No more than 80% is recommended).
2. Elevator Trim -- ADJUST.
3. Mixture -- LEAN.

DESCENT

1. Power -- AS DESIRED.
2. Mixture -- ADJUST for smooth operation.
3. Altimeter -- SET.
4. NAV/GPS Switch -- SET.
5. Fuel Selector Valve -- BOTH.
6. Wing Flaps -- AS DESIRED (0° - 10° below 110 KIAS, 10° - 30° below 85 KIAS).

BEFORE LANDING

1. Pilot and Passenger Seat Backs -- MOST UPRIGHT POSITION.
2. Seats and Seat Belts -- SECURED and LOCKED.
3. Fuel Selector Valve -- BOTH.
4. Mixture -- RICH.
5. Landing/Taxi Lights -- ON.
6. Autopilot (if installed) -- OFF.

LANDING

NORMAL LANDING

1. Airspeed -- 65-75 KIAS (flaps UP).
2. Wing Flaps -- AS DESIRED (0°-10° below 110 KIAS, 10°-30° below 85 KIAS).
3. Airspeed -- 60-70 KIAS (flaps DOWN).
4. Touchdown -- MAIN WHEELS FIRST.
5. Landing Roll -- LOWER NOSE WHEEL GENTLY.
6. Braking -- MINIMUM REQUIRED.

SHORT FIELD LANDING

1. Airspeed -- 65-75 KIAS (flaps UP).
2. Wing Flaps -- FULL DOWN (30°).
3. Airspeed -- 62 KIAS (until flare).
4. Power -- REDUCE to idle after clearing obstacle.
5. Touchdown -- MAIN WHEELS FIRST.
6. Brakes -- APPLY HEAVILY.
7. Wing Flaps -- RETRACT.

BALKED LANDING

1. Throttle -- FULL OPEN.
2. Wing Flaps -- RETRACT TO 20°.
3. Climb Speed -- 55 KIAS.
4. Wing Flaps -- 10° (until obstacles are cleared).
RETRACT (after reaching a safe altitude and 60 KIAS).

AFTER LANDING

1. Wing Flaps -- UP.

SECURING AIRPLANE

1. Parking Brake -- SET.
2. Electrical Equipment, Autopilot (if installed) -- OFF.
3. Avionics Master Switch -- OFF.
4. Mixture -- IDLE CUT OFF (pulled full out).
5. Ignition Switch -- OFF.
6. Master Switch -- OFF.
7. Control Lock -- INSTALL.
8. Fuel Selector Valve -- LEFT or RIGHT to prevent cross feeding.

AMPLIFIED PROCEDURES

PREFLIGHT INSPECTION

The Preflight Inspection, described in Figure 4-1 and adjacent checklist, is required prior to each flight. If the airplane has been in extended storage, has had recent major maintenance, or has been operated from marginal airports, a more extensive exterior inspection is recommended.

After major maintenance has been performed, the flight and trim tab controls should be double checked for free and correct movement and security. The security of all inspection plates on the airplane should be checked following periodic inspections. If the airplane has been waxed or polished, check the external static pressure source hole for stoppage.

If the airplane has been exposed to much ground handling in a crowded hangar, it should be checked for dents and scratches on wings, fuselage, and tail surfaces, damage to navigation and anti-collision lights, damage to nose wheel as a result of exceeding tow limits, and avionics antennas.

Outside storage for long periods may result in dust and dirt accumulation on the induction air filter, obstructions in airspeed system lines, water contaminants in fuel tanks and insect/bird/rodent nests in any opening. If any water is detected in the fuel system, the fuel tank sump quick drain valves, fuel reservoir quick drain valve, and fuel strainer quick drain valve should all be thoroughly drained again. Then, the wings should be gently rocked and the tail lowered to the ground to move any further contaminants to the sampling points. Repeated samples should then be taken at **all** quick drain points until **all** contamination has been removed. If, after repeated sampling, evidence of contamination still exists, the fuel tanks should be completely drained and the fuel system cleaned.

Additionally, if the airplane has been stored outside in windy or gusty areas, or tied down adjacent to taxiing airplanes, special attention should be paid to control surface stops, hinges, and brackots to detect the presence of potential wind damage.

If the airplane has been operated from muddy fields or in snow or slush, check the main and nose gear wheel fairings for obstructions and cleanliness. Operation from a gravel or cinder field will require extra attention to propeller tips and abrasion on leading edges of the horizontal tail. Stone damage to the propeller can seriously reduce the fatigue life of the blades.

Airplanes that are operated from rough fields, especially at high altitudes, are subjected to abnormal landing gear abuse. Frequently check all components of the landing gear, shock strut, tires, and brakes. If the shock strut is insufficiently extended, undue landing and taxi loads will be subjected on the airplane structure.

To prevent loss of fuel in flight, make sure the fuel tank filler caps are tightly sealed after any fuel system check or servicing. Fuel system vents should also be inspected for obstructions, ice or water, especially after exposure to cold, wet weather.

STARTING ENGINE

In cooler weather, the engine compartment temperature drops off rapidly following engine shutdown and the injector nozzle lines remain nearly full of fuel.

However, in warmer weather, engine compartment temperatures may increase rapidly following engine shutdown, and fuel in the lines will vaporize and escape into the intake manifold. Hot weather starting procedures depend considerably on how soon the next engine start is attempted. Within the first 20 to 30 minutes after shutdown, the fuel manifold is adequately primed and the empty injector nozzle lines will fill before the engine dies. However, after approximately 30 minutes, the vaporized fuel in the manifold will have nearly dissipated and some slight "priming" could be required to refill the nozzle lines and keep the engine running after the initial start. Starting a hot engine is facilitated by advancing the mixture control promptly to 1/3 open when the engine starts, and then smoothly to full rich as power develops.

Should the engine tend to die after starting, turn on the auxiliary fuel pump temporarily and adjust the throttle and/or mixture as necessary to keep the engine running. In the event of over priming or flooding, turn off the auxiliary fuel pump, open the throttle from 1/2 to full open, and continue cranking with the mixture full lean. When the engine starts, smoothly advance the mixture control to full rich and retard the throttle to desired idle speed.

If the engine is under primed (most likely in cold weather with a cold engine) it will not start at all, and additional priming will be necessary.

After starting, if the oil pressure gage does not begin to indicate pressure within 30 seconds in the summer time and approximately one minute in very cold weather, stop the engine and investigate. Lack of oil pressure can cause serious engine damage.

NOTE

Additional details concerning cold weather starting and operation may be found under COLD WEATHER OPERATION paragraphs in this section.

RECOMMENDED STARTER DUTY CYCLE

Crank the starter for 10 seconds followed by a 20 second cool down period. This cycle can be repeated two additional times, followed by a ten minute cool down period before resuming cranking. After cool down, crank the starter again, three cycles of 10 seconds followed by 20 seconds of cool down. If the engine still fails to start, an investigation to determine the cause should be initiated.

LEANING FOR GROUND OPERATIONS

1. For all ground operations, after starting the engine and when the engine is running smoothly:
 - a. set the throttle to 1200 RPM.
 - b. lean the mixture for maximum RPM.
 - c. set the throttle to an RPM appropriate for ground operations (800 to 1000 RPM recommended)

NOTE

If ground operation will be required after the BEFORE TAKEOFF checklist is completed, lean the mixture again (as described above) until ready for the TAKEOFF checklist.

TAXIING

When taxiing, it is important that speed and use of brakes be held to a minimum and that all controls be utilized (Refer to Figure 4-2, Taxiing Diagram) to maintain directional control and balance.

Taxiing over loose gravel or cinders should be done at low engine speed to avoid abrasion and stone damage to the propeller tips.

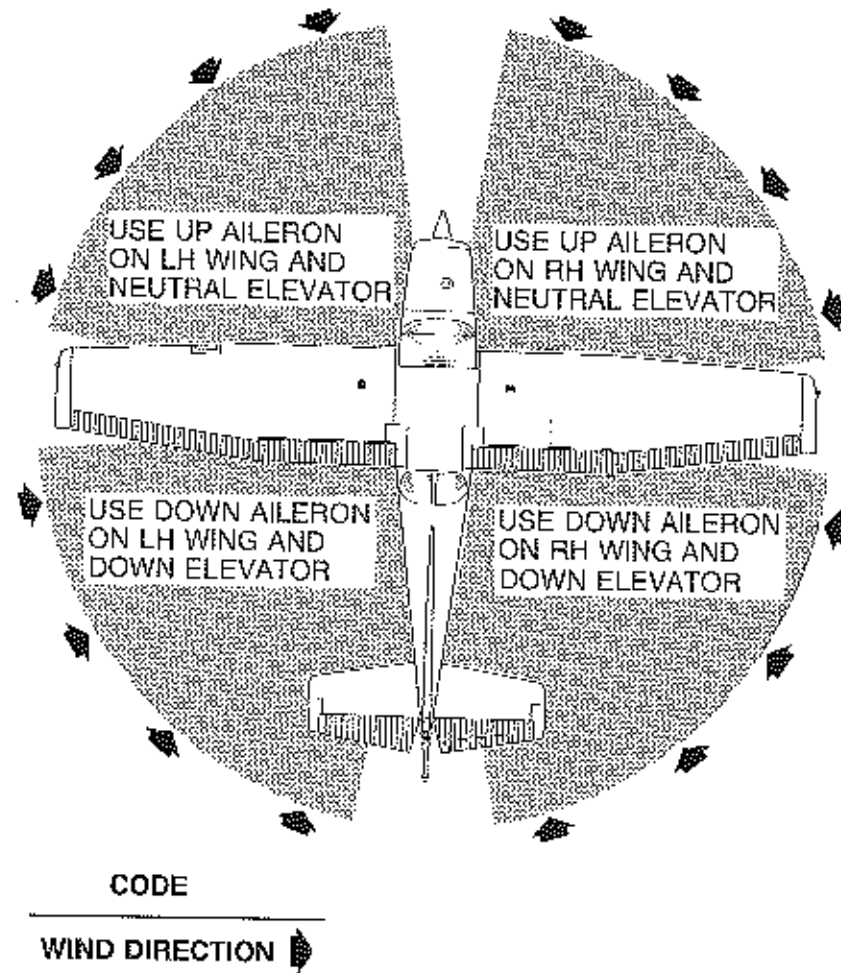

NOTE

Strong quartering tail winds require caution. Avoid sudden bursts of the throttle and sharp braking when the airplane is in this situation. Use the steerable nose wheel and rudder to maintain direction.

0585X1020

Figure 4-2. Taxiing Diagram

BEFORE TAKEOFF

WARM UP

If the engine idles (approximately 600 RPM) and accelerates smoothly, the airplane is ready for takeoff. Since the engine is closely cowled for efficient in-flight engine cooling, precautions should be taken to avoid overheating during prolonged engine operation on the ground. Also, long periods of idling may cause fouled spark plugs.

MAGNETO CHECK

The magneto check should be made at 1800 RPM as follows. Move ignition switch first to R position and note RPM. Next move switch back to BOTH to clear the other set of plugs. Then move switch to the L position, note RPM and return the switch to the BOTH position. RPM drop should not exceed 150 RPM on either magneto or show greater than 50 RPM differential between magnetos. If there is a doubt concerning operation of the ignition system, RPM checks at higher engine speeds will usually confirm whether a deficiency exists.

An absence of RPM drop may be an indication of faulty grounding of one side of the ignition system or should be cause for suspicion that the magneto timing is set in advance of the setting specified.

ALTERNATOR CHECK

Prior to flights where verification of proper alternator and alternator control unit operation is essential (such as night or instrument flights), a positive verification can be made by loading the electrical system momentarily (3 to 5 seconds) with the landing light or by operating the wing flaps during the engine runup (1800 RPM). The ammeter will remain within a needle width of its initial reading if the alternator and alternator control unit are operating properly.

LANDING LIGHTS

If landing lights are to be used to enhance the visibility of the airplane in the traffic pattern or enroute, it is recommended that only the taxi light be used. This will extend the service life of the landing light appreciably.

TAKEOFF

POWER CHECK

*See
SEC 8* It is important to check full throttle engine operation early in the takeoff roll. Any sign of rough engine operation or sluggish engine acceleration is good cause for discontinuing the takeoff. If this occurs, you are justified in making a thorough full throttle static runup before another takeoff is attempted. The engine should run smoothly and turn approximately 2065 - 2165 RPM with mixture leaned to provide maximum RPM.

Full throttle run ups over loose gravel are especially harmful to propeller tips. When takeoffs must be made over a gravel surface, it is very important that the throttle be advanced slowly. This allows the airplane to start rolling before high RPM is developed, and the gravel will be blown back of the propeller rather than pulled into it. When unavoidable small dents appear in the propeller blades, they should be immediately corrected as described in Section 8 under Propeller Care.

Prior to takeoff from fields above 3000 feet elevation, the mixture should be leaned to give maximum RPM in a full throttle, static runup.

After full throttle is applied, adjust the throttle friction lock clockwise to prevent the throttle from creeping back from a maximum power position. Similar friction lock adjustments should be made as required in other flight conditions to maintain a fixed throttle setting.

 **WING FLAP SETTINGS**

See
SRC.

Normal takeoffs are accomplished with wing flaps 0°-10°. Using 10° wing flaps reduces the ground roll and total distance over an obstacle by approximately 10 percent. **Flap deflections greater than 10° are not approved for takeoff.** If 10° wing flaps are used for takeoff, they should be left down until all obstacles are cleared and a safe flap retraction speed of 60 KIAS is reached. On a short field, 10° wing flaps and an obstacle clearance speed of 57 KIAS should be used.

Soft or rough field takeoffs are performed with 10° flaps by lifting the airplane off the ground as soon as practical in a slightly tail low attitude. If no obstacles are ahead, the airplane should be leveled off immediately to accelerate to a higher climb speed. When departing a soft field with an aft C.G. loading, the elevator trim should be adjusted towards the nose down direction to give comfortable control wheel forces during the initial climb.

CROSSWIND TAKEOFF

Takeoffs into strong crosswind conditions normally are performed with the minimum flap setting necessary for the field length, to minimize the drift angle immediately after takeoff. With the ailerons partially deflected into the wind, the airplane is accelerated to a speed slightly higher than normal, then pulled off briskly to prevent possible settling back to the runway while drifting. When clear of the ground, make a coordinated turn into the wind to correct for drift.

ENROUTE CLIMB

Normal enroute climbs are performed with flaps up and **full throttle** and at speeds 5 to 10 knots higher than best rate-of-climb speeds for the best combination of performance, visibility and engine cooling. The mixture should be **full rich** below 3000 feet and may be leaned above 3000 feet for smoother operation or to obtain maximum RPM. For maximum rate of climb, use the best rate-of-climb speeds shown in the Rate of Climb chart in Section 5. If an obstruction dictates the use of a steep climb angle, the best angle-of-climb speed should be used with flaps up and maximum power. Climbs at speeds lower than the best rate-of-climb speed should be of short duration to improve engine cooling.

 **CRUISE**

50%
50% **I** Normal cruise is performed between 60% and 80% power. The engine RPM and corresponding fuel consumption for various altitudes can be determined by using the data in Section 5.

NOTE

Cruising should be done at 80% power as much as practicable until a total of 50 hours has accumulated or oil consumption has stabilized. Operation at this higher power will ensure proper seating of the rings and is applicable to new engines, and engines in service following cylinder replacement or top overhaul of one or more cylinders.

I The Cruise Performance charts in Section 5 provide the pilot with detailed information concerning the cruise performance of the Model 172R in still air. Power and altitude, as well as winds aloft, have a strong influence on the time and fuel needed to complete any flight.

The Cruise Performance Table, Figure 4-3, illustrates the true airspeed and nautical miles per gallon during cruise for various altitudes and percent powers, and is based on standard conditions and zero wind. This table should be used as a guide, along with the available winds aloft information, to determine the most favorable altitude and power setting for a given trip. The selection of cruise altitude on the basis of the most favorable wind conditions and the use of low power settings are significant factors that should be considered on every trip to reduce fuel consumption.

In addition to power settings, proper leaning techniques also contribute to greater range and are figured into cruise performance tables. To achieve the recommended lean mixture fuel consumption figures shown in Section 5, the mixture should be leaned using the exhaust gas temperature (EGT) indicator as noted.

NOTE

I At lower power it may be necessary to richen the mixture slightly to obtain smooth operation.

| ALTITUDE | 80% POWER | | 70% POWER | | 60% POWER | |
|-----------|-----------|------|-----------|------|-----------|------|
| | KTAS | NMPG | KTAS | NMPG | KTAS | NMPG |
| Sea Level | 113 | 12.3 | 108 | 13.4 | 100 | 14.5 |
| 4000 feet | 117 | 12.8 | 111 | 13.9 | 103 | 14.9 |
| 8000 feet | 122 | 13.3 | 115 | 14.3 | 105 | 15.3 |

Figure 4-3. Cruise Performance Table

LEANING USING THE EGT INDICATOR

At or below 80% power in level cruise flight, the exhaust gas temperature (EGT) indicator is used to lean the fuel-air mixture for best performance or economy. The Cruise Performance charts in Section 5 are based on the EGT to adjust the mixture to Recommended Lean per Figure 4-4.

| MIXTURE DESCRIPTION | EXHAUST GAS TEMPERATURE |
|--|-------------------------|
| RECOMMENDED LEAN (Pilot's Operating Handbook) | 50° Rich of Peak EGT |
| BEST ECONOMY | Peak EGT |

Figure 4-4. EGT Table

Use the mixture control vernier adjustment (rotate the knob CCW to lean the mixture) to **slowly** lean, from full rich or maximum RPM mixture, while monitoring the EGT indicator. As the EGT indication begins to increase, continue to **slowly** lean the mixture until an EGT indication decrease is just detectable. Reverse the adjustment **slowly** in the rich direction until an EGT indication decrease is again just detectable, then set the EGT index pointer to match the peak indication. The mixture may be leaned slightly to return to peak EGT or may be further richened to Recommended Lean mixture as desired. **Continuous operation at mixture settings lean of peak EGT is prohibited.** Any change in altitude or throttle position will require that peak EGT be redetermined and the desired mixture be reset. Under some conditions, engine roughness may occur at peak EGT. In this case, operate at Recommended Lean mixture.

As noted in Figure 4-4, operation at peak EGT provides the best fuel economy. Operation at peak EGT results in approximately 4% greater range and approximately a 3 knot decrease in airspeed from the figures shown in the Performance section of this handbook. Recommended Lean mixture provides best level cruise performance (generally close to "best power" or maximum RPM).

NOTE

The EGT indicator requires several seconds to respond to mixture adjustments and changes in exhaust gas temperature. More rapid changes in EGT indication are neither necessary nor desirable. Determining peak EGT and setting the desired mixture should take approximately one minute when the adjustments are made sufficiently slowly and accurately.

FUEL SAVINGS PROCEDURES FOR FLIGHT TRAINING OPERATIONS

For best fuel economy during flight training operations, the following procedures are recommended.

1. After engine start and for all ground operations, set the throttle to 1200 RPM and lean the mixture for maximum RPM. Leave the mixture at this setting until beginning the BEFORE TAKEOFF checklist. After the BEFORE TAKEOFF checklist is complete re-lean the mixture as described above until ready for the TAKEOFF checklist.
2. Lean the mixture for maximum RPM during full throttle climbs above 3000 feet. The mixture may remain leaned (maximum RPM at full throttle) for practicing maneuvers such as stalls and slow flight.
3. Lean the mixture for maximum RPM during all operations at any altitude, including those below 3000 feet, when using 80% or less power.

NOTE

- When cruising or maneuvering at 80% or less power, the mixture may be further leaned until the EGT indicator needle peaks and is then enriched 50°F. This is especially applicable to cross-country training flights, but should be practiced during transition flight to and from the practice area as well.
- Using the above recommended procedures can provide fuel savings in excess of 5% when compared to typical training operations at full rich mixture. In addition, the above procedures will minimize spark plug fouling since the reduction in fuel consumption results in a proportional reduction in tetraethyl lead passing through the engine.

FUEL VAPOR PROCEDURES

The engine fuel system can become susceptible to fuel vapor formation on the ground during warm weather. This will generally occur when the outside ambient air temperature is above 80°F. The situation is further aggravated by the fact that the engine fuel flows are lower at idle and taxi engine speeds. When vapor occurs as evidenced by idle engine speed and fuel flow fluctuations, the following procedures are recommended.

1. With the mixture full rich, set the throttle at 1800 RPM to 2000 RPM. Maintain this power setting for 1 to 2 minutes or until smooth engine operation returns.
2. Retard the throttle to idle to verify normal engine operation.
3. Advance the throttle to 1200 RPM and lean the mixture as described under FUEL SAVINGS PROCEDURES FOR FLIGHT TRAINING OPERATIONS.
4. Just prior to TAKEOFF, apply full throttle, for approximately 10 seconds to verify smooth engine operation for takeoff.

NOTE

When the engine is operated above 1800 RPM, the resulting increased fuel flow also makes for lower fuel temperatures throughout the engine fuel system. This increased flow purges the fuel vapor and the cooler fuel minimizes vapor formation.

In addition to the above procedures, the sections below should be reviewed and where applicable, adhered to:

- Section 2 -- Take note of the placard on "When Switching From Dry Tank".
- Section 3 -- Take note of the excessive fuel vapor procedures in both the checklist and the amplified procedures sections.
- Section 4 -- Take note of the hot weather operational notes and procedures in both the checklist and the amplified procedures sections.
- Section 7 -- Take note of the altitude operational procedures and the section on auxiliary fuel pump operation.

STALLS

The stall characteristics are conventional and aural warning is provided by a stall warning horn which sounds between 5 and 10 knots above the stall in all configurations.

Power off stall speeds at maximum weight for both forward and aft C.G. positions are presented in Section 5.

SPINS

Intentional spins are approved when the airplane is operated in the utility category. Spins with baggage loadings or occupied rear seat(s) are not approved.

However, before attempting to perform spins several items should be carefully considered to assure a safe flight. No spins should be attempted without first having received dual instruction both in spin entries and spin recoveries from a qualified instructor who is familiar with the spin characteristics of the Cessna 172R.

The cabin should be clean and all loose equipment (including the microphone and rear seat belts) should be stowed or secured. For a solo flight in which spins will be conducted, the copilot's seat belt and shoulder harness should also be secured. Care should be taken to ensure that the pilot can easily reach the flight controls and produce maximum control travels.

It is recommended that, where feasible, entries be accomplished at high enough altitude that recoveries are completed 4000 feet or more above ground level. At least 1000 feet of altitude loss should be allowed for a 1-turn spin and recovery, while a 6-turn spin and recovery may require somewhat more than twice that amount. For example, the recommended entry altitude for a 6-turn spin would be 6000 feet above ground level. In any case, entries should be planned so that recoveries are completed well above the minimum 1500 feet above ground level required by FAR 91.303. Another reason for using high altitudes for practicing spins is that a greater field of view is provided which will assist in maintaining pilot orientation.

The normal entry is made from a power off stall. As the stall is approached, the elevator control should be smoothly pulled to the full aft position. Just prior to reaching the stall "break", rudder control in the desired direction of the spin rotation should be applied so that full rudder deflection is reached almost simultaneously with reaching full aft elevator. A slightly greater rate of deceleration than for normal stall entries, application of ailerons in the direction of the desired spin, and the use of power at the entry will assure more consistent and positive entries to the spin. As the airplane begins to spin, reduce the power to idle and return the ailerons to neutral. Both elevator and rudder controls should be held full with the spin until the spin recovery is initiated. An inadvertent relaxation of either of these controls could result in the development of a nose down spiral.

For the purpose of training in spins and spin recoveries, a 1 or 2 turn spin is adequate and should be used. Up to 2 turns, the spin will progress to a fairly rapid rate of rotation and a steep attitude. Application of recovery controls will produce prompt recoveries (within 1/4 turn). During extended spins of two to three turns or more, the spin will tend to change into a spiral, particularly to the right. This will be accompanied by an increase in airspeed and gravity loads on the airplane. If this occurs, recovery should be accomplished promptly but smoothly by leveling the wings and recovering from the resulting dive.

Regardless of how many turns the spin is held or how it is entered, the following recovery technique should be used:

1. VERIFY THAT THROTTLE IS IN IDLE POSITION AND AILERONS ARE NEUTRAL.
2. APPLY AND **HOLD** FULL RUDDER OPPOSITE TO THE DIRECTION OF ROTATION.
3. JUST **AFTER** THE RUDDER REACHES THE STOP, MOVE THE CONTROL WHEEL **BRISKLY** FORWARD FAR ENOUGH TO BREAK THE STALL.
4. **HOLD** THESE CONTROL INPUTS UNTIL ROTATION STOPS.
5. AS ROTATION STOPS, NEUTRALIZE RUDDER, AND MAKE A SMOOTH RECOVERY FROM THE RESULTING DIVE.

NOTE

If disorientation precludes a visual determination of the direction of rotation, the symbolic airplane in the turn coordinator may be referred to for this information.

Variations in basic airplane rigging or in weight and balance due to installed equipment or right seat occupancy can cause differences in behavior, particularly in extended spins. These differences are normal and will result in variations in the spin characteristics and in the spiraling tendencies for spins of more than 2 turns. However, the recovery technique should always be used and will result in the most expeditious recovery from any spin.

Intentional spins with flaps extended are prohibited, since the high speeds which may occur during recovery are potentially damaging to the flap/wing structure.

LANDING

NORMAL LANDING

Normal landing approaches can be made with power on or power off with any flap setting desired. Surface winds and air turbulence are usually the primary factors in determining the most comfortable approach speeds. Steep slips should be avoided with flap settings greater than 20° due to a slight tendency for the elevator to oscillate under certain combinations of airspeed, sideslip angle, and center of gravity loadings.

Actual touchdown should be made with power off and on the main wheels first to reduce the landing speed and subsequent need for braking in the landing roll. The nose wheel is lowered to the runway gently after the speed has diminished to avoid unnecessary nose gear loads. This procedure is especially important in rough or soft field landings.

SHORT FIELD LANDING

 For a short field landing in smooth air conditions, make an approach at 62 KIAS with 30° flaps using enough power to control the glide path. (Slightly higher approach speeds should be used under turbulent air conditions.) After all approach obstacles are cleared, progressively reduce power and maintain the approach speed by lowering the nose of the airplane. Touchdown should be made with power off and on the main wheels first. Immediately after touchdown, lower the nose wheel and apply heavy braking as required. For maximum brake effectiveness, retract the flaps, hold the control wheel full back, and apply maximum brake pressure without sliding the tires.

CROSSWIND LANDING

When landing in a strong crosswind, use the minimum flap setting required for the field length. If flap settings greater than 20° are used in sideslips with full rudder deflection, some elevator oscillation may be felt at normal approach speeds. However, this does not affect control of the airplane. Although the crab or combination method of drift correction may be used, the wing low method gives the best control. After touchdown, hold a straight course with the steerable nose wheel and occasional braking if necessary.

The maximum allowable crosswind velocity is dependent upon pilot capability as well as airplane limitations. Operation in direct crosswinds of 15 knots has been demonstrated.

BALKED LANDING

In a balked landing (go-around) climb, reduce the flap setting to 20° immediately after full power is applied. If obstacles must be cleared during the go-around climb, reduce the wing flap setting to 10° and maintain a safe airspeed until the obstacles are cleared. Above 3000 feet, lean the mixture to obtain maximum RPM. After clearing any obstacles, the flaps may be retracted as the airplane accelerates to the normal flaps up climb speed.

COLD WEATHER OPERATION

Special consideration should be given to the operation of the airplane fuel system during the winter season or prior to any flight in cold temperatures. Proper preflight draining of the fuel system is especially important and will eliminate any free water accumulation. The use of additives such as isopropyl alcohol or diethylene glycol monomethyl ether may also be desirable. Refer to Section 8 for information on the proper use of additives.

Cold weather often causes conditions which require special care during airplane operations. Even small accumulations of frost, ice, or snow must be removed, particularly from wing, tail and all control surfaces to assure satisfactory flight performance and handling. Also, control surfaces must be free of any internal accumulations of ice or snow.

If snow or slush covers the takeoff surface, allowance must be made for takeoff distances which will be increasingly extended as the snow or slush depth increases. The depth and consistency of this cover can, in fact, prevent takeoff in many instances.

WARNING

WHEN PULLING THE PROPELLER THROUGH BY HAND, TREAT IT AS IF THE IGNITION SWITCH IS TURNED ON. A LOOSE OR BROKEN GROUND WIRE ON EITHER MAGNETO COULD CAUSE THE ENGINE TO FIRE.

Prior to starting on cold mornings, it is advisable to pull the propeller through several times by hand to "break loose" or "limber" the oil, thus conserving battery energy.

When air temperatures are below 20°F (-6°C), the use of an external preheater and an external power source are recommended whenever possible to obtain positive starting and to reduce wear and abuse to the engine and electrical system. Preheat will thaw the oil trapped in the oil cooler, which probably will be congealed prior to starting in extremely cold temperatures.

When using an external power source, the master switch must be in the OFF position before connecting the external power source to the airplane receptacle. See Section 7, Ground Service Plug Receptacle for external power source operations.

Cold weather starting procedures are the same as the normal starting procedures. Use caution to prevent inadvertent forward movement of the airplane during starting when parked on snow or ice.

NOTE

If the engine does not start during the first few attempts, or if engine firing diminishes in strength, it is probable that the spark plugs have been frosted over. Preheat must be used before another start is attempted.

During cold weather operations, no indication will be apparent on the oil temperature gage prior to takeoff if outside air temperatures are very cold. After a suitable warm up period (2 to 5 minutes at 1000 RPM), accelerate the engine several times to higher engine RPM. If the engine accelerates smoothly and the oil pressure remains normal and steady, the airplane is ready for takeoff.

WINTERIZATION KIT

A winterization kit is provided and may be utilized when cold weather operations are conducted.

HOT WEATHER OPERATION

Refer to the general warm temperature starting information under Starting Engine in this section. Avoid prolonged engine operation on the ground.

NOISE CHARACTERISTICS AND NOISE REDUCTION

The certificated noise level for the Model 172R at 2450 pounds maximum weight is 73.3 dB(A). No determination has been made by the Federal Aviation Administration that the noise levels of this airplane are or should be acceptable or unacceptable for operation at, into, or out of, any airport.

The following procedures are suggested to minimize the effect of airplane noise on the public:

1. Pilots operating airplanes under VFR over outdoor assemblies of persons, recreational and park areas, and other noise sensitive areas should make every effort to fly not less than 2000 feet above the surface, weather permitting, even though flight at a lower level may be consistent with the provisions of government regulations.
2. During departure from or approach to an airport, climb after takeoff and descent for landing should be made so as to avoid prolonged flight at low altitude near noise sensitive areas.

NOTE

The above recommended procedures do not apply where they would conflict with Air Traffic Control clearances or instructions, or where, in the pilot's judgment, an altitude of less than 2000 feet is necessary to adequately exercise the duty to see and avoid other airplanes.

SECTION 5 PERFORMANCE

TABLE OF CONTENTS

Page

| | |
|---|------|
| Introduction | 5-3 |
| Use of Performance Charts | 5-3 |
| Sample Problem | 5-3 |
| Takeoff | 5-4 |
| Cruise | 5-5 |
| Fuel Required | 5-6 |
| Landing | 5-8 |
| Demonstrated Operating Temperature | 5-8 |
| Figure 5-1, Airspeed Calibration - Normal Static Source | 5-9 |
| Airspeed Calibration - Alternate Static Source | 5-10 |
| Figure 5-2, Temperature Conversion Chart | 5-11 |
| Figure 5-3, Stall Speeds | 5-12 |
| Figure 5-4, Crosswind Components | 5-13 |
| Figure 5-5, Short Field Takeoff Distance | 5-14 |
| Figure 5-6, Maximum Rate Of Climb | 5-15 |
| Figure 5-7, Time, Fuel, And Distance To Climb | 5-16 |
| Figure 5-8, Cruise Performance | 5-17 |
| Figure 5-9, Range Profile | 5-19 |
| Figure 5-10, Endurance Profile | 5-20 |
| Figure 5-11, Short Field Landing Distance | 5-21 |

INTRODUCTION

Performance data charts on the following pages are presented so that you may know what to expect from the airplane under various conditions, and also, to facilitate the planning of flights in detail and with reasonable accuracy. The data in the charts has been computed from actual flight tests with the airplane and engine in good condition and approximating average piloting techniques.

It should be noted that performance information presented in the range and endurance profile charts allows for 45 minutes reserve fuel at the specified power setting. Fuel flow data for cruise is based on the recommended lean mixture setting at all altitudes. Some indeterminate variables such as mixture leaning technique, fuel metering characteristics, engine and propeller condition, and air turbulence may account for variations of 10% or more in range and endurance. Therefore, it is important to utilize all available information to estimate the fuel required for the particular flight and to flight plan in a conservative manner.

USE OF PERFORMANCE CHARTS

Performance data is presented in tabular or graphical form to illustrate the effect of different variables. Sufficiently detailed information is provided in the tables so that conservative values can be selected and used to determine the particular performance figure with reasonable accuracy.

SAMPLE PROBLEM

The following sample flight problem utilizes information from the various charts to determine the predicted performance data for a typical flight. Assume the following information has already been determined:

AIRPLANE CONFIGURATION:

| | |
|----------------|-------------|
| Takeoff weight | 2450 Pounds |
| Usable fuel | 53 Gallons |

TAKEOFF CONDITIONS:

| | |
|-----------------------------|----------------------------|
| Field pressure altitude | 1500 Feet |
| Temperature | 28°C (16°C Above Standard) |
| Wind component along runway | 12 Knot Headwind |
| Field length | 3500 Feet |

SECTION 5
PERFORMANCE

CESSNA
MODEL 172R

CRUISE CONDITIONS:

| | |
|-----------------------|--------------------|
| Total distance | 320 Nautical Miles |
| Pressure altitude | 5500 Feet |
| Temperature | 20°C |
| Expected wind enroute | 10 Knot Headwind |

LANDING CONDITIONS:

| | |
|-------------------------|-----------|
| Field pressure altitude | 2000 Feet |
| Temperature | 25°C |
| Field length | 3000 Feet |

TAKEOFF

The takeoff distance chart, Figure 5-5, should be consulted, keeping in mind that distances shown are based on the short field technique. Conservative distances can be established by reading the chart at the next higher value of weight, altitude and temperature. For example, in this particular sample problem, the takeoff distance information presented for a weight of 2450 pounds, pressure altitude of 2000 feet and a temperature of 30°C should be used and results in the following:

| | |
|--|-----------|
| Ground roll | 1275 Feet |
| Total distance to clear a 50-foot obstacle | 2290 Feet |

These distances are well within the available takeoff field length. However, a correction for the effect of wind may be made based on Note 3 of the takeoff chart. The correction for a 12 knot headwind is:

$$\frac{12 \text{ Knots}}{9 \text{ Knots}} \times 10\% = 13\% \text{ Decrease}$$

This results in the following distances, corrected for wind:

| | |
|--|-------------|
| Ground roll, zero wind | 1275 |
| Decrease in ground roll (1275 feet X 13%) | <u>-166</u> |
| Corrected ground roll | 1109 Feet |

CESSNA
MODEL 172R

SECTION 5
PERFORMANCE

| | |
|--|-------------|
| Total distance to clear a 50-foot obstacle, zero wind | 2290 |
| Decrease in total distance (2290 feet X 13%) | <u>-298</u> |
| Corrected total distance to clear 50-foot obstacle | 1992 Feet |

CRUISE

The cruising altitude should be selected based on a consideration of trip length, winds aloft, and the airplane's performance. A typical cruising altitude and the expected wind enroute have been given for this sample problem. However, the power setting selection for cruise must be determined based on several considerations. These include the cruise performance characteristics presented in Figure 5-8, the range profile chart presented in Figure 5-9, and the endurance profile chart presented in Figure 5-10.

The relationship between power and range is illustrated by the range profile chart. Considerable fuel savings and longer range result when lower power settings are used. For this sample problem, a cruise power of approximately 65% will be used.

The cruise performance chart, Figure 5-8, is entered at 6000 feet pressure altitude and 20°C above standard temperature. These values most nearly correspond to the planned altitude and expected temperature conditions. The engine speed chosen is 2200 RPM, which results in the following:

| | |
|------------------|-----------|
| Power | 64% |
| True airspeed | 109 Knots |
| Cruise fuel flow | 7.3 GPH |

FUEL REQUIRED

The total fuel requirement for the flight may be estimated using the performance information in Figure 5-7 and Figure 5-8. For this sample problem, Figure 5-7 shows that a climb from 2000 feet to 6000 feet requires 1.4 gallons of fuel. The corresponding distance during the climb is 10 nautical miles. These values are for a standard temperature and are sufficiently accurate for most flight planning purposes. However, a further correction for the effect of temperature may be made as noted on the climb chart. The approximate effect of a non-standard temperature is to increase the time, fuel, and distance by 10% for each 10°C above standard temperature, due to the lower rate of climb. In this case, assuming a temperature 16°C above standard (28°C - 12°C), the correction would be:

$$\frac{16^{\circ}\text{C}}{10^{\circ}\text{C}} \times 10\% = 16\% \text{ Increase}$$

With this factor included, the fuel **estimate** would be calculated as follows:

| | |
|---|--------------------|
| Fuel to climb, standard temperature | 1.4 |
| Increase due to non-standard temperature (1.4 X 16%) | <u>0.2</u> |
| Corrected fuel to climb | 1.6 Gallons |

Using a similar procedure for the distance to climb results in 12 nautical miles. (10 nm using chart + 1.2 nm to correct for higher than standard temperature = 11.2 nm. Rounded up to 12 nm.)

CESSNA
MODEL 172R

SECTION 5
PERFORMANCE

The resultant cruise distance is:

| | |
|-----------------|------------|
| Total distance | 320 |
| Climb distance | <u>-12</u> |
| Cruise distance | 308 nm |

With an expected 10 knot headwind, the ground speed for cruise is predicted to be:

| |
|------------|
| 109 |
| <u>-10</u> |
| 99 Knots |

Therefore, the time required for the cruise portion of the trip is:

$$\frac{308 \text{ Nautical Miles}}{99 \text{ Knots}} = 3.1 \text{ Hours}$$

The fuel required for cruise is:

$$3.1 \text{ hours} \times 7.3 \text{ gallons/hour} = 22.7 \text{ Gallons}$$

A 45-minute reserve requires:

$$\frac{45}{60} \times 7.3 \text{ gallons / hour} = 5.5 \text{ Gallons}$$

The total estimated fuel required is as follows:

| | |
|---------------------------------|--------------|
| Engine start, taxi, and takeoff | 1.1 |
| Climb | 1.6 |
| Cruise | 22.7 |
| Reserve | <u>5.5</u> |
| Total fuel required | 30.9 Gallons |

Once the flight is underway, ground speed checks will provide a more accurate basis for estimating the time enroute and the corresponding fuel required to complete the trip with ample reserve.

LANDING

A procedure similar to takeoff should be used for estimating the landing distance at the destination airport. Figure 5-11 presents landing distance information for the short field technique. The distances corresponding to 2000 feet and 30°C are as follows:

| | |
|--|-----------|
| Ground roll | 625 Feet |
| Total distance to clear a 50-foot obstacle | 1410 Feet |

A correction for the effect of wind may be made based on Note 2 of the landing chart, using the same procedure as outlined for takeoff.

DEMONSTRATED OPERATING TEMPERATURE

Satisfactory engine cooling has been demonstrated for this airplane with an outside air temperature 23°C above standard. This is not to be considered as an operating limitation. Reference should be made to Section 2 for engine operating limitations.

AIRSPEED CALIBRATION



NORMAL STATIC SOURCE

CONDITION:

Power required for level flight or maximum rated RPM dive.

| | | | | | | | | | | | | | | | | | | | | | | | |
|----------------------|----|----|----|----|----|-----|-------|-------|-------|-------|-------|-------|-------|-------|-------|-------|-------|-------|-------|-------|-------|-------|-------|
| FLAPS UP | | | | | | | | | | | | | | | | | | | | | | | |
| CIAS | 50 | 60 | 70 | 80 | 90 | 100 | 110 | 120 | 130 | 140 | 150 | 160 | | | | | | | | | | | |
| KCAS | 56 | 62 | 70 | 79 | 89 | 98 | 107 | 117 | 126 | 135 | 145 | 154 | | | | | | | | | | | |
| FLAPS 10° | | | | | | | | | | | | | | | | | | | | | | | |
| CIAS | 40 | 50 | 60 | 70 | 80 | 90 | 100 | 110 | ----- | ----- | ----- | ----- | ----- | ----- | ----- | ----- | ----- | ----- | ----- | ----- | ----- | ----- | ----- |
| KCAS | 49 | 55 | 62 | 70 | 79 | 89 | 98 | 108 | ----- | ----- | ----- | ----- | ----- | ----- | ----- | ----- | ----- | ----- | ----- | ----- | ----- | ----- | ----- |
| FLAPS 30° | | | | | | | | | | | | | | | | | | | | | | | |
| CIAS | 40 | 50 | 60 | 70 | 80 | 85 | ----- | ----- | ----- | ----- | ----- | ----- | ----- | ----- | ----- | ----- | ----- | ----- | ----- | ----- | ----- | ----- | ----- |
| KCAS | 47 | 53 | 61 | 70 | 80 | 84 | ----- | ----- | ----- | ----- | ----- | ----- | ----- | ----- | ----- | ----- | ----- | ----- | ----- | ----- | ----- | ----- | ----- |

Figure 5-1. Airspeed Calibration (Sheet 1 of 2)



**AIRSPPEED CALIBRATION
ALTERNATE STATIC SOURCE**

HEATER OFF, VENTS AND WINDOWS CLOSED

| | | | | | | | | | | | | |
|------------------|----|----|----|----|----|-----|-----|-----|-----|-----|-----|-----|
| FLAPS UP | | | | | | | | | | | | |
| NORMAL KIAS | 50 | 60 | 70 | 80 | 90 | 100 | 110 | 120 | 130 | 140 | --- | --- |
| ALTERNATE KIAS | 51 | 61 | 71 | 82 | 91 | 101 | 111 | 121 | 131 | 141 | --- | --- |
| FLAPS 10° | | | | | | | | | | | | |
| NORMAL KIAS | 40 | 50 | 60 | 70 | 80 | 90 | 100 | 110 | --- | --- | --- | --- |
| ALTERNATE KIAS | 40 | 51 | 61 | 71 | 81 | 90 | 99 | 108 | --- | --- | --- | --- |
| FLAPS 30° | | | | | | | | | | | | |
| NORMAL KIAS | 40 | 50 | 60 | 70 | 80 | 85 | --- | --- | --- | --- | --- | --- |
| ALTERNATE KIAS | 38 | 50 | 60 | 70 | 79 | 81 | --- | --- | --- | --- | --- | --- |

HEATER ON, VENTS OPEN AND WINDOWS CLOSED

| | | | | | | | | | | | | |
|------------------|----|----|----|----|----|----|-----|-----|-----|-----|-----|-----|
| FLAPS UP | | | | | | | | | | | | |
| NORMAL KIAS | 40 | 50 | 60 | 70 | 80 | 90 | 100 | 110 | 120 | 130 | 140 | --- |
| ALTERNATE KIAS | 36 | 48 | 59 | 70 | 80 | 89 | 99 | 108 | 118 | 128 | 139 | --- |
| FLAPS 10° | | | | | | | | | | | | |
| NORMAL KIAS | 40 | 50 | 60 | 70 | 80 | 90 | 100 | 110 | --- | --- | --- | --- |
| ALTERNATE KIAS | 38 | 49 | 59 | 69 | 79 | 88 | 97 | 106 | --- | --- | --- | --- |
| FLAPS 30° | | | | | | | | | | | | |
| NORMAL KIAS | 40 | 50 | 60 | 70 | 80 | 85 | --- | --- | --- | --- | --- | --- |
| ALTERNATE KIAS | 34 | 47 | 57 | 67 | 77 | 81 | --- | --- | --- | --- | --- | --- |

WINDOWS OPEN

| | | | | | | | | | | | | |
|------------------|----|----|----|----|----|----|-----|-----|-----|-----|-----|-----|
| FLAPS UP | | | | | | | | | | | | |
| NORMAL KIAS | 40 | 50 | 60 | 70 | 80 | 90 | 100 | 110 | 120 | 130 | 140 | --- |
| ALTERNATE KIAS | 26 | 43 | 57 | 70 | 82 | 93 | 103 | 113 | 123 | 133 | 143 | --- |
| FLAPS 10° | | | | | | | | | | | | |
| NORMAL KIAS | 40 | 50 | 60 | 70 | 80 | 90 | 100 | 110 | --- | --- | --- | --- |
| ALTERNATE KIAS | 25 | 43 | 57 | 69 | 80 | 91 | 101 | 111 | --- | --- | --- | --- |
| FLAPS 30° | | | | | | | | | | | | |
| NORMAL KIAS | 40 | 50 | 60 | 70 | 80 | 85 | --- | --- | --- | --- | --- | --- |
| ALTERNATE KIAS | 25 | 41 | 54 | 67 | 78 | 84 | --- | --- | --- | --- | --- | --- |

Figure 5-1. Airspeed Calibration (Sheet 2 of 2)

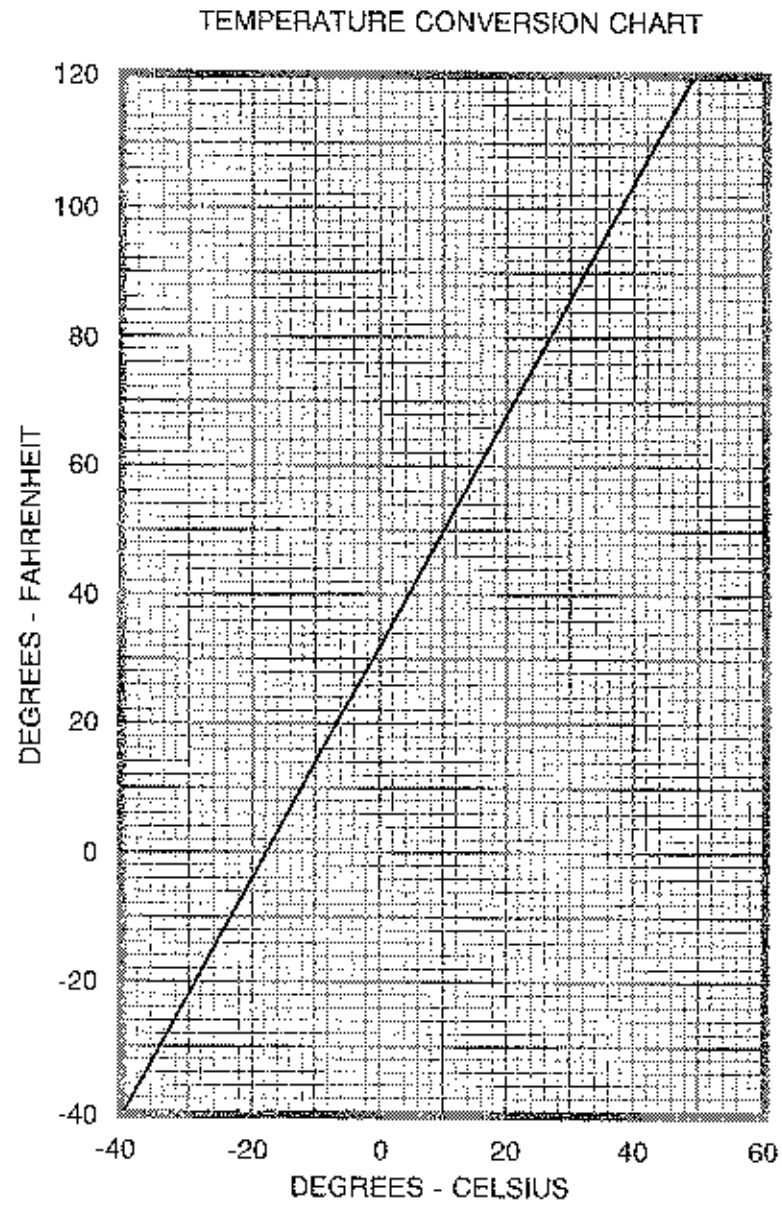

Figure 5-2. Temperature Conversion Chart



STALL SPEEDS AT 2450 POUNDS

Conditions:
Power Off

MOST REARWARD CENTER OF GRAVITY

| FLAP SETTING | ANGLE OF BANK | | | | | | | |
|-----------------|---------------|------|------|------|------|------|------|------|
| | 0° | | 30° | | 45° | | 60° | |
| | KIAS | KCAS | KIAS | KCAS | KIAS | KCAS | KIAS | KCAS |
| UP | 44 | 51 | 48 | 55 | 53 | 61 | 63 | 73 |
| 10° | 35 | 48 | 38 | 52 | 42 | 58 | 50 | 69 |
| 30° | 33 | 47 | 36 | 50 | 40 | 56 | 47 | 66 |

MOST FORWARD CENTER OF GRAVITY

| FLAP SETTING | ANGLE OF BANK | | | | | | | |
|-----------------|---------------|------|------|------|------|------|------|------|
| | 0° | | 30° | | 45° | | 60° | |
| | KIAS | KCAS | KIAS | KCAS | KIAS | KCAS | KIAS | KCAS |
| UP | 44 | 52 | 48 | 56 | 53 | 62 | 63 | 74 |
| 10° | 37 | 50 | 40 | 53 | 44 | 59 | 53 | 70 |
| 30° | 33 | 47 | 36 | 50 | 40 | 56 | 47 | 66 |

NOTES:

1. Altitude loss during a stall recovery may be as much as 230 feet.
2. KIAS values are approximate.

Figure 5-3. Stall Speeds

WIND COMPONENTS

NOTE:
Maximum demonstrated crosswind velocity is 15 knots (not a limitation).

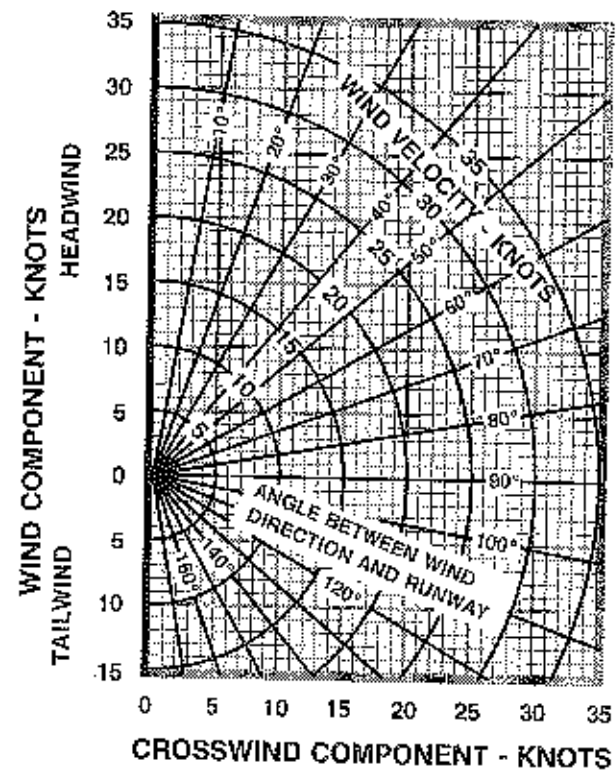

NOTE

Maximum demonstrated crosswind component is 15 knots (not a limitation).

0585C1009

Figure 5-4. Crosswind Components



**SHORT FIELD TAKEOFF DISTANCE
AT 2450 POUNDS**

CONDITIONS:

Flaps 10°
Full Throttle Prior to Brake Release
Paved, level, dry runway
Zero Wind
Lift Off: 54 KIAS
Speed at 50 ft: 57 KIAS

| Press Alt In Feet | 0°C | | 10°C | | 20°C | | 30°C | | 40°C | |
|----------------------------|--------------------|--|--------------------|--|--------------------|--|--------------------|--|--------------------|--|
| | Grnd Roll Ft | Total Ft To Clear 50 Ft Obst | Grnd Roll Ft | Total Ft To Clear 50 Ft Obst | Grnd Roll Ft | Total Ft To Clear 50 Ft Obst | Grnd Roll Ft | Total Ft To Clear 50 Ft Obst | Grnd Roll Ft | Total Ft To Clear 50 Ft Obst |
| S. L. | 845 | 1510 | 910 | 1625 | 980 | 1745 | 1055 | 1875 | 1135 | 2015 |
| 1000 | 925 | 1660 | 1000 | 1790 | 1075 | 1925 | 1160 | 2070 | 1245 | 2220 |
| 2000 | 1015 | 1830 | 1095 | 1970 | 1185 | 2125 | 1275 | 2290 | 1365 | 2455 |
| 3000 | 1115 | 2020 | 1205 | 2185 | 1305 | 2360 | 1400 | 2540 | 1505 | 2730 |
| 4000 | 1230 | 2245 | 1330 | 2430 | 1435 | 2630 | 1545 | 2830 | 1655 | 3045 |
| 5000 | 1355 | 2500 | 1470 | 2715 | 1585 | 2945 | 1705 | 3175 | 1830 | 3430 |
| 6000 | 1500 | 2805 | 1625 | 3060 | 1750 | 3315 | 1880 | 3590 | 2020 | 3895 |
| 7000 | 1660 | 3170 | 1795 | 3470 | 1935 | 3770 | 2085 | 4105 | 2240 | 4485 |
| 8000 | 1840 | 3620 | 1995 | 3975 | 2150 | 4345 | 2315 | 4775 | --- | --- |

NOTES:

1. Short field technique as specified in Section 4.
2. Prior to takeoff from fields above 3000 feet elevation, the mixture should be leaned to give maximum RPM in a full throttle, static runup.
3. Decrease distances 10% for each 9 knots headwind. For operation with tail winds up to 10 knots, increase distances by 10% for each 2 knots.
4. For operation on dry, grass runway, increase distances by 15% of the "ground roll" figure.
5. Where distance value has been deleted, climb performance is minimal.

Figure 5-5. Short Field Takeoff Distance

MAXIMUM RATE-OF-CLIMB AT 2450 POUNDS

CONDITIONS:
Flaps Up
Full Throttle

| PRESS ALT FT | CLIMB SPEED KIAS | RATE OF CLIMB - FPM | | | |
|--------------------|------------------------|---------------------|-----|------|------|
| | | -20°C | 0°C | 20°C | 40°C |
| S.L. | 79 | 830 | 770 | 705 | 640 |
| 2000 | 77 | 720 | 655 | 595 | 535 |
| 4000 | 76 | 645 | 585 | 525 | 465 |
| 6000 | 74 | 530 | 475 | 415 | 360 |
| 8000 | 72 | 420 | 365 | 310 | 250 |
| 10,000 | 71 | 310 | 255 | 200 | 145 |
| 12,000 | 69 | 200 | 145 | --- | --- |

NOTE:

1. Mixture leaned above 3000 feet for maximum RPM.

Figure 5-6. Maximum Rate of Climb

SECTION 5
PERFORMANCE

CESSNA
MODEL 172R

**TIME, FUEL AND DISTANCE TO CLIMB
AT 2450 POUNDS**

CONDITIONS:

Flaps Up
Full Throttle
Standard Temperature

| PRESS ALT FT | TEMP °C | CLIMB SPEED KIAS | RATE OF CLIMB FPM | FROM SEA LEVEL | | |
|--------------------|------------|------------------------|----------------------------|-------------------|---------------------|------------|
| | | | | TIME IN MIN | FUEL USED GAL | DIST NM |
| S.L. | 15 | 79 | 720 | 0 | 0.0 | 0 |
| 1000 | 13 | 78 | 670 | 1 | 0.4 | 2 |
| 2000 | 11 | 77 | 625 | 3 | 0.7 | 4 |
| 3000 | 9 | 76 | 575 | 5 | 1.2 | 6 |
| 4000 | 7 | 76 | 560 | 6 | 1.5 | 8 |
| 5000 | 5 | 75 | 515 | 8 | 1.8 | 11 |
| 6000 | 3 | 74 | 465 | 10 | 2.1 | 14 |
| 7000 | 1 | 73 | 415 | 13 | 2.5 | 17 |
| 8000 | -1 | 72 | 365 | 15 | 3.0 | 21 |
| 9000 | -3 | 72 | 315 | 18 | 3.4 | 25 |
| 10,000 | -5 | 71 | 270 | 22 | 4.0 | 29 |
| 11,000 | -7 | 70 | 220 | 26 | 4.6 | 35 |
| 12,000 | -9 | 69 | 170 | 31 | 5.4 | 43 |

NOTES:

1. Add 1.1-gallons of fuel for engine start, taxi and takeoff allowance.
2. Mixture leaned above 3000 feet for maximum RPM.
3. Increase time, fuel and distance by 10% for each 10°C above standard temperature.
4. Distances shown are based on zero wind.

Figure 5-7. Time, Fuel and Distance to Climb

CRUISE PERFORMANCE

CONDITIONS:
2450 Pounds
Recommended Lean Mixture At All Altitudes (Refer to Section 4,
Cruise)

| PRESS ALT FT | RPM | 20°C BELOW STANDARD TEMP | | | STANDARD TEMPERATURE | | | 20°C ABOVE STANDARD TEMP | | |
|--------------------|------|-----------------------------|------|-----|-------------------------|------|-----|-----------------------------|------|-----|
| | | % BHP | KTAS | GPH | % BHP | KTAS | GPH | % BHP | KTAS | GPH |
| 2000 | 2250 | --- | --- | --- | 79 | 115 | 9.0 | 74 | 114 | 8.5 |
| | 2200 | 79 | 112 | 9.1 | 74 | 112 | 8.5 | 70 | 111 | 8.0 |
| | 2100 | 69 | 107 | 7.9 | 65 | 106 | 7.5 | 62 | 105 | 7.1 |
| | 2000 | 61 | 101 | 7.0 | 58 | 99 | 6.6 | 55 | 97 | 6.4 |
| | 1900 | 54 | 94 | 6.2 | 51 | 91 | 5.9 | 50 | 89 | 5.8 |
| 4000 | 2300 | --- | --- | --- | 79 | 117 | 9.1 | 75 | 117 | 8.6 |
| | 2250 | 80 | 115 | 9.2 | 75 | 114 | 8.6 | 70 | 114 | 8.1 |
| | 2200 | 75 | 112 | 8.6 | 70 | 111 | 8.1 | 66 | 110 | 7.6 |
| | 2100 | 66 | 106 | 7.6 | 62 | 105 | 7.1 | 59 | 103 | 6.8 |
| | 2000 | 58 | 100 | 6.7 | 55 | 98 | 6.4 | 53 | 95 | 6.2 |
| | 1900 | 52 | 92 | 6.0 | 50 | 90 | 5.8 | 49 | 87 | 5.6 |
| 6000 | 2350 | --- | --- | --- | 80 | 120 | 9.2 | 75 | 119 | 8.6 |
| | 2300 | 80 | 117 | 9.2 | 75 | 117 | 8.6 | 71 | 116 | 8.1 |
| | 2250 | 76 | 115 | 8.7 | 71 | 114 | 8.1 | 67 | 113 | 7.7 |
| | 2200 | 71 | 112 | 8.1 | 67 | 111 | 7.7 | 64 | 109 | 7.3 |
| | 2100 | 63 | 105 | 7.2 | 60 | 104 | 6.9 | 57 | 101 | 6.6 |
| | 2000 | 56 | 98 | 6.4 | 53 | 96 | 6.2 | 52 | 93 | 6.0 |

NOTE:

1. Cruise speeds are shown for an airplane equipped with speed fairings. Without speed fairings, decrease speeds shown by 2 knots.

Figure 5-8. Cruise Performance (Sheet 1 of 2)



CRUISE PERFORMANCE

CONDITIONS:
2450 Pounds
Recommended Lean Mixture At All Altitudes (Refer to Section 4,
Cruise)

| PRESS ALT FT | RPM | 20°C BELOW STANDARD TEMP | | | STANDARD TEMPERATURE | | | 20°C ABOVE STANDARD TEMP | | |
|--------------------|------|-----------------------------|------|-----|-------------------------|------|-----|-----------------------------|------|-----|
| | | % BHP | KTAS | GPH | % BHP | KTAS | GPH | % BHP | KTAS | GPH |
| 8000 | 2400 | -- | --- | --- | 80 | 122 | 9.2 | 76 | 121 | 8.7 |
| | 2350 | 81 | 120 | 9.3 | 76 | 119 | 8.7 | 71 | 118 | 8.2 |
| | 2300 | 76 | 117 | 8.7 | 71 | 116 | 8.2 | 68 | 115 | 7.8 |
| | 2200 | 68 | 111 | 7.7 | 64 | 110 | 7.3 | 61 | 107 | 7.0 |
| | 2100 | 60 | 104 | 6.9 | 57 | 102 | 6.6 | 55 | 99 | 6.4 |
| | 2000 | 54 | 96 | 6.2 | 52 | 94 | 6.0 | 51 | 91 | 5.9 |
| 10,000 | 2350 | 76 | 119 | 8.8 | 72 | 118 | 8.2 | 68 | 117 | 7.8 |
| | 2300 | 72 | 116 | 8.3 | 68 | 115 | 7.8 | 65 | 113 | 7.4 |
| | 2250 | 68 | 113 | 7.8 | 65 | 112 | 7.4 | 61 | 109 | 7.1 |
| | 2200 | 65 | 110 | 7.4 | 61 | 108 | 7.0 | 59 | 105 | 6.7 |
| | 2100 | 58 | 102 | 6.6 | 55 | 100 | 6.4 | 54 | 97 | 6.2 |
| | 2000 | 52 | 94 | 6.1 | 51 | 91 | 5.9 | 50 | 88 | 5.8 |
| 12,000 | 2350 | 73 | 119 | 8.3 | 69 | 117 | 7.9 | 65 | 115 | 7.5 |
| | 2300 | 69 | 115 | 7.9 | 65 | 113 | 7.5 | 62 | 111 | 7.1 |
| | 2250 | 65 | 112 | 7.5 | 62 | 109 | 7.1 | 59 | 107 | 6.8 |
| | 2200 | 62 | 108 | 7.1 | 59 | 105 | 6.8 | 57 | 103 | 6.6 |
| | 2100 | 56 | 100 | 6.4 | 54 | 97 | 6.2 | 53 | 94 | 6.1 |

NOTE:

1. Cruise speeds are shown for an airplane equipped with speed fairings. Without speed fairings, decrease speeds shown by 2 knots.

Figure 5-8. Cruise Performance (Sheet 2 of 2)

RANGE PROFILE
45 MINUTES RESERVE
53 GALLONS USABLE FUEL

CONDITIONS:
2450 Pounds
Recommended Lean Mixture for Cruise At All Altitudes
Standard Temperature
Zero Wind

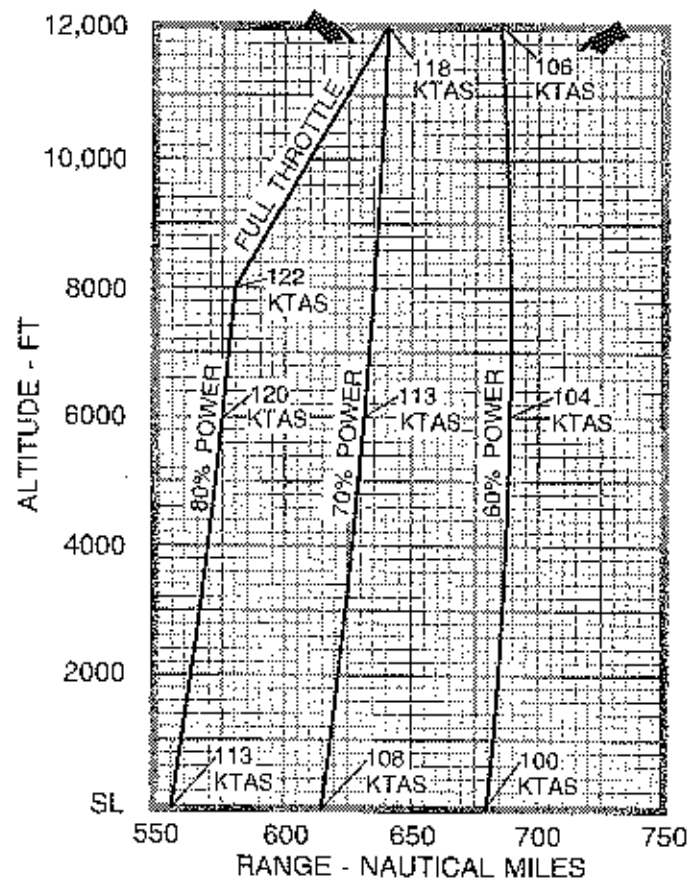

NOTES:

1. This chart allows for the fuel used for engine start, taxi, takeoff and climb, and the distance during climb.
2. Performance is shown for an airplane equipped with speed fairings, which increase the cruise speeds by approximately two knots.

Figure 5-9. Range Profile



ENDURANCE PROFILE
45 MINUTES RESERVE
53 GALLONS USABLE FUEL

CONDITIONS:
2450 Pounds
Recommended Lean Mixture for Cruise At All Altitudes
Standard Temperature

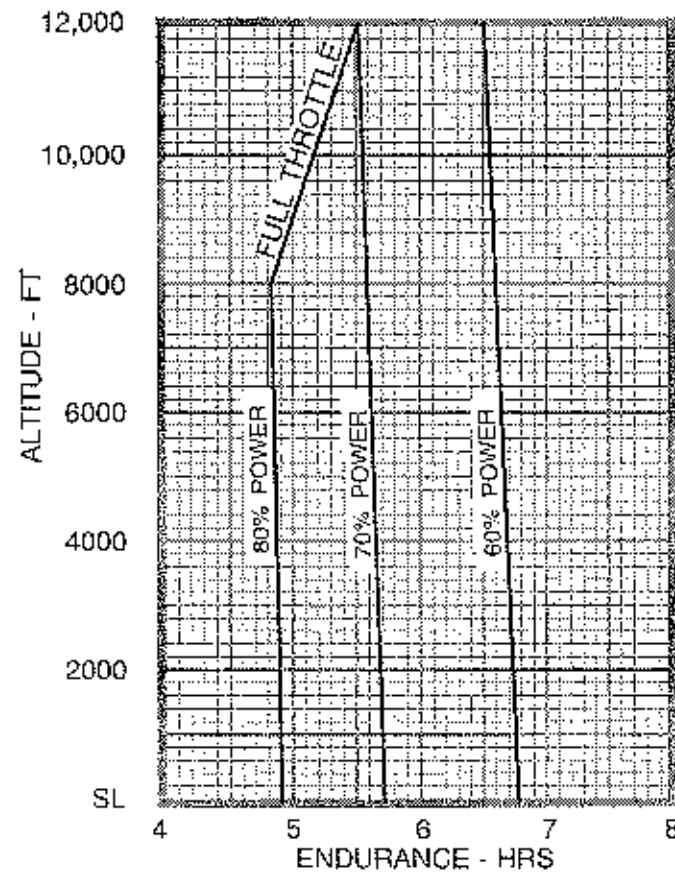

NOTE:

1. This chart allows for the fuel used for engine start, taxi, takeoff and climb, and the time during climb.



Figure 5-10. Endurance Profile

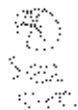

**SHORT FIELD LANDING DISTANCE
AT 2450 POUNDS**

CONDITIONS:

Flaps 30°
Power Off
Maximum Braking
Paved, level, dry runway
Zero Wind
Speed at 50 Ft: 62 KIAS

| Press Alt In Feet | 0°C | | 10°C | | 20°C | | 30°C | | 40°C | |
|-------------------|--------------|------------------------------|--------------|------------------------------|--------------|------------------------------|--------------|------------------------------|--------------|------------------------------|
| | Grnd Roll Ft | Total Ft To Clear 50 Ft Obst | Grnd Roll Ft | Total Ft To Clear 50 Ft Obst | Grnd Roll Ft | Total Ft To Clear 50 Ft Obst | Grnd Roll Ft | Total Ft To Clear 50 Ft Obst | Grnd Roll Ft | Total Ft To Clear 50 Ft Obst |
| S. L. | 525 | 1250 | 540 | 1280 | 560 | 1310 | 580 | 1340 | 600 | 1370 |
| 1000 | 545 | 1280 | 560 | 1310 | 580 | 1345 | 600 | 1375 | 620 | 1405 |
| 2000 | 565 | 1310 | 585 | 1345 | 605 | 1375 | 625 | 1410 | 645 | 1440 |
| 3000 | 585 | 1345 | 605 | 1380 | 625 | 1415 | 650 | 1445 | 670 | 1480 |
| 4000 | 605 | 1380 | 630 | 1415 | 650 | 1450 | 670 | 1485 | 695 | 1520 |
| 5000 | 630 | 1415 | 650 | 1455 | 675 | 1490 | 700 | 1525 | 720 | 1560 |
| 6000 | 655 | 1455 | 675 | 1490 | 700 | 1530 | 725 | 1565 | 750 | 1605 |
| 7000 | 680 | 1495 | 705 | 1535 | 730 | 1570 | 755 | 1610 | 775 | 1650 |
| 8000 | 705 | 1535 | 730 | 1575 | 755 | 1615 | 780 | 1655 | 810 | 1695 |

NOTES:

1. Short field technique as specified in Section 4.
2. Decrease distances 10% for each 9 knots headwind. For operation with tail winds up to 10 knots, increase distances by 10% for each 2 knots.
3. For operation on dry, grass runway, increase distances by 45% of the "ground roll" figure.
4. If landing with flaps up, increase the approach speed by 7 KIAS and allow for 35% longer distances.

Figure 5-11. Short Field Landing Distance

WEIGHT & BALANCE/
EQUIPMENT LIST



SECTION 6 WEIGHT & BALANCE/ EQUIPMENT LIST

| TABLE OF CONTENTS | Page |
|------------------------------------|------|
| Introduction | 6-3 |
| Airplane Weighing Procedures | 6-3 |
| Weight And Balance | 6-6 |
| Baggage Tie-Down | 6-8 |
| Comprehensive Equipment List | 6-17 |

.....

.....

INTRODUCTION

This section describes the procedure for establishing the basic empty weight and moment of the airplane. Sample forms are provided for reference. Procedures for calculating the weight and moment for various operations are also provided. A comprehensive list of all Cessna equipment available for this airplane is included at the back of this section.

It should be noted that specific information regarding the weight, arm, moment and installed equipment for this airplane as delivered from the factory can only be found in the plastic envelope carried in the back of this handbook.

WARNING

IT IS THE RESPONSIBILITY OF THE PILOT TO ENSURE THE AIRPLANE IS LOADED PROPERLY. OPERATION OUTSIDE OF PRESCRIBED WEIGHT AND BALANCE LIMITATIONS COULD RESULT IN AN ACCIDENT AND SERIOUS OR FATAL INJURY.

AIRPLANE WEIGHING PROCEDURES

1. Preparation:
 - a. Inflate tires to recommended operating pressures.
 - b. Defuel airplane. Refer to the Maintenance Manual.
 - c. Service engine oil as required to obtain a normal full indication (8 quarts on dipstick).
 - d. Move sliding seats to the most forward position.
 - e. Raise flaps to the fully retracted position.
 - f. Place all control surfaces in neutral position.
 - g. Remove all non-required items from airplane.
2. Leveling:
 - a. Place scales under each wheel (minimum scale capacity, 500-pounds nose, 1000 pounds each main).
 - b. Deflate the nose tire and/or lower or raise the nose strut to properly center the bubble in the level (Refer to Figure 6-1).

AIRPLANE WEIGHING FORM

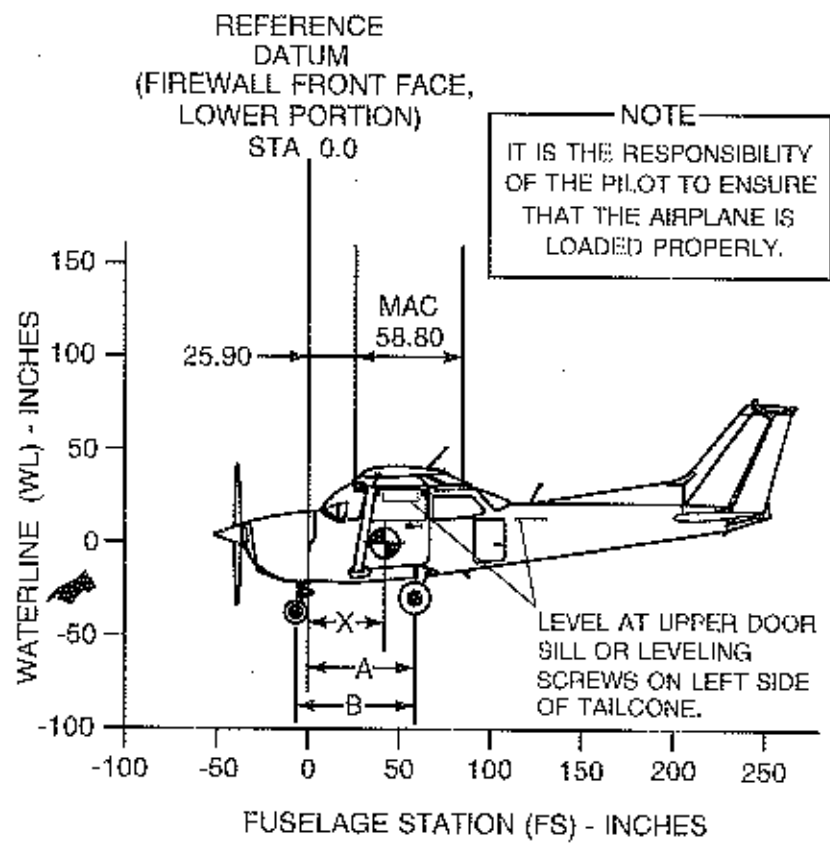

0585C101G

Figure 6-1. Airplane Weighing Form (Sheet 1 of 2)

LOCATING CG WITH AIRPLANE ON LANDING GEAR

FORMULA for Longitudinal CG:

$$(X) = (A) \frac{(\text{NOSE GEAR NET WEIGHT}) (B)}{\text{NOSE AND MAIN LANDING GEAR WEIGHT TOTAL}} = (C) \text{ INCHES AFT OF DATUM}$$

MEASURING A AND B

MEASURE A AND B PER PILOT'S OPERATING HANDBOOK INSTRUCTIONS TO ASSIST IN LOCATING CG WITH AIRPLANE WEIGHED ON LANDING GEAR.

LOCATING PERCENT MAC

FORMULA for Percent MAC:

$$\text{CG Percent MAC} = \frac{(\text{CG Arm of Airplane}) - 25.30}{0.5000}$$

LEVELING PROVISIONS

LONGITUDINAL - LEFT SIDE OF TAILCONE AT FS 108.00 & 142.00

AIRPLANE AS WEIGHED TABLE

| POSITION | SCALE READING | SCALE DRIFT | TARE | NET WEIGHT |
|---------------------------|---------------|-------------|------|------------|
| LEFT SIDE | | | | |
| RIGHT SIDE | | | | |
| NOSE | | | | |
| AIRPLANE TOTAL AS WEIGHED | | | | |

BASIC EMPTY WEIGHT AND CENTER-OF-GRAVITY TABLE

| ITEM | WEIGHT POUNDS | CG ARM (INCHES) | MOMENT (INCH-POUNDS /1000) |
|--|---------------|-----------------|----------------------------|
| AIRPLANE (CALCULATED OR AS WEIGHED) (INCLUDES ALL UNDRAINABLE FLUIDS AND FULL OIL) | | | |
| DRAINABLE UNUSABLE FUEL AT 6.0 POUNDS PER GALLON - (3 GALLONS) | 18.0 | 46.0 | 0.87 |
| BASIC EMPTY WEIGHT | | | |

Figure 6-1. Airplane Weighing Form (Sheet 2 of 2)

3. Weighing:
 - a. Weigh airplane in a closed hangar to avoid errors caused by air currents.
 - b. With the airplane level and brakes released, record the weight shown on each scale. Deduct the tare, if any, from each reading.
4. Measuring:
 - a. Obtain measurement A by measuring horizontally (along the airplane centerline) from a line stretched between the main wheel centers to a plumb bob dropped from the firewall.
 - b. Obtain measurement B by measuring horizontally and parallel to the airplane centerline, from center of nose wheel axle, left side, to a plumb bob dropped from the line between the main wheel centers. Repeat on right side and average the measurements.
5. Using weights from item 3 and measurements from item 4, the airplane weight and C.G. can be determined.
6. Basic Empty Weight may be determined by completing Figure 6-1.

WEIGHT AND BALANCE

The following information will enable you to operate your Cessna within the prescribed weight and center of gravity limitations. To calculate weight and balance, use the Sample Loading Problem, Loading Graph, and Center of Gravity Moment Envelope as follows:

Take the basic empty weight and moment from appropriate weight and balance records carried in your airplane, and enter them in the column titled YOUR AIRPLANE on the Sample Loading Problem.

NOTE

In addition to the basic empty weight and moment noted on these records, the C.G. arm (fuselage station) is also shown, but need not be used on the Sample Loading Problem. The moment which is shown must be divided by 1000 and this value used as the moment/1000 on the loading problem.

Use the Loading Graph to determine the moment/1000 for each additional item to be carried; then list these on the loading problem.

SAMPLE WEIGHT AND BALANCE RECORD

(CONTINUOUS HISTORY OF CHANGES IN STRUCTURE OR EQUIPMENT AFFECTING WEIGHT AND BALANCE)

| DATE | AIRPLANE MODEL | | DESCRIPTION OF ARTICLE OR MODIFICATION | SERIAL NO. | | | | PAGE NUMBER | | | | | |
|------|----------------|-----|--|---------------|------------------------|--------------|------------------------|--------------|------------------------|----------------------------------|-------------------|--|--|
| | ITEM NO. | | | WEIGHT CHANGE | | ADDED (+) | | REMOVED (-) | | RUNNING BASIC EMPTY WEIGHT | | | |
| | IN | OUT | | WT. (LB.) | ARM MOMENT (IN.) | WT. (LB.) | ARM MOMENT (IN.) | WT. (LB.) | ARM MOMENT (IN.) | WT. (LB.) | MOMENT (/1000) | | |
| | | | AS DELIVERED | | | | | | | | | | |
| | | | | | | | | | | | | | |
| | | | | | | | | | | | | | |
| | | | | | | | | | | | | | |
| | | | | | | | | | | | | | |
| | | | | | | | | | | | | | |
| | | | | | | | | | | | | | |
| | | | | | | | | | | | | | |
| | | | | | | | | | | | | | |
| | | | | | | | | | | | | | |
| | | | | | | | | | | | | | |
| | | | | | | | | | | | | | |

0586C1008

Figure 6-2. Sample Weight and Balance Record

NOTE

Loading Graph information for the pilot, passengers and baggage is based on seats positioned for average occupants and baggage loaded in the center of the baggage areas as shown on the Loading Arrangements diagram. For loadings which may differ from these, the Sample Loading Problem lists fuselage stations for these items to indicate their forward and aft C.G. range limitations (seat travel and baggage area limitation). Additional moment calculations, based on the actual weight and C.G. arm (fuselage station) of the item being loaded, must be made if the position of the load is different from that shown on the Loading Graph.

Total the weights and moments/1000 and plot these values on the Center of Gravity Moment Envelope to determine whether the point falls within the envelope, and if the loading is acceptable.

BAGGAGE TIE-DOWN

A nylon baggage net having tie-down straps is provided as standard equipment to secure baggage on the cabin floor aft of the rear seat (baggage area 1) and in the aft baggage area (baggage area 2). Six eyebolts serve as attaching points for the net. Two eyebolts for the forward tie-down straps are mounted on the cabin floor near each sidewall just forward of the baggage door approximately at station 90; two eyebolts are installed on the cabin floor slightly inboard of each sidewall approximately at station 107; and two eyebolts are located below the aft window near each sidewall approximately at station 107. A placard on the baggage door defines the weight limitations in the baggage areas.

When baggage area 1 is utilized for baggage only, the two forward floor mounted eyebolts and the two aft floor mounted eyebolts (or the two eyebolts below the aft window) may be used, depending on the height of the baggage. When baggage is carried in the baggage area 2 only, the aft floor mounted eyebolts and the eyebolts below the aft window should be used. When baggage is loaded in both areas, all six eyebolts should be utilized.

LOADING ARRANGEMENTS

- * Pilot or passenger center of gravity on adjustable seats positioned for average occupant. Numbers in parentheses indicate forward and aft limits of occupant center of gravity range.
- ** Arm measured to the center of the areas shown.

- NOTES:**
1. The usable fuel C.G. arm for integral tanks is located at station 48.0.
 2. The rear cabin wall (approximate station 108) or aft baggage wall (approximate station 142) can be used as convenient interior reference points for determining the location of baggage area fuselage stations.

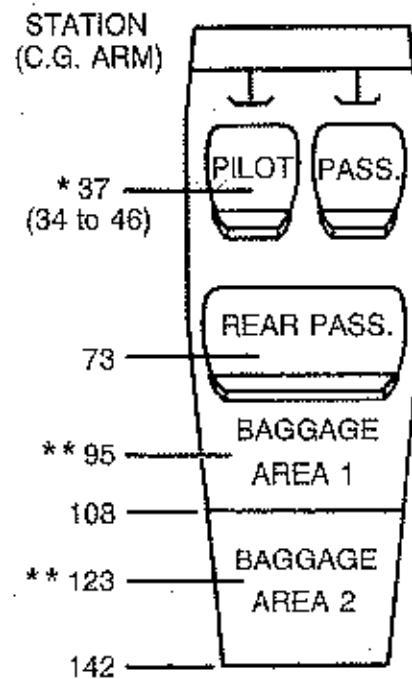

0586X1016

Figure 6-3. Loading Arrangements

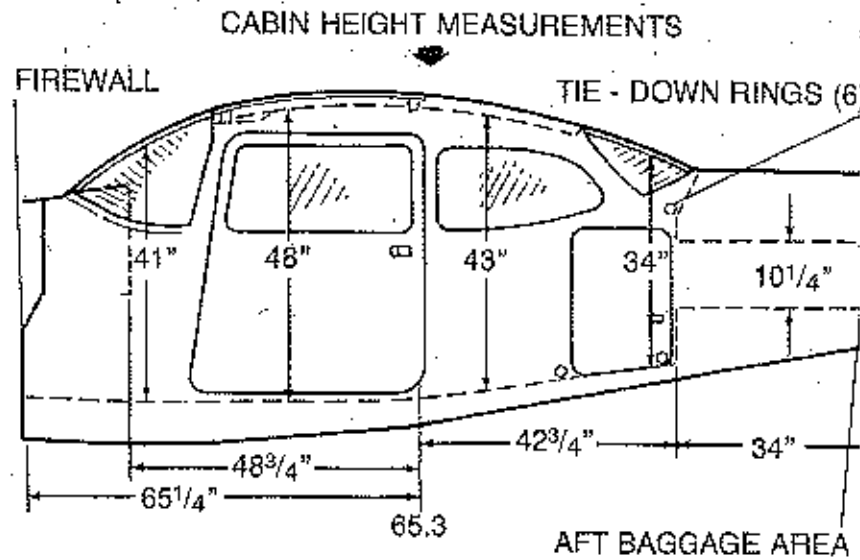

DOOR OPENING DIMENSIONS

| | WIDTH (TOP) | WIDTH (BOTTOM) | HEIGHT (FRONT) | HEIGHT (REAR) |
|--------------|----------------|-------------------|-------------------|------------------|
| CABIN DOORS | 32 1/2" | 37" | 40 1/2" | 39" |
| BAGGAGE DOOR | 15 1/4" | 15 1/4" | 22" | 21" |

0686X10

Figure 6-4. Internal Cabin Dimensions (Sheet 1 of 2)

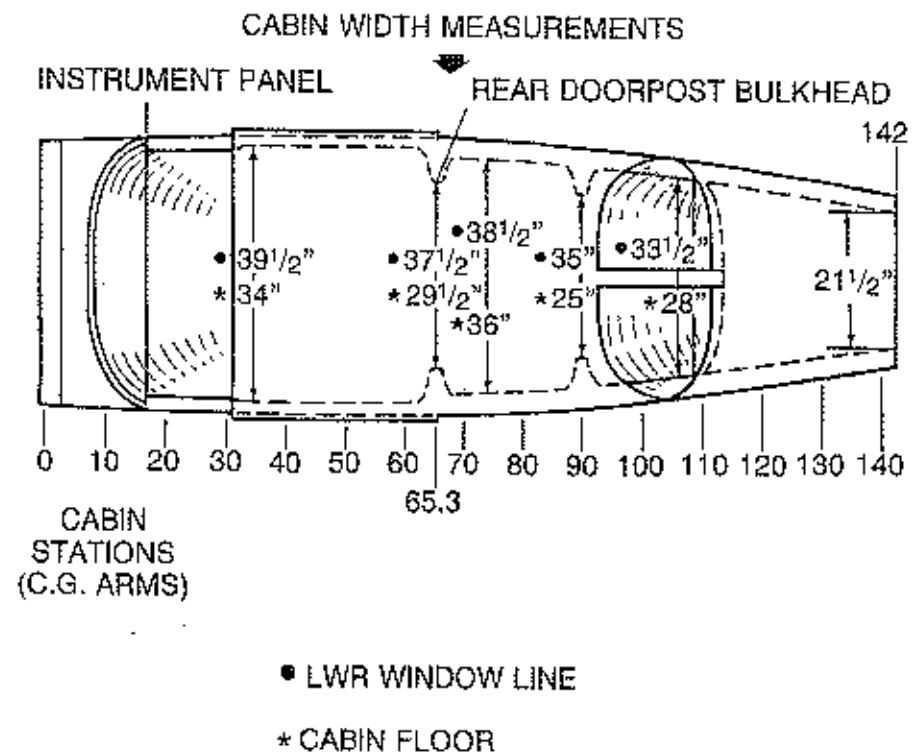

0585X1023

Figure 6-4. Internal Cabin Dimensions (Sheet 2 of 2)

| ITEM DESCRIPTION | WEIGHT AND MOMENT TABULATION | | | |
|---|------------------------------|------------------------|-----------------|------------------------|
| | SAMPLE AIRPLANE | | YOUR AIRPLANE | |
| | Weight (lbs.) | Moment (Lb-ins. /1000) | Weight (lbs.) | Moment (Lb-ins. /1000) |
| 1. Basic Empty Weight (Use the data pertaining to your airplane as it is presently equipped. Includes unusable fuel and full oil) | 1639 | 64.4 | <i>1645 lbs</i> | <i>65.12</i> |
| 2. Usable Fuel (At 6 Lbs./Gal.) | | | | |
| 53 Gallons Maximum | | | | |
| 35 Gallons (To reduced fuel indicator tab) | 210 | 10.1 | | |
| 3. Pilot and Front Passenger (Station 34 to 46) | 340 | 12.6 | | |
| 4. Rear Passengers | 220 | 16.0 | | |
| 5. *Baggage Area 1 (Station 82 to 108; 120 Lbs. Max.) | 48 | 3.4 | | |
| 6. *Baggage Area 2 (Station 108 to 142; 50 Lbs. Max.) | | | | |
| 7. RAMP WEIGHT AND MOMENT (add columns) | 2457 | 106.5 | | |
| 8. Fuel allowance for engine start, taxi and runup | -7.0 | -0.3 | | |
| 9. TAKEOFF WEIGHT AND MOMENT (Subtract Step 8 from Step 7) | 2450 | 106.2 | | |
| 10. Locate this point (2450 at 106.2) on the Center of Gravity Moment Envelope, and since this point falls within the envelope, the loading is acceptable. * The maximum allowable combined weight capacity for baggage areas 1 and 2 is 120 pounds. | | | | |

Figure 6-5. Sample Loading Problem (Sheet 1 of 2)

| YOUR AIRPLANE | | YOUR AIRPLANE | | YOUR AIRPLANE | |
|---------------|------------------------|---------------|------------------------|---------------|------------------------|
| Weight (lbs.) | Moment (Lb-ins. /1000) | Weight (lbs.) | Moment (Lb-ins. /1000) | Weight (lbs.) | Moment (Lb-ins. /1000) |
| 1100 | 100 | | | | |
| | | | | | |
| | | | | | |
| | | | | | |
| | | | | | |
| | | | | | |
| | | | | | |
| | | | | | |
| | | | | | |
| | | | | | |
| | | | | | |
| | | | | | |
| | | | | | |
| | | | | | |
| | | | | | |
| | | | | | |
| | | | | | |
| | | | | | |
| | | | | | |
| | | | | | |

NOTE

When several loading configurations are representative of your operations, it may be useful to fill out one or more of the above columns so specific loadings are available at a glance.

Figure 6-5. Sample Loading Problem (Sheet 2 of 2)

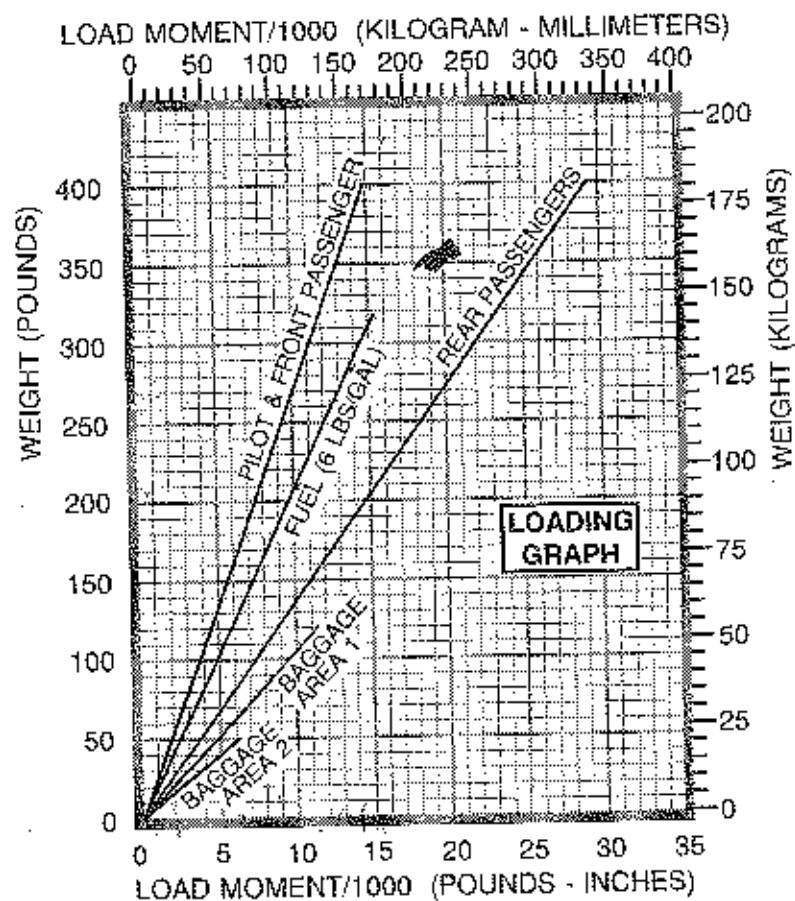

NOTE: LINE REPRESENTING ADJUSTABLE SEATS SHOWS THE PILOT OR PASSENGER CENTER OF GRAVITY ON ADJUSTABLE SEATS POSITIONED FOR AN AVERAGE OCCUPANT. REFER TO THE LOADING ARRANGEMENTS DIAGRAM FOR FORWARD AND AFT LIMITS OF OCCUPANT C.G. RANGE.

0586C1008

Figure 6-6. Loading Graph



LOADED AIRPLANE MOMENT/1000 (KILOGRAM-MILLIMETERS)

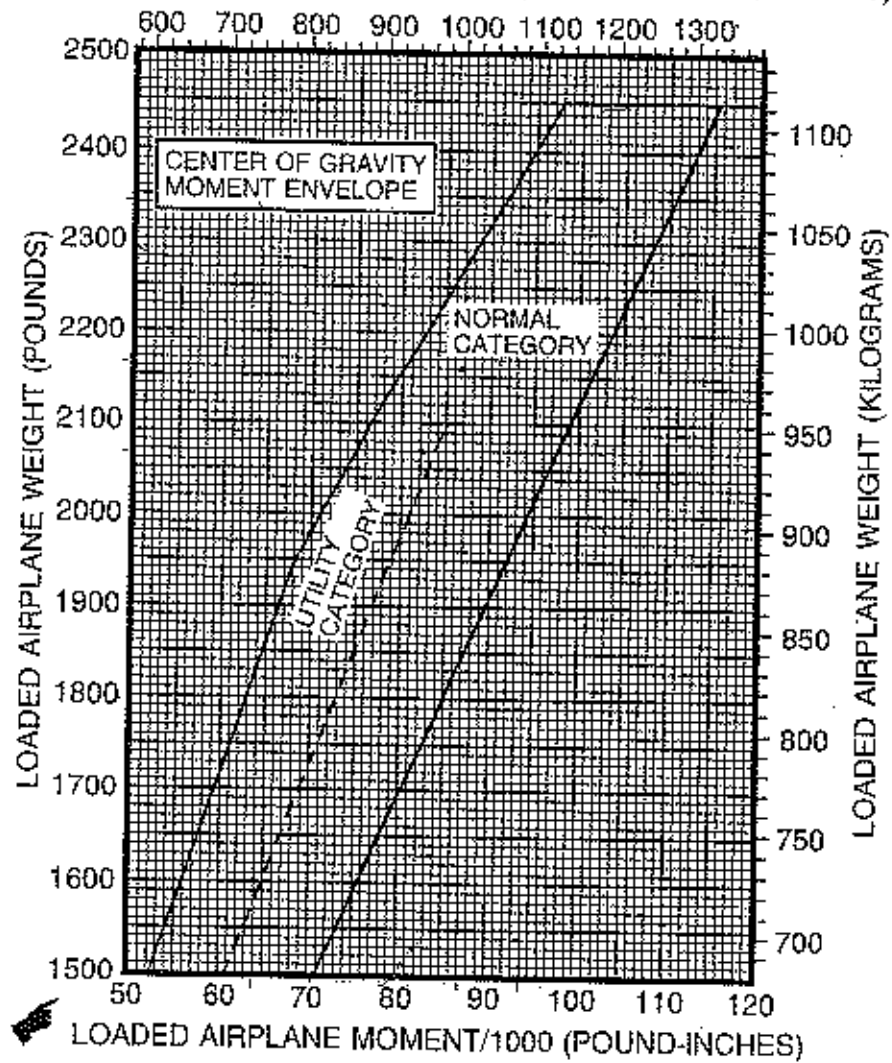

0585C1007

Figure 6-7. Center of Gravity Moment Envelope

SECTION 6
WEIGHT & BALANCE / EQUIPMENT LIST

CESSNA
MODEL 172R

AIRPLANE C.G. LOCATION - MILLIMETERS AFT OF DATUM
(STA. 0.0)

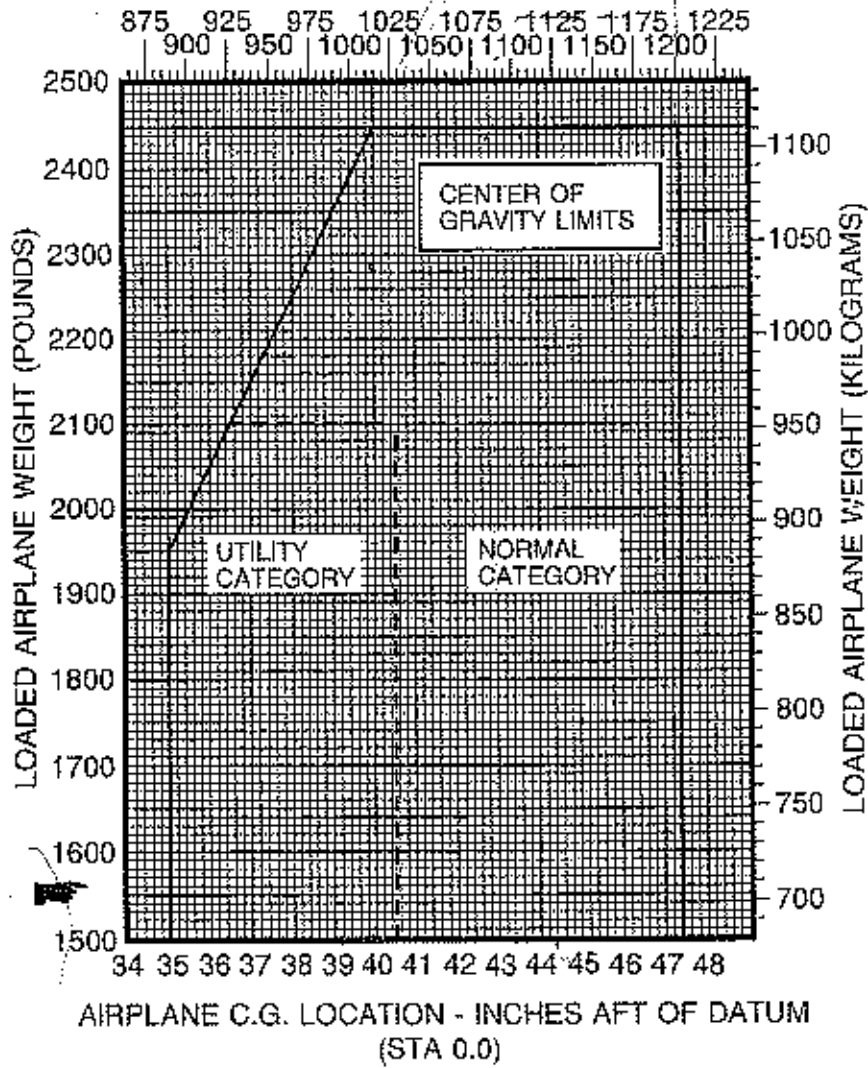

Figure 6-8. Center of Gravity Limits

0585C1008

7-1-00

Aircraft Weight and Balance Revision

| | | | | |
|---|-----------------------|--|--|------------------|
| Tail Number: N71755 | | Date: 02-01-2010 | | |
| Prepared by: | | Work Order No: | | |
| | | Type Certificate Data No: | | |
| Aircraft Make: Cessna | Model: 172R | Serial No: 17280800 | Time: | |
| Registered Owner: Jeff Kaminsky | | Address: 1225 Northfield DR NE Cedar Rapids IA 52402-7404 | | |
| Maximum Weight 2558 | | CG Range FWD 35/41 AFT 47.3 | | |
| As Received; Date of Previous Weight and Balance: N/A | Useful Load: 887.7 | EW: 1670.3 | EWCG: 39.115 | Moment: 65333 |
| Notes: The installation of STC SA10406SC increases the gross weight from 2450 to 2550 and ramp weight from 2457 to 2558. | | | | |
| | Weight | Arm | Moment | |
| Baggage net | -5 | 95.000 | -47.50 | |
| Tow Bar | -1.7 | 124.000 | -210.80 | |
| Lamar Startor | -11.2 | -23.0 | 257.60 | |
| Sky Tec starter FNE 149-NL/ec | 9.4 | -23.0 | -216.20 | |
| Nose Wheel Fairing | -3.5 | -3.5 | 12.25 | |
| Main Wheel Fairings (set of 2) | -10.1 | 61.1 | -617.11 | |
| Brake fairings (set of 2) | -1.1 | 55.6 | -61.16 | |
| | 0.00 | 0.00 | 0.00 | |
| | 0.00 | 0.00 | 0.00 | |
| | 0.00 | 0.00 | 0.00 | |
| <input checked="" type="checkbox"/> As Calculated | Moment | 64450.08 | New Empty Weight CG 39.02 | |
| <input type="checkbox"/> As Weighed | Weight | 1651.60 | | |
| Signature Brian K. Warkentin <i>Brian K. Warkentin</i> | | | Repair Agency A&P3430770 | |
| | | | or License No: | |

for use with wheel pants removed

COMPREHENSIVE EQUIPMENT LIST

The following figure (Figure 6-9) is a comprehensive list of all Cessna equipment which is available for the Model 172R airplane. This comprehensive equipment list provides the following information in column form:

In the **ITEM No.** column, each item is assigned a coded number. The first two digits of the code represent the assignment of the item within the Air Transport Association Specification 100 breakdown (11 for Paint and Placards; 24 for Electrical Power; 77 for Engine Indicating, etc...). These assignments also correspond to the Maintenance Manual chapter breakdown for the airplane. After the first two digits (and hyphen), items receive a unique sequence number (01, 02, 03, etc...). After the sequence number (and hyphen), a suffix letter is assigned to identify equipment as a required item, a standard item or an optional item. Suffix letters are as follows:

- R = required items or equipment for FAA certification
- S = standard equipment items
- O = optional equipment items replacing required or standard items
- A = optional equipment items which are in addition to required or standard items

In the **EQUIPMENT LIST DESCRIPTION** column, each item is assigned a descriptive name to help identify its function.

In the **REF DRAWING** column, a Cessna drawing number is provided which corresponds to the item.

NOTE

If additional equipment is to be installed, it must be done in accordance with the reference drawing, service bulletin or a separate FAA approval.

In the **WT LBS** and **ARM INS** columns, information is provided on the weight (in pounds) and arm (in inches) of the equipment item.

NOTES

Unless otherwise indicated, true values (not net change values) for the weight and arm are shown. Positive arms are distances aft of the airplane datum; negative arms are distances forward of the datum.

Asterisks (*) in the weight and arm column indicate complete assembly installations. Some major components of the assembly are listed on the lines immediately following. The sum of these major components does not necessarily equal the complete assembly installation.

SECTION 6
WEIGHT & BALANCE / EQUIPMENT LIST

CESSNA
MODEL 172R

| ITEM No. | EQUIPMENT LIST DESCRIPTION | REF DRAWING | WT LBS | ARM INS. |
|-----------------------------------|---------------------------------------|----------------|--------|----------|
| 11 - PLACARDS AND MARKINGS | | | | |
| 11-01-R | IFR DAY & NIGHT LIMITATIONS PLACARD | 0505087-3 | 0.0 | 43.0 |
| 11-02-S | PAINT, OVERALL EXTERIOR | 0504051 | 19.2* | 95.4' |
| | - OVERALL WHITE | | 18.4 | 93.6 |
| | - COLORED STRIP DECALS | | 0.8 | 135.9 |
| 21 - AIR CONDITIONING | | | | |
| 21-01-S | REAR SEAT AIR VENTS | 0513575-1 | 1.7 | 60.0 |
| 21-02-S | CABIN HEATER SYSTEM | 0554001-9 | 2.5 | -4.0 |
| 22 - AUTO FLIGHT | | | | |
| 22-02-A | SINGLE AXIS AUTO-PILOT (KAP 140) | 065-00176-2602 | 8.6* | 36.8* |
| | -AUTO-PILOT COMPUTER | 065-00179-0300 | 2.6 | 12.4 |
| | -ROLL ACTUATOR, WITH MOUNT | | 3.6 | 68.5 |
| | -DIRECTIONAL GYRO (EXCHANGE) | | 0.6 | 14.0 |
| | -CONFIGURATION MODULE | | 0.1 | 12.0 |
| | -CABLE ASSEMBLY | | 1.4 | 20.8 |
| 23 - COMMUNICATIONS | | | | |
| 23-01-S | STATIC DISCHARGE WICKS (SET OF 10) | 0501048-1 | 0.4 | 143.2 |
| 23-02-S | NAV/COM #1 INSTALLATION NO GS | 3930404-1 | 7.8* | 52.7* |
| | - KX 155A BENDIX/KING NAV/COM w/ GS | 066-01032-0201 | 3.5 | 12.5 |
| | - KI 208 NAV INDICATOR | 066-03056-0002 | 1.0 | 13.9 |
| | - VHF COM ANTENNA | 3960113-B | 0.6 | 61.2 |
| | - COM ANTENNA CABLE | 3921100-1 | 0.4 | 26.5 |
| | - OMNI NAV ANTENNA | | 0.6 | 253.4 |
| | - OMNI ANTENNA CO-AX CABLE | | 1.5 | 123.8 |
| | - HARDWARE AND CABLE ASSEMBLY | 3921100-1 | 0.5* | 53.2* |
| 23-03-A | NAV/COM INSTALLATION WITH GS | 3930404-1 | 6.5* | 17.1* |
| | - KX 155A BENDIX/KING NAV/COM w/GS | 066-01032-0201 | 4.0 | 12.5 |
| | - KI 209 NAV INDICATOR | 066-03056-0002 | 1.2 | 13.9 |
| | - VHF ANTENNA | 3960113-9 | 0.5 | 61.2 |
| | - ANTENNA COUPLER | 3930403-1 | 0.2 | 14.0 |
| | - HARDWARE AND CABLE ASSEMBLY | 3921101-1 | 0.2 | 3.6 |
| | - CO-AX, COM ANTENNA | | 0.4 | 26.5 |
| 23-04-S | AUDIO/INTERCOM/MARKER BEACON INSTL | 3900003-1 | 2.5* | 19.7* |
| | - KMA 26 AUDIO SWITCH PANEL | 066-01155-0101 | 1.7 | 14.8 |
| | - HARDWARE AND CABLE ASSEMBLY | 3900003-2 | 0.8 | 30.0 |
| 23-05-S | BASIC AVIONICS (USED WITH #1 NAV/COM) | 3900003-1 | 11.3* | 27.4* |
| | - MARKER BEACON ANTENNA | 3960108-1 | 0.6 | 130.7 |
| | - FUSELAGE AUDIO WIRING | | 7.9 | 26.5 |
| | - MICROPHONE - HANDHELD | | 0.2 | 16.0 |
| | - AVN COOLING FAN INSTL | | 1.2 | 6.5 |
| | - BASIC CIRCUIT BREAKER PANEL | 3930417 | 0.4 | 16.6 |

Figure 6-9. Equipment List Description (Sheet 1 of 7)

| ITEM No. | EQUIPMENT LIST DESCRIPTION | REF DRAWING | WT LBS | ARM INS. |
|----------|--|-----------------|--------|----------|
| | - AVN GROUND INSTL | 3830357 | 0.2 | 15.0 |
| | - MISC HARDWARE | | 0.9 | 16.0 |
| | 24 - ELECTRICAL POWER | | | |
| 24-01-R | ALTERNATOR, 28 VOLT 80 AMP | 9910591-5 | 10.0 | -29.0 |
| 24-02-R | BATTERY, 24 VOLT, 32.75 A.H. MANIFOLD TYPE | 0614002-01U3 | 23.2 | -5.0 |
| 24-03-R | POWER JUNCTION BOX (PRECISION AIRMOTIVE) | MC01-2A | 8.4* | 1.0* |
| | - ALTERNATOR CONTROL UNIT | AC2101 | 0.2 | 1.0 |
| | - MASTER CONTACTOR | X61-0007 | 0.7 | 1.0 |
| | - STARTER CONTACTOR | X61-0012 | 0.7 | 1.0 |
| | - AMMETER TRANSDUCER | CS 3100 | 0.1 | 1.0 |
| 24-04-S | BASIC AVIONICS KIT INSTALLATION | 3800002-1 | 3.6* | 13.1* |
| | - AVIONICS POWER AND BUS BAR | 0930299-1 | 0.3 | 17.0 |
| | 25 - EQUIPMENT/FURNISHINGS | | | |
| 25-01-R | SEAT, PILOT, VERTICAL ADJUST, CLOTH | 0514211-1 | 34.8 | 41.5 |
| 25-02-O | SEAT, PILOT, VERTICAL ADJUST, LEATHER | 0514211-5 | 35.0 | 41.5 |
| 25-03-O | SEAT, PILOT, VERTICAL ADJUST, LEATHER/VINYL | 0514211-9 | 34.8 | 41.5 |
| 25-04-S | SEAT, FRONT PASSENGER, VERTICAL ADJUST, CLOTH | 0514211-1 | 34.8 | 41.5 |
| 25-05-O | SEAT, FRONT PASSENGER, VERTICAL ADJUST, LEATHER | 0514211-5 | 35.0 | 41.5 |
| 25-06-O | SEAT, FRONT PASSENGER, VERTICAL ADJUST, LEATHER/VINYL | 0514211-8 | 34.8 | 41.5 |
| 25-07-S | SEAT, REAR, ONE PIECE BACK CUSHION, CLOTH | 0514219-1 | 43.3 | 79.5 |
| 25-08-O | SEAT, REAR, ONE PIECE BACK CUSHION, LEATHER | 0514219-2 | 44.7 | 79.5 |
| 25-09-O | SEAT, REAR, ONE PIECE BACK CUSHION, LEATHER/VINYL | 0514219-3 | 44.3 | 79.5 |
| 25-10-H | SEAT BELT AND SHOULDER HARNESS, INERTIA REEL, PILOT AND FRONT PASSENGER | 504516-401-8013 | 6.2 | 54.0 |
| 25-11-O | SEAT BELT AND SHOULDER HARNESS, MANUAL ADJUST, PILOT AND FRONT PASSENGER | 504851-401-8013 | 3.5 | 54.0 |
| 25-11-S | SEAT BELT AND SHOULDER HARNESS, INERTIA REEL, REAR SEAT (SET OF 2) | 504516-403-8013 | 6.2 | 80.0 |
| 25-12-O | SEAT BELT AND SHOULDER HARNESS, MANUAL ADJUST, REAR SEAT (SET OF 2) | 504851-403-8013 | 3.5 | 80.0 |
| 25-13-S | PADDED GLARESHIELD | 0514230-1 | 1.2 | 21.0 |
| 25-14-S | SUN VISORS | 0514306-2 | 1.1 | 32.8 |
| 25-15-S | BAGGAGE RETAINING NET | 2015009-7 | 0.6 | 95.0 |
| 25-16-S | CARGO TIE DOWN RINGS | 0515055-6 | 0.2 | 95.0 |
| 25-17-S | PILOT'S OPERATING CHECKLIST (STOWED IN INSTRUMENT PANEL MAP CASE) | 0500832-1 | 0.3 | 14.3 |

Figure 6-9. Equipment List Description (Sheet 2 of 7)

SECTION 6
WEIGHT & BALANCE / EQUIPMENT LIST

CESSNA
MODEL 172R

| ITEM No. | EQUIPMENT LIST DESCRIPTION | REF DRAWING | WT LBS | ARM INS. |
|----------|---|--------------|--------|----------|
| 25-18-R | PILOT'S OPERATING HANDBOOK AND FAA APPROVED AIRPLANE FLIGHT MANUAL (STOWED IN PILOT'S SEAT BACK CASE) | 0500832-1 | 1.2 | 50.0 |
| 25-19-S | FUEL SAMPLING CUP | 02107-1 | 0.1 | 14.3 |
| 25-20-S | TOW BAR, NOSE GEAR (STOWED) | 0501019-1 | 1.7 | 124.0 |
| 25-21-R | EMERGENCY LOCATOR TRANSMITTER INSTL. | 3940401-1 | 3.1* | 101.0* |
| | - ECT TRANSMITTER 3000-11 | 3940401-1 | 1.8 | 113.3 |
| | - ANTENNA AND CABLE ASSY, 3003-45 | 3940401-1 | 0.5 | 122.0 |
| | - HARDWARE | 3940401-1 | 0.1 | 118.3 |
| | 26 - FIRE PROTECTION | | | |
| 26-01-S | FIRE EXTINGUISHER INSTALLATION | 0501011-2 | 5.3* | 43.8* |
| | - FIRE EXTINGUISHER | C421001-0201 | 4.8 | 44.0 |
| | - MOUNTING CLAMP | C421001-0202 | 0.5 | 42.2 |
| | 27 - FLIGHT CONTROLS | | | |
| 27-01-S | DUAL CONTROLS INSTL, RIGHT SEAT | 0506008-1 | 5.5* | 12.4* |
| | - CONTROL WHEEL, RH | 0513576-2 | 2.0 | 26.0 |
| | - RUDDER & BRAKE PEDAL INSTL, RH | 0510402-16 | 1.1 | 6.8 |
| 27-02-S | CONTROL WHEEL, MAP LIGHT AND MIC. SWITCH INSTL (INCLUDES PANEL MOUNTED AUXILIARY MIC. JACK) | 0560059-1 | 0.2 | 22.0 |
| | 28 - FUEL | | | |
| 28-01-R | FUEL QUANTITY INDICATORS, LEFT & RIGHT | S3281-1 | 0.4 | 14.4 |
| 28-02-R | AUXILIARY FUEL PUMP | 6100-00-1 | 1.9 | 9.5 |
| | 31 - INDICATING/RECORDING SYSTEM | | | |
| 31-01-S | CLOCK/OAT INDICATOR, DIGITAL | M803B-2-0 | 0.7 | 18.5 |
| 31-02-S | HOUR RECORDED "HOBBS TIME" | C064503-0103 | 0.5* | 9.1* |
| 31-03-R | ANNUNCIATOR | 80-44001-1 | 0.5 | 18.0 |
| 31-04-R | STALL WARNING INDICATOR - PNEUMATIC | 0523112-2 | 0.4 | 28.5 |
| | 32 - LANDING GEAR | | | |
| 32-01-R | WHEEL BRAKE AND TIRE, 6.00 X 6 MAIN | 0541200-7,-8 | 34.4* | 57.9* |
| | - WHEEL ASSY, CLEVELAND (EACH) | C163001-0104 | 6.2 | 58.2 |
| | - BRAKE ASSY, CLEVELAND (EACH) | C163030-0111 | 1.8 | 54.5 |
| | - TIRE, 4-PLY BLACKWALL (EACH) | C262003-0101 | 7.9 | 58.2 |
| | - TUBE (EACH) | C262023-0102 | 1.3 | 58.2 |

Figure 6-9. Equipment List Description (Sheet 3 of 7)

| ITEM No. | EQUIPMENT LIST DESCRIPTION | REF DRAWING | WT LBS | ARM INS. |
|------------------------|---|----------------|--------|----------|
| 32-03-R | WHEEL AND TIRE, 6.00 X 6 NOSE | 0543062-17 | 9.5* | -6.6* |
| | - WHEEL ASSY, CLEVELAND | 1241156-12 | 3.5 | -6.6 |
| | - TIRE, 6-PLY BLACKWALL | 0262003-0202 | 4.6 | -6.8 |
| | - TUBE | 0262023-0101 | 1.4 | -6.8 |
| 32-03-A | WHEEL FAIRINGS AND INSTALLATION | 0541225-1 | 16.5* | 46.1* |
| | - NOSE WHEEL FAIRING | 0543079-3 | 3.5 | -3.5 |
| | - MAIN WHEEL FAIRINGS (SET OF 2) | 0541223-1, -2 | 10.1 | 61.1 |
| | - BRAKE FAIRINGS (SET OF 2) | 0541224-1, -2 | 1.1 | 55.6 |
| | - MOUNTING PLATE (SET OF 2) | 0541220-1, -2 | 0.8 | 59.5 |
| 33 - LIGHTS | | | | |
| 33-01-S | COURTESY LIGHTS UNDER WING (SET OF 2) | 0521101-8 | 0.5 | 61.0 |
| 33-02-S | NAVIGATION LIGHT DETECTORS (SET OF 2) | 0701013-1, -2 | 0.0 | 40.8 |
| 33-03-S | FLASHING BEACON LIGHT ON VERTICAL FIN TIP | 0506002-6 | 1.4 | 204.7 |
| 33-04-S | STROBE LIGHT INSTALLATION ON WING TIPS | 0501027-6 | 3.4 | 43.3 |
| 33-05-S | LANDING AND TAXI LIGHT INSTL IN WINGS | 0523028-2, -7 | 2.2 | 25.3 |
| 34 - NAVIGATION | | | | |
| 34-01-R | INDICATOR, AIRSPEED | S3325-1 | 0.6 | 16.2 |
| 34-02-S | ALTERNATE STATIC AIR SOURCE | 0501017-1 | 0.2 | 15.5 |
| 34-03-R | ALTIMETER WITH 20 FT. MARKINGS, INCHES OF MERCURY | S3323-1 | 0.9 | 14.0 |
| 34-04-O | ALTIMETER WITH 20 FT. MARKINGS, FEET & MILLIBAR | S3371-1 | 0.9 | 14.0 |
| 34-05-S | BLIND ALTITUDE ENCODER INSTL | 3930402-1 | 0.9 | 11.0 |
| 34-06-R | COMPASS INSTL, MAGNETIC | 0513262-2 | 0.5 | 14.0 |
| 34-07-S | GYRO, INSTALLATION (REQUIRES 37-01-B) | 0501135-1 | 8.0* | 13.0* |
| | - DIRECTIONAL GYRO | S3330-1 | 2.3 | 14.0 |
| | - ATTITUDE GYRO | S3226-1 | 2.1 | 14.0 |
| | - HOSE AND MISC HARDWARE | 0501135-1 | 1.5 | 10.0 |
| 34-08-S | TURN COORDINATOR INDICATOR FOR AUTO PILOT | S3291-1 | 1.2 | 14.7 |
| 34-09-S | VERTICAL SPEED INDICATOR | S3327-1 | 0.8 | 15.7 |
| 34-10-A | ADF INSTALLATION | 3930404-1 | 10.4* | 25.9* |
| | - KR 87 ADF RECEIVER | 086-01072-0014 | 3.2 | 12.1 |
| | - KI 227 ADF INDICATOR | 066-03063-0000 | 0.7 | 15.9 |
| | - ADF ANTENNA | 3960187-1 | 4.2 | 39.3 |
| | - ADF CABLE ASSEMBLY | 3922102-1 | 2.3 | 29.0 |
| 34-11-A | GPS INSTALLATION | 3930404-1 | 4.4* | 16.3* |
| | - KING GPS-VFR, KLN-89 | 066-01148-1111 | 3.3 | 12.4 |
| | - GPS ANTENNA | 3960190-1 | 0.3 | 43.5 |
| | - GPS CABLE ASSEMBLY | 3928101-1 | 0.8 | 14.1 |

Figure 6-9. Equipment List Description (Sheet 4 of 7)

SECTION 6
WEIGHT & BALANCE / EQUIPMENT LIST

CESSNA
MODEL 172R

| ITEM No. | EQUIPMENT LIST DESCRIPTION | REF DRAWING | WT LBS | ARM INS. |
|----------|---|--------------------|--------|----------|
| 34-12-S | MODE C TRANSPONDER INSTL | 3930404-1 | 4.1* | 18.7* |
| | - KT 76C TRANSPONDER | 066-01186-0101 | 2.4 | 13.5 |
| | - TRANS CAL BLIND ENCODER | 3930402-1 | 0.8 | 10.9 |
| | - TRANSPONDER ANTENNA | 3960191-1 | 0.2 | 85.3 |
| | - HARDWARE AND CABLE ASSEMBLY | 3923102-1 | 0.6 | 28.9 |
| 34-13-O | HORIZONTAL SITUATION INDICATOR INSTL (NET WT INCREASE) (REQUIRED 37-01-S) | 3900016-1 | 15.3* | 84.1* |
| | - HSI INDICATOR | 066-03046-0007 | 3.4 | 13.4 |
| | - GYRO SLAVING ACCESSORY | 071-01242-0006 | 0.3 | 15.8 |
| | - FLUX DETECTOR INSTL IN LH WING | 3940364-1 | 0.7 | 52.6 |
| | - REMOTE DIRECTION GYRO - SLAVED | 3940365-1 | 5.1 | 112.5 |
| | - NAV CONVERTER INSTL | 3940366-1 | 1.6 | 117.0 |
| | - WIRING | 3900016 | 8.0 | 80.7 |
| | - STD GYRO INSTL (REMOVED) | 0501135 | -13.6 | 3.6 |
| | - GYRO INSTL FOR HSI INSTALLED | 0501171-1 | 11.0 | 1.6 |
| | - REMOVE #1 NAV INDICATOR | | -1.2 | 13.9 |
| | | 37 - VACUUM | | |
| 37-01-S | VACUUM SYSTEM, ENGINE DRIVEN, DUAL | | 6.4* | -1.8* |
| | - VACUUM PUMP, AIRBORNE 211CC | E211CC | 1.9 | -8.5 |
| | - VACUUM PUMP, AIRBORNE 212CW | E212CW | 1.9 | -3.9 |
| | - COOLING SHROUD, AIRBORNE 2CDH | 2CDH | 0.1 | -6.5 |
| | - COOLING SHROUD, AIRBORNE 2CDH | 2CDH | 0.1 | -3.9 |
| | - FILTER INSTALLATION | 1201075-2 | 0.3 | 5.3 |
| | - VACUUM GAGE/AMMETER | S3280-1 | 0.3 | 14.3 |
| | - VACUUM RELIEF VALVE | 2H3-48 | 0.3 | 4.8 |
| | - MANIFOLD | 1H5-25 | 0.6 | -0.2 |
| 37-02-R | VACUUM GAGE/AMMETER | S3280-1 | 0.3 | 14.3 |
| 37-03-S | LOW VACUUM WARNING LIGHT, VACUUM PUMP | 0506008-1 | 0.0 | 16.0 |
| | 53 - FUSELAGE | | | |
| 63-01-S | REFUELING STEPS AND HANDLE INSTL | 0513415-2 | 1.7 | 16.3 |
| | 56 - WINDOWS | | | |
| 56-01-S | WINDOW, HINGED RIGHT DOOR, OPENABLE | 0517001-40 | 5.8* | 48.5* |
| 56-02-R | WINDOW, HINGED LEFT DOOR, OPENABLE | 0517001-39 | 5.8* | 48.6* |
| | 57 - WINGS | | | |
| 57-01-O | HEAVY DUTY FLAPS, (WT SHOWN, NET CHNG) | | | |
| | - TWO (2) FLAPS (EXCHANGED) | 0523902 | 2.2 | 83.2 |
| | - ONE (1) FLAP (EXCHANGED) | 0523902 | 1.1 | 83.2 |

Figure 6-9. Equipment List Description (Sheet 5 of 7)

| ITEM No. | EQUIPMENT LIST DESCRIPTION | REF DRAWING | WT LBS | ARM INS. |
|---------------------------------------|---|---------------|--------|----------|
| 61 - PROPELLER | | | | |
| 61-01-R | PROPELLER ASSY, FIXED PITCH | 0550320-14 | 38.8* | -38.2* |
| | - PROPELLER, 76 INCH MCCAULEY | 1C235/LFA7570 | 35.0 | -38.4 |
| | - PROP SPACER ADAPTER, 3.5 INCH MCCAULEY | | 3.8 | -36.0 |
| 61-02-R | SPINNER INSTALLATION, PROPELLER | 0550320-14 | 1.8* | -41.0* |
| | - SPINNER DOME ASSEMBLY | 0550367-1 | 1.0 | -42.6 |
| | - FWD SPINNER BULKHEAD | 0552231-2 | 0.3 | -40.8 |
| | - AFT SPINNER BULKHEAD | 0550321-10 | 0.4 | -37.3 |
| 71 - POWERPLANT | | | | |
| 71-01-R | FILTER, AIR INTAKE, DONALDSON | P198281 | 0.3 | -27.5 |
| 71-02-S | WINTERIZATION KIT INSTL (INSTALLED ARM SHOWN) | 0601128-3 | 0.8* | -20.3* |
| | - BREATHER TUBE INSTALLATION | 0652011 | 0.4 | -13.8 |
| | - COWL INLET COVERS (INSTALLED) | 0662229-3,-4 | 0.3 | -32.0 |
| | - COWL INLET COVERS (STOWED) | 0652229-3,-4 | 0.3 | 95.0 |
| 71-03-R | ENGINE, LYCOMING IO-360-E2A | 0550359-2 | 297.8* | -18.8* |
| | - FUEL INJECTOR, PAC RSA-5AD1 | | 7.6 | -13.9 |
| | - MAGNETOS & HARNESS, SLICK 4371 (SET OF 2) | | 9.0 | -5.0 |
| | - OIL FILTER AND ADAPTER | | 2.5 | -18.5 |
| | - SPARK PLUGS | | 1.9 | -13.9 |
| | - STARTER, LAMAR 31820307 | | 14.2 | -23.0 |
| | <i>31820307 FIVE 149-06</i> | | 9.4 | |
| 73 - ENGINE FUEL & CONTROL | | | | |
| 73-01-S | EGT/FUEL FLOW INDICATOR | S3277-4 | 0.6 | 7.8 |
| 77 - ENGINE INDICATING | | | | |
| 77-01-R | TACHOMETER, RECORDING | S3329-1 | 1.0 | 12.1 |
| 78 - EXHAUST | | | | |
| 78-01-R | EXHAUST SYSTEM INSTALLATION | 0554012-1 | 16.3* | -20.0* |
| | - MUFFLER & TAILPIPE WELD ASSY | 0554011-2 | 4.6 | -22.7 |
| | - SHROUD ASSY, MUFFLER HEATER | 0554001-9 | 0.8 | -22.7 |
| 79 - OIL | | | | |
| 79-01-R | OIL COOLER INSTALLATION | 0550359-2 | 3.3* | -11.0* |
| | - OIL COOLER, STEWART WARNER | 8406-R | 2.3 | -11.0 |
| 79-02-R | OIL PRESSURE & TEMPERATURE INDICATORS | S3279-1 | 0.4 | 18.6 |
| 98 - AVIONICS PACKAGE OPTIONS | | | | |
| 98-01-S | STANDARD AVIONICS PACKAGE | 3900003-1 | 28.0* | 92.2* |
| | - 23-06-S BASIC AVN KIT INSTL | 3900002-1 | 11.3 | 27.4 |
| | - 23-04-S AUDIO/INTERCOM/MARKER BEACON INSTL | 3930404-1 | 2.5 | 19.7 |

Figure 6-9. Equipment List Description (Sheet 6 of 7)

SECTION 6
WEIGHT & BALANCE / EQUIPMENT LIST

CESSNA
MODEL 172R

| ITEM No. | EQUIPMENT LIST DESCRIPTION | REF DRAWING | WT LBS | ARM INS. |
|----------|---|-------------|--------|----------|
| | - 23-02-S NAV/COM INSTL | 3830404-1 | 7.9 | 62.7 |
| | - MODE C TRANSPONDER INSTL (34-11-S) | 3830404-1 | 4.5 | 15.2 |
| 98-02-A | TRAINER AVIONICS PACKAGE (NET CHG OVER STD AVN PKG) | 3900004-1 | 21.3* | 21.5* |
| | - 23-03-A NAV/COM WITH GLIDESLOPE | 3830404-1 | 6.6 | 17.1 |
| | - 34-09-A ADF INSTALLATION | 3830404-1 | 10.4 | 28.9 |
| | - 34-10-A GLOBAL POSITIONING SYSTEM (GPS) | | 4.4 | 15.3 |
| 98-03-A | NAV II PACKAGE (NET CHG OVER STD AVN PKG) | 3900005-1 | 29.9* | 25.9* |
| | - 98-02-A TRAINER AVN PKG | | 21.3 | 21.5 |
| | - 22-02-A SINGLE AXIS AUTOPILOT | | 8.6 | 36.8 |
| | - GPS INSTALLATION | 3830404-1 | 4.4 | 17.6 |
| 98-04-A | NAV II PACKAGE WITH HSI (NET CHG OVER STD AVN PKG) | 3900018-1 | 45.2* | 45.8* |
| | - 98-03-A NAV II PACKAGE | | 29.9 | 25.9 |
| | - 34-12-D HORIZONTAL SITUATION INDICATOR (HSI) GYRO INSTL | | 15.3 | 84.1 |

Figure 6-9. Equipment List Description (Sheet 7 of 7)

Handwritten text, likely bleed-through from the reverse side of the page. The text is extremely faint and illegible due to the quality of the scan and the density of the characters.

SECTION 7 AIRPLANE & SYSTEMS DESCRIPTION

TABLE OF CONTENTS

| | Page |
|---|------|
| Introduction | 7-5 |
| Airframe | 7-5 |
| Flight Controls | 7-6 |
| Trim System | 7-9 |
| Instrument Panel | 7-9 |
| Pilot Side Panel Layout | 7-9 |
| Center Panel Layout | 7-9 |
| Copilot Side Panel Layout | 7-12 |
| Center Pedestal Layout | 7-12 |
| Ground Control | 7-12 |
| Wing Flap System | 7-13 |
| Landing Gear System | 7-14 |
| Baggage Compartment | 7-14 |
| Seats | 7-14 |
| Integrated Seat Belt/Shoulder Harness | 7-15 |
| Entrance Doors And Cabin Windows | 7-17 |
| Control Locks | 7-18 |

TABLE OF CONTENTS (Continued)

| | Page |
|---|------|
| Engine | 7-19 |
| Engine Controls | 7-19 |
| * Engine Instruments | 7-19 |
| New Engine Break In And Operation | 7-21 |
| Engine Lubrication System | 7-21 |
| Ignition And Starter System | 7-22 |
| Air Induction System | 7-22 |
| Exhaust System | 7-23 |
| Cooling System | 7-23 |
| * Propeller | 7-23 |
| Fuel System | 7-23 |
| Fuel Distribution | 7-24 |
| Fuel Indicating | 7-25 |
| Fuel Venting | 7-26 |
| Reduced Tank Capacity | 7-26 |
| Fuel Selector Valve | 7-26 |
| Fuel Drain Valves | 7-28 |
| Brake System | 7-29 |
| Electrical System | 7-29 |
| Annunciator Panel | 7-32 |
| Master Switch | 7-33 |
| I Avionics Master Switch | 7-34 |
| Ammeter | 7-34 |
| Low Voltage Annunciation | 7-34 |
| Circuit Breakers And Fuses | 7-35 |
| Ground Service Plug Receptacle | 7-35 |

500
310

TABLE OF CONTENTS (Continued)

| | Page |
|--|------|
| Lighting Systems | 7-37 |
| Exterior Lighting | 7-37 |
| Interior Lighting | 7-37 |
| Cabin Heating, Ventilating And Defrosting System | 7-39 |
| Pitot-Static System And Instruments | 7-41 |
| Airspeed Indicator | 7-42 |
| Vertical Speed Indicator | 7-42 |
| Altimeter | 7-43 |
| Vacuum System And Instruments | 7-43 |
| Attitude Indicator | 7-43 |
| Directional Indicator | 7-43 |
| Suction Gauge | 7-45 |
| Low Vacuum Annunciation | 7-45 |
| Clock / OAT Gauge | 7-46 |
| Stall Warning System | 7-46 |
| Standard Avionics | 7-46 |
| Avionics Support Equipment | 7-47 |
| Avionics Cooling Fan | 7-47 |
| Microphone And Headset Installations | 7-47 |
| Static Dischargers | 7-48 |
| Cabin Features | 7-49 |
| Emergency Locator Transmitter (ELT) | 7-49 |
| Cabin Fire Extinguisher | 7-49 |

INTRODUCTION

This section provides description and operation of the airplane and its systems. Some equipment described herein is optional and may not be installed in the airplane. Refer to the Supplements, Section 9 for details of other optional systems and equipment.

AIRFRAME

The airplane is an all metal, four-place, high wing, single engine airplane equipped with tricycle landing gear and is designed for general utility and training purposes.

The construction of the fuselage is a conventional formed sheet metal bulkhead, stringer, and skin design referred to as semimonocoque. Major items of structure are the front and rear carry through spars to which the wings are attached, a bulkhead and forgings for main landing gear attachment at the base of the rear door posts, and a bulkhead with attach fittings at the base of the forward door posts for the lower attachment of the wing struts. Four engine mount stringers are also attached to the forward door posts and extend forward to the firewall.

The externally braced wings, containing integral fuel tanks, are constructed of a front and rear spar with formed sheet metal ribs, doublers, and stringers. The entire structure is covered with aluminum skin. The front spars are equipped with wing-to-fuselage and wing-to-strut attach fittings. The aft spars are equipped with wing-to-fuselage attach fittings, and are partial span spars. Conventional hinged ailerons and single slot type flaps are attached to the trailing edge of the wings. The ailerons are constructed of a forward spar containing balance weights, formed sheet metal ribs and "V" type corrugated aluminum skin joined together at the trailing edge. The flaps are constructed basically the same as the ailerons, with the exception of the balance weights and the addition of a formed sheet metal leading edge section.

The empennage (tail assembly) consists of a conventional vertical stabilizer, rudder, horizontal stabilizer, and elevator. The vertical stabilizer consists of a spar, formed sheet metal ribs and reinforcements, a wraparound skin panel, formed leading edge skin and a dorsal. The rudder is constructed of a formed leading edge skin and spar with attached hinge brackets and ribs, a center spar, a wrap around skin, and a ground adjustable trim tab at the base of the trailing edge. The top of the rudder incorporates a leading edge extension which contains a balance weight.

The horizontal stabilizer is constructed of a forward and aft spar, ribs and stiffeners, center, left, and right wrap around skin panels, and formed leading edge skins. The horizontal stabilizer also contains the elevator trim tab actuator.

Construction of the elevator consists of formed leading edge skins, a forward spar, aft channel, ribs, torque tube and bellcrank, left upper and lower "V" type corrugated skins, and right upper and lower "V" type corrugated skins incorporating a trailing edge cutout for the trim tab. The elevator tip leading edge extensions incorporate balance weights. The elevator trim tab consists of a spar, rib, and upper and lower "V" type corrugated skins.

FLIGHT CONTROLS

The airplane's flight control system (Refer to Figure 7-1) consists of conventional aileron, rudder, and elevator control surfaces. The control surfaces are manually operated through cables and mechanical linkage using a control wheel for the ailerons and elevator, and rudder/brake pedals for the rudder.

TRIM SYSTEM

A manually operated elevator trim system is provided (Refer to Figure 7-1). Elevator trimming is accomplished through the elevator trim tab by utilizing the vertically mounted trim control wheel in the cockpit. Forward rotation of the trim wheel will trim nose down; conversely, aft rotation will trim nose up.

AILERON CONTROL SYSTEM

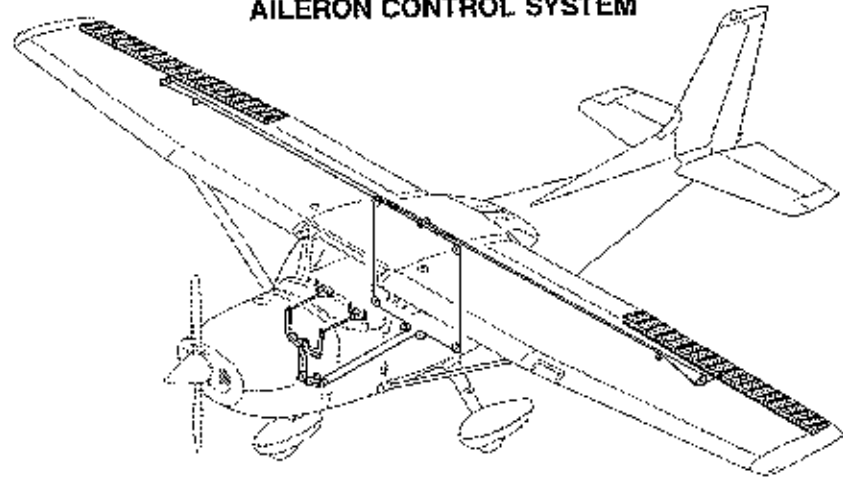

RUDDER CONTROL SYSTEM

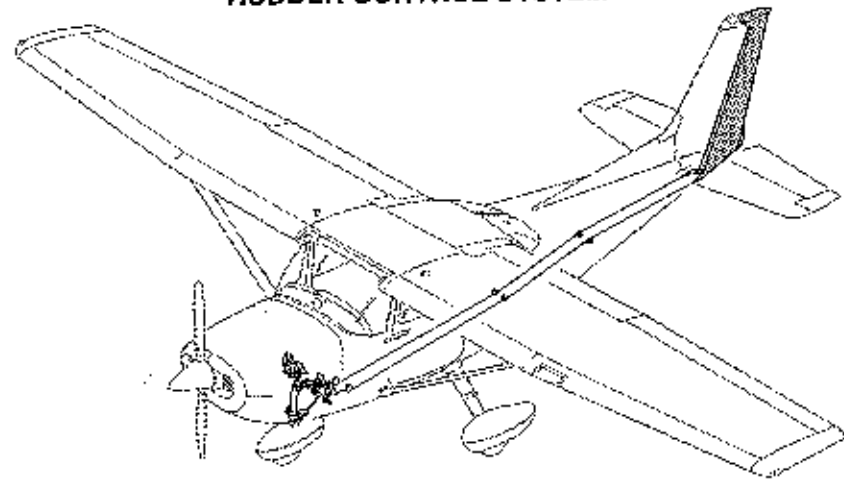

0585X1017

Figure 7-1. Flight Control and Trim Systems (Sheet 1 of 2)

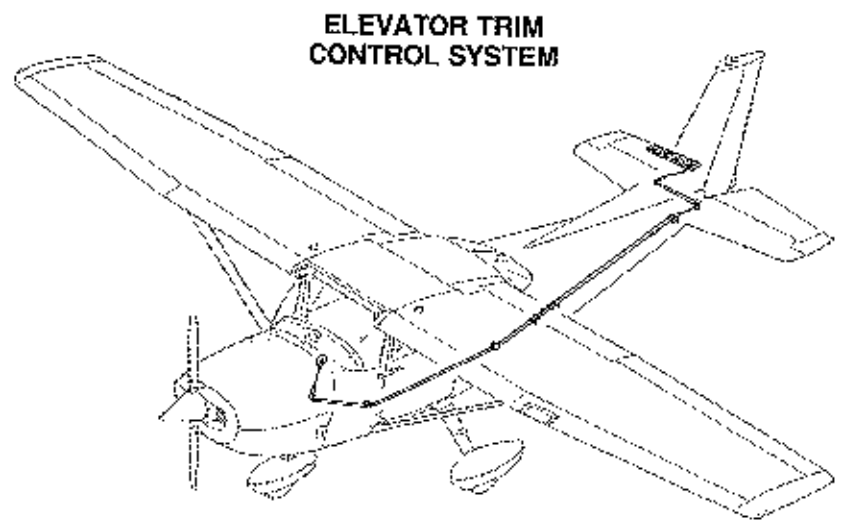
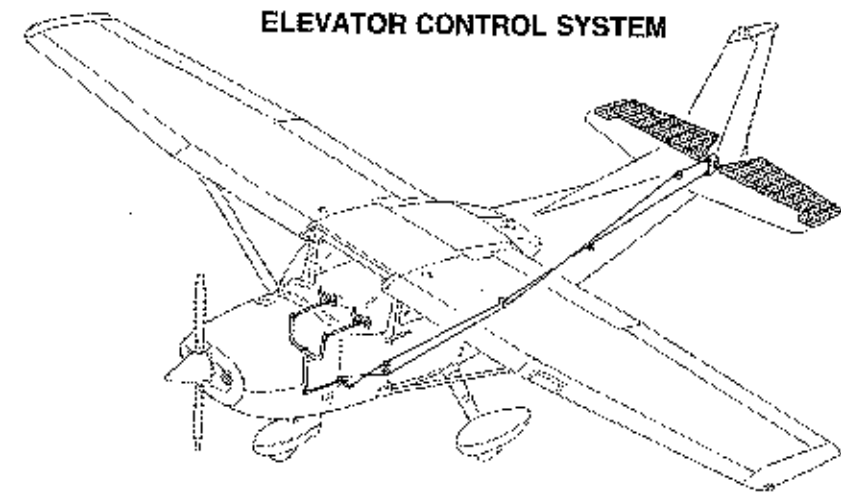

0585X101B

Figure 7-1. Flight Control and Trim Systems (Sheet 2 of 2)

INSTRUMENT PANEL

The instrument panel (Refer to Figure 7-2) is of all-metal construction, and is designed in segments to allow related groups of instruments, switches and controls to be removed without removing the entire panel. For specific details concerning the instruments, switches, circuit breakers, and controls on the instrument panel, refer to related topics in this section.

PILOT PANEL LAYOUT

Flight instruments are contained in a single panel located in front of the pilot. These instruments are designed around the basic "T" configuration. The gyros are located immediately in front of the pilot, and arranged vertically over the control column. The airspeed indicator and altimeter are located to the left and right of the gyros, respectively. The remainder of the flight instruments are clustered around the basic "T". An annunciator panel is located above the altimeter and provides caution and warning messages for fuel quantity, oil pressure, low vacuum and low voltage situations.

To the right of the flight instruments is a sub panel which contains engine tachometer and various navigational heading instruments. To the left of the flight instruments is a sub panel which contains a left/right fuel quantity indicator, an oil temperature/oil pressure indicator, a vacuum gage/ammeter, an EGT/fuel flow indicator, a digital clock/OAT indicator and the avionics circuit breaker panel.

Below the engine and flight instruments are circuit breakers and switches for the airplane systems and equipment. Master, Avionics Master and Ignition Switches are also located in this area of the panel. The parking brake control is positioned below the switch and circuit breaker panel.

CENTER PANEL LAYOUT

The center panel contains various avionics equipment arranged in a vertical rack. This arrangement allows each component to be removed without having to access the backside of the panel. Below the panel are the throttle, mixture, alternate static air and lighting controls.

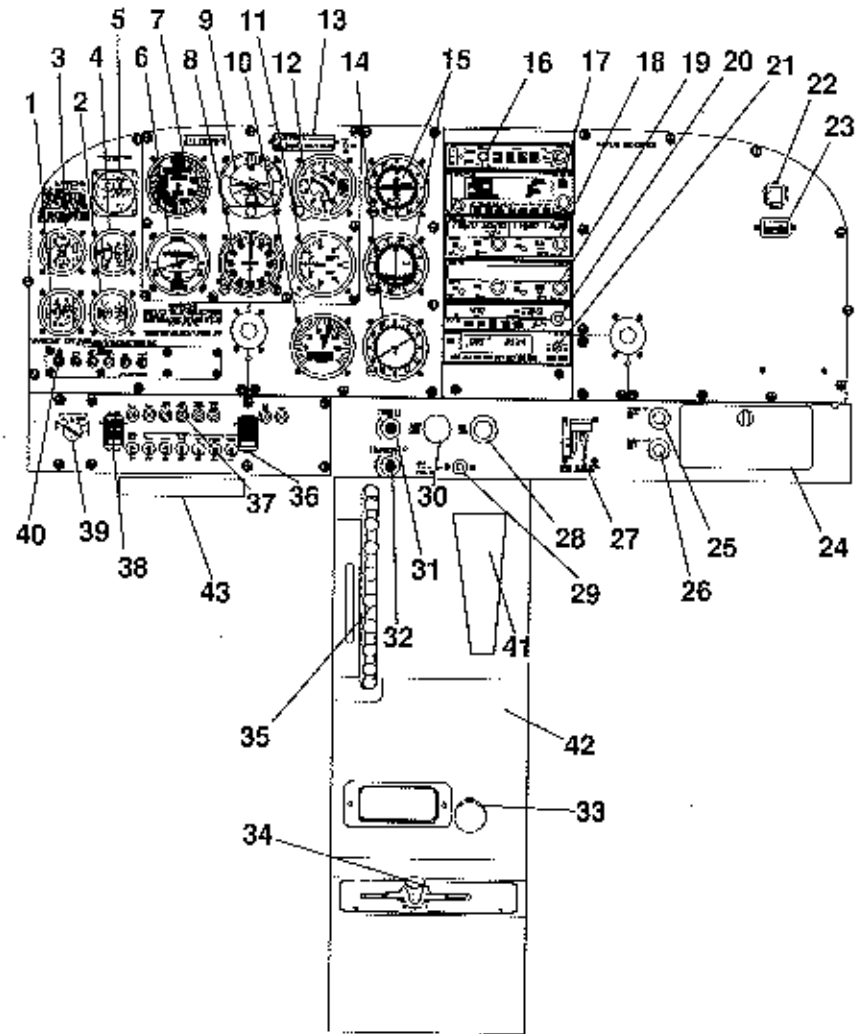

0585C-1040

Figure 7-2. Instrument Panel (Sheet 1 of 2)

- | | |
|---|--|
| 1. Oil Temperature and Oil Pressure Indicator | 23. Hour Meter |
| 2. Vacuum Gage and Ammeter | 24. Glove Box |
| 3. Fuel Quantity Indicator | 25. Cabin Heat Control |
| 4. EGT/Fuel Flow Indicator | 26. Cabin Air Control |
| 5. Digital Clock / O.A.T. Indicator | 27. Flap Switch and Position Indicator |
| 6. Turn Coordinator | 28. Mixture Control |
| 7. Airspeed Indicator | 29. Alternate Static Air Control |
| 8. Directional Gyro | 30. Throttle Control |
| 9. Attitude Indicator | 31. Radio and Panel Dimming Control |
| 10. Tachometer | 32. Glareshield and Pedestal Dimming Control |
| 11. Vertical Speed Indicator | 33. Fuel Shutoff Valve Control |
| 12. Altimeter | 34. Fuel Selector |
| 13. Annunciator Panel | 35. Elevator Trim Control and Position Indicator |
| 14. ADF Bearing Indicator | 36. Avionics Master Switch |
| 15. Course Deviation and Glide Slope Indicators | 37. Circuit Breakers and Switch/Breakers |
| 16. Audio Control Panel | 38. Master Switch |
| 17. GPS Receiver | 39. Ignition Switch |
| 18. Nav/Com Radio #1 | 40. Avionics Circuit Breaker Panel |
| 19. Nav/Com Radio #2 | 41. Hand Held Microphone |
| 20. ADF Receiver | 42. 12 VDC Power Port (Location may vary) |
| 21. Transponder | 43. Parking Brake |
| 22. ELT Remote Test Button | |

Figure 7-2. Instrument Panel (Sheet 2)

RH PANEL LAYOUT

The RH panel contains the hour meter, ELT switch, and room for expansion of indicators and other avionics equipment. Below this sub panel are the glove box, cabin heat and cabin air controls, and wing flap switch.

CENTER PEDESTAL LAYOUT

The center pedestal, located below the center panel, contains the elevator trim control wheel, position indicator, handheld microphone bracket and fuel shutoff valve control. The fuel selector valve handle is located at the base of the pedestal.

GROUND CONTROL

Effective ground control while taxiing is accomplished through nose wheel steering by using the rudder pedals; left rudder pedal to steer left and right rudder pedal to steer right. When a rudder pedal is depressed, a spring loaded steering bungee (which is connected to the nose gear and to the rudder bars) will turn the nose wheel through an arc of approximately 10° each side of center. By applying either left or right brake, the degree of turn may be increased up to 30° each side of center.

Moving the airplane by hand is most easily accomplished by attaching a tow bar to the nose gear strut. If a tow bar is not available, or pushing is required, use the wing struts as push points. Do not use the vertical or horizontal surfaces to move the airplane. If the airplane is to be towed by vehicle, never turn the nose wheel more than 30° either side of center or structural damage to the nose gear could result.

The minimum turning radius of the airplane, using differential braking and nose wheel steering during taxi, is approximately 27 feet. To obtain a minimum radius turn during ground handling, the airplane may be rotated around either main landing gear by pressing down on a tailcone bulkhead just forward of the horizontal stabilizer to raise the nose wheel off the ground. Care should be exercised to ensure that pressure is exerted only on the bulkhead area and not on skin between the bulkheads. Pressing down on the horizontal stabilizer is not recommended.

WING FLAP SYSTEM

The single-slot type wing flaps (Refer to Figure 7-3), are extended or retracted by positioning the wing flap switch lever on the instrument panel to the desired flap deflection position. The switch lever is moved up or down in a slotted panel that provides mechanical stops at the 10°, 20° and 30° positions. To change flap setting, the flap lever is moved to the right to clear mechanical stops at the 10° and 20° positions. A scale and pointer to the left of the flap switch indicates flap travel in degrees. The wing flap system circuit is protected by a 10-ampere circuit breaker, labeled FLAP, on the left side of the control panel.

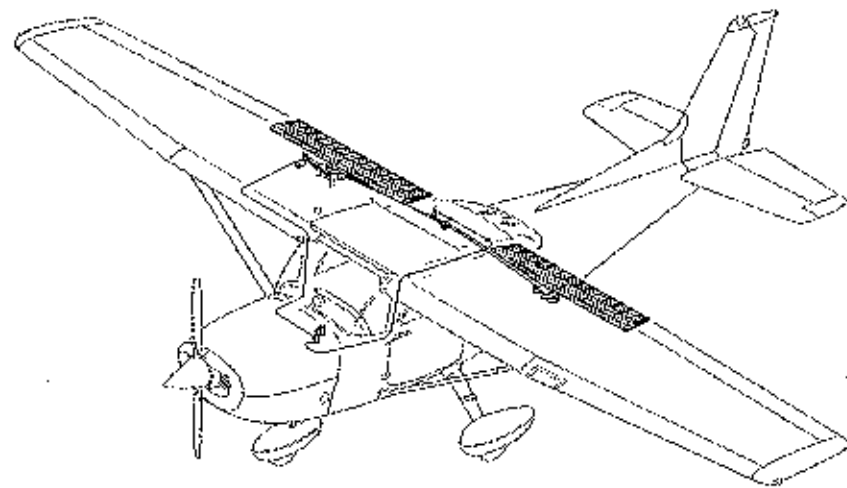

0585X1024

Figure 7-3. Wing Flap System

LANDING GEAR SYSTEM

The landing gear is of the tricycle type, with a steerable nose wheel and two main wheels. Wheel fairings are optional equipment for both the main and nose wheels. Shock absorption is provided by the tubular spring steel main landing gear struts and the air/oil nose gear shock strut. Each main gear wheel is equipped with a hydraulically actuated disc type brake on the inboard side of each wheel.

BAGGAGE COMPARTMENT

The baggage compartment consists of two areas, one extending from behind the rear passenger seat to the aft cabin bulkhead, and an additional area aft of the bulkhead. Access to both baggage areas is gained through a lockable baggage door on the left side of the airplane, or from within the airplane cabin. A baggage net with tiedown straps is provided for securing baggage and is attached by tying the straps to tiedown rings provided in the airplane. For baggage area and door dimensions, refer to Section 6.

SEATS

The seating arrangement consists of two vertically adjusting crew seats for the pilot and front seat passenger, and a single bench seat with adjustable back for rear seat passengers.

Seats used for the pilot and front seat passenger are adjustable fore and aft, and up and down. Additionally, the angle of the seat back is infinitely adjustable.

Fore and aft adjustment is made using the handle located below the center of the seat frame. To position the seat, lift the handle, slide the seat into position, release the handle and check that the seat is locked in place. To adjust the height of the seat, rotate the large crank under the right hand corner of the seat until a comfortable height is obtained. To adjust the seat back angle, pull up on the release button, located in the center front of seat, just under the seat bottom, position the seat back to the desired angle, and release the button. When the seat is not occupied, the seat back will automatically fold forward whenever the release button is pulled up.

The rear passengers' seat consists of a fixed, one piece seat bottom and a three-position, reclining back. The reclining back is adjusted by a lever located below the center of the seat frame. To adjust the seat back, raise the lever, position the seat back to the desired angle, release the lever and check that the back is locked in place.

Headrests are installed on both the front and rear seats. To adjust the headrest, apply enough pressure to it to raise or lower it to the desired level.

INTEGRATED SEAT BELT/SHOULDER HARNESS

All seat positions are equipped with integrated seat belts/shoulder harness assemblies (Refer to Figure 7-4). The design incorporates an overhead inertia reel for the shoulder portion, and a retractor assembly for the lap portion of the belt. This design allows for complete freedom of movement of the upper torso area while providing restraint in the lap belt area. In the event of a sudden deceleration, reels lock up to provide positive restraint for the user.

In the front seats, the inertia reels are located on the centerline of the upper cabin. In the rear seats, the inertia reels are located outboard of each passenger in the upper cabin.

To use the integrated seat belt/shoulder harness, grasp the link with one hand, and, in a single motion, extend the assembly and insert into the buckle. Positive locking has occurred when a distinctive "snap" sound is heard.

Proper locking of the lap belt can be verified by ensuring that the belts are allowed to retract into the retractors and the lap belt is snug and low on the waist as worn normally during flight. No more than one additional inch of belt should be able to be pulled out of the retractor once the lap belt is in place on the occupant. If more than one additional inch of belt can be pulled out of the retractor, the occupant is too small for the installed restraint system and the seat should not be occupied until the occupant is properly restrained.

Removal is accomplished by lifting the release mechanism on the buckle or by pressing the release button on the buckle and pulling out and up on the harness. Spring tension on the inertia reel will automatically stow the harness.

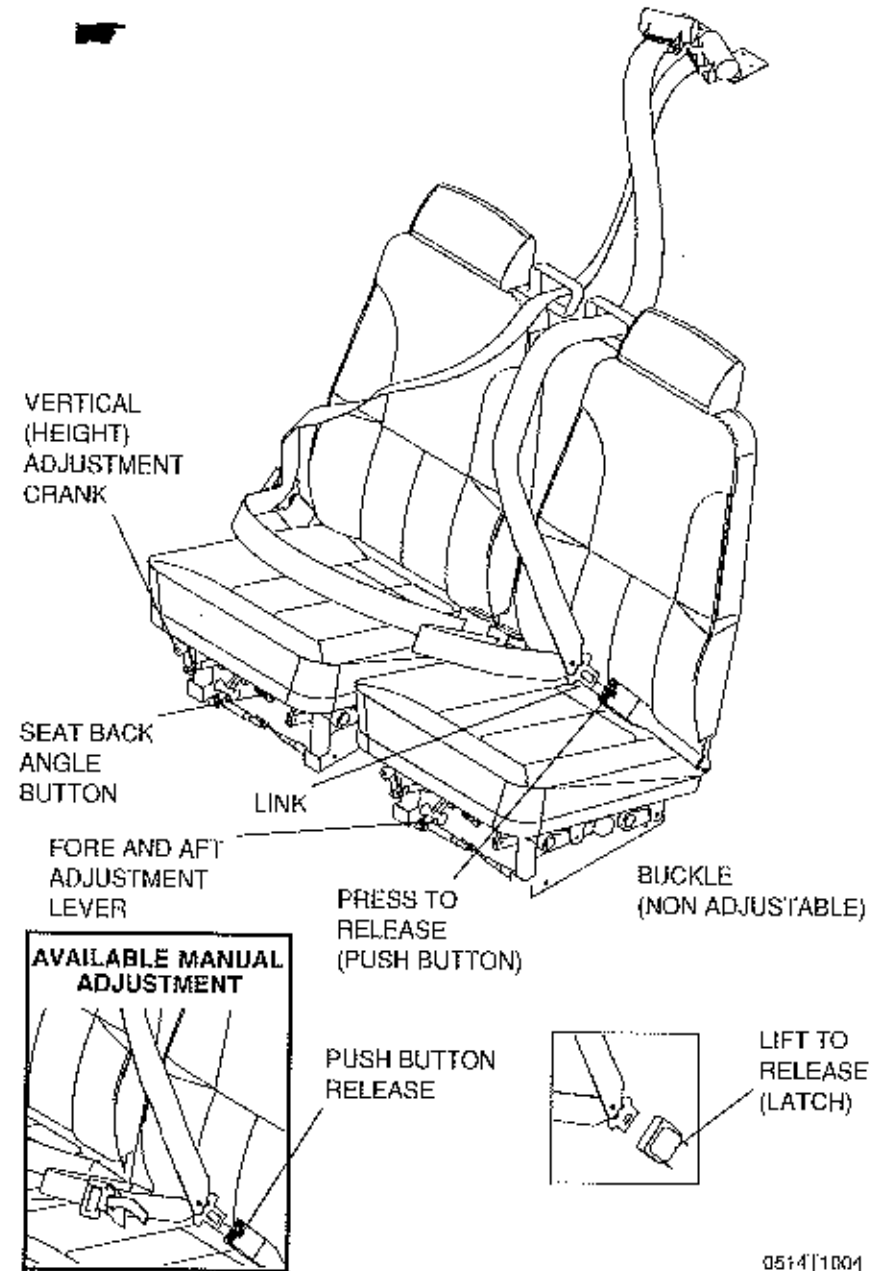

Figure 7-4. Crew Seats, Seat Belts and Shoulder Harnesses

A manually adjustable seat belt/shoulder harness assembly is available for all seats.

To use the manually adjustable seat belt/shoulder harness, fasten and adjust the seat belt/shoulder harness first. Lengthen the seat belt as required by pulling on the release strap on the belt. Snap the connecting link firmly into the buckle, then adjust to length. A properly adjusted harness will permit the occupant to lean forward enough to sit erect, but prevent excessive forward movement and contact with objects during sudden deceleration. Also, the pilot must have the freedom to reach all controls easily.

Disconnecting the manually adjustable seat belt/shoulder harness is accomplished by pushing the button on the buckle to release the connecting link.

ENTRANCE DOORS AND CABIN WINDOWS

Entry to, and exit from the airplane is accomplished through either of two entry doors, one on each side of the cabin at the front seat positions (refer to Section 6 for cabin and cabin door dimensions). The doors incorporate a recessed exterior door handle, a conventional interior door handle, a key operated door lock (left door only), a door stop mechanism, and openable windows in both the left and right doors.

NOTE

The door latch design on this model requires that the outside door handle on the pilot and front passenger doors be extended out whenever the doors are open. When closing the door, do not attempt to push the door handle in until the door is fully shut.

To open the doors from outside the airplane, utilize the recessed door handle near the aft edge of either door by grasping the forward edge of the handle and pulling outboard. To close or open the doors from inside the airplane, use the combination door handle and arm rest. The inside door handle has three positions and a placard at its base which reads OPEN, CLOSE, and LOCK. The handle is spring loaded to the CLOSE (up) position. When the door has been pulled shut and latched, lock it by rotating the door handle forward to the LOCK position (flush with the arm rest). When the handle is rotated to the LOCK position, an over center action will hold it in that position. Both cabin doors should be locked prior to flight, and should not be opened intentionally during flight.

NOTE

Accidental opening of a cabin door in flight due to improper closing does not constitute a need to land the airplane. The best procedure is to set up the airplane in a trimmed condition at approximately 75 KIAS, momentarily shove the door outward slightly, and forcefully close and lock the door.

Exit from the airplane is accomplished by rotating the door handle from the LOCK position, past the CLOSE position, aft to the OPEN position and pushing the door open. To lock the airplane, lock the right cabin door with the inside handle, close the left cabin door, and using the ignition key, lock the door.

The left and right cabin doors are equipped with openable windows which are held in the closed position by a detent equipped latch on the lower edge of the window frame. To open the windows, rotate the latch upward. Each window is equipped with a spring-loaded retaining arm which will help rotate the window outward, and hold it there. If required, either window may be opened at any speed up to 163 KIAS. The rear side windows and rear windows are of the fixed type and cannot be opened.

CONTROL LOCKS

A control lock is provided to lock the aileron and elevator control surfaces to prevent damage to these systems by wind buffeting while the airplane is parked. The lock consists of a shaped steel rod and flag. The flag identifies the control lock and cautions about its removal before starting the engine. To install the control lock, align the hole in the top of the pilot's control wheel shaft with the hole in the top of the shaft collar on the instrument panel and insert the rod into the aligned holes. Installation of the lock will secure the ailerons in a neutral position and the elevators in a slightly trailing edge down position. Proper installation of the lock will place the flag over the ignition switch. In areas where high or gusty winds occur, a control surface lock should be installed over the vertical stabilizer and rudder. The control lock and any other type of locking device should be removed prior to starting the engine.

ENGINE

The airplane is powered by a horizontally opposed, four cylinder, overhead valve, air cooled, fuel injected engine with a wet sump lubrication system. The engine is a Lycoming Model IO-360-L2A and is rated at 160 horsepower at 2400 RPM. Major accessories include a starter and belt driven alternator mounted on the front of the engine, and dual magnetos, dual vacuum pumps, and a full flow oil filter mounted on the rear of the engine accessory case.

ENGINE CONTROLS

Engine power is controlled by a throttle located on the switch and control panel above the center pedestal. The throttle is open in the full forward position and closed in the full aft position. A friction lock, which is a round knurled knob, is located at the base of the throttle and is operated by rotating the lock clockwise to increase friction or counterclockwise to decrease it.

The mixture control, mounted adjacent to the throttle control, is a red knob with raised points around the circumference and is equipped with a lock button in the end of the knob. The rich position is full forward, and full aft is the idle cutoff position. For small adjustments, the control may be moved forward by rotating the knob clockwise, and aft by rotating the knob counterclockwise. For rapid or large adjustments, the knob may be moved forward or aft by depressing the lock button in the end of the control, and then positioning the control as desired.

ENGINE INSTRUMENTS

Engine operation is monitored by the following instruments: oil pressure/oil temperature indicator, tachometer and exhaust gas temperature (EGT) indicator. In addition, the annunciator panel contains a red OIL PRESS annunciator which comes on when the oil pressure is low.

See Section 2, Limitations, for engine operating limitations and instrument markings.

Oil pressure signals are generated from an oil pressure line/transducer combination. An oil pressure line is routed from the upper front of the engine case to the rear engine baffle. At the baffle, the oil pressure line is connected to a transducer. This transducer produces an electrical signal which is translated into a pressure reading by the oil pressure gage located on the LH instrument panel.

In addition, a separate low oil pressure indication is provided through the panel annunciator. This annunciator is wired to a pressure switch located on the rear of the engine accessory case. When oil pressure is below 20 PSI, the switch grounds and completes the annunciator circuit, illuminating the red OIL PRESS light. When pressure exceeds 20 PSI, the ground is removed and the OIL PRESS annunciator goes out.

NOTE

The low oil pressure switch is also connected to the hour (Hobbs) meter. When pressure exceeds 20 PSI, a ground is supplied to the hour meter, completing the hour meter circuit.

Oil temperature signals are generated from a resistance-type probe located in the engine accessory case. As oil temperature changes, the probe resistance changes. This resistance is translated into oil temperature readings on the cockpit indicator.

The engine driven mechanical tachometer is located on the instrument panel to the right of the pilot's control wheel. The instrument is calibrated in increments of 100 RPM and indicates both engine and propeller speed. An hour meter in the lower section of the dial records elapsed engine time in hours and tenths. Instrument markings include the normal operating range (green arc) from 1900 to 2400 RPM.

The exhaust gas temperature (EGT) indicator is located on the LH instrument panel as part of the EGT/Fuel Flow indicator. Since exhaust gas temperature varies with fuel-air ratio (mixture), density altitude, throttle position and RPM, the instrument is a useful aid in adjusting the mixture for best economy or performance. The EGT indicator allows the pilot to lean (reduce the proportion of fuel in the fuel-air mixture) to a known value using the maximum or "peak" exhaust gas temperature as a reference. An index pointer which can be positioned manually is provided for the pilot to mark the location of the peak. **Never lean using EGT when operating at more than 80% power.**

The EGT system uses a thermocouple in the in the engine exhaust (tailpipe) to supply a voltage proportional to exhaust gas temperature. The EGT indicator responds to the voltage developed by the thermocouple. As the mixture is leaned (from full rich), the exhaust gas temperature will increase to a maximum value as the stoichiometric (most chemically efficient) fuel-air ratio is achieved and will decrease if the mixture continues to be leaned.

NEW ENGINE BREAK-IN AND OPERATION

The engine underwent a run in at the factory and is ready for the full range of use. It is, however, suggested that cruising be accomplished at 80% power as much as practicable until a total of 50 hours has accumulated or oil consumption has stabilized. This will ensure proper seating of the rings.

ENGINE LUBRICATION SYSTEM

The engine utilizes a full pressure, wet sump-type lubrication system with aviation grade oil used as the lubricant. The capacity of the engine sump (located on the bottom of the engine) is eight quarts. Oil is drawn from the sump through an oil suction strainer screen into the engine-driven oil pump. From the pump, oil is routed to a bypass valve. If the oil is cold, the bypass valve allows the oil to bypass the oil cooler and go directly from the pump to the full flow oil filter. If the oil is hot, the bypass valve routes the oil out of the accessory housing and into a flexible hose leading to the oil cooler on the right, rear engine baffle. Pressure oil from the cooler returns to the accessory housing where it passes through the full flow oil filter. The filter oil then enters a pressure relief valve which regulates engine oil pressure by allowing excessive oil to return to the sump while the balance of the oil is circulated to various engine parts for lubrication. Residual oil is returned to the sump by gravity flow.

An oil filler cap/oil dipstick is located at the right rear of the engine. The filler cap/ dipstick is accessible through an access door on the top right side of the engine cowling. The engine should not be operated on less than five quarts of oil. For extended flight, fill to eight quarts (dipstick indication only). For engine oil grade and specifications, refer to Section 8 of this handbook.

IGNITION AND STARTER SYSTEM

Engine ignition is provided by two engine-driven magnetos, and two spark plugs in each cylinder. The right magneto fires the lower right and upper left spark plugs, and the left magneto fires the lower left and upper right spark plugs. Normal operation is conducted with both magnetos due to the more complete burning of the fuel/air mixture with dual ignition.

Ignition and starter operation is controlled by a rotary-type switch located on the left switch and control panel. The switch is labeled clockwise, OFF, R, L, BOTH, and START. The engine should be operated on both magnetos (BOTH position) except for magneto checks. The R and L positions are for checking purposes and emergency use only. When the switch is rotated to the spring loaded START position, (with the master switch in the ON position), the starter contactor is closed and the starter, now energized, will crank the engine. When the switch is released, it will automatically return to the BOTH position.

AIR INDUCTION SYSTEM

The engine air induction system receives ram air through an intake on the lower front portion of the engine cowling. The intake is covered by an air filter which removes dust and other foreign matter from the induction air. Airflow passing through the filter enters an air box. The air box has a spring-loaded alternate air door. If the air induction filter should become blocked, suction created by the engine will open the door and draw unfiltered air from inside the lower cowl area. An open alternate air door will result in an approximate 10% power loss at full throttle. After passing through the air box, induction air enters a fuel/air control unit under the engine, and is then ducted to the engine cylinders through intake manifold tubes.

EXHAUST SYSTEM

Exhaust gas from each cylinder passes through riser assemblies to a muffler and tailpipe. Outside air is pulled in around shrouds which are constructed around the outside of the muffler to form heating chambers which supply heat to the cabin.

COOLING SYSTEM

Ram air for engine cooling enters through two intake openings in the front of the engine cowling. The cooling air is directed around the cylinders and other areas of the engine by baffling, and is then exhausted through an opening at the bottom aft edge of the cowling. No manual cowl flap cooling system control is required.

PROPELLER

The airplane is equipped with a two-bladed, fixed-pitch, one-piece forged aluminum alloy propeller which is anodized to retard corrosion. The propeller is 75 inches in diameter.

FUEL SYSTEM

The airplane fuel system (see Figure 7-6) consists of two vented integral fuel tanks (one tank in each wing), a three-position selector valve, auxiliary fuel pump, fuel shutoff valve, fuel strainer, engine driven fuel pump, fuel/air control unit, fuel distribution valve and fuel injection nozzles.

WARNING

UNUSABLE FUEL LEVELS FOR THIS AIRPLANE WERE DETERMINED IN ACCORDANCE WITH FEDERAL AVIATION REGULATIONS. FAILURE TO OPERATE THE AIRPLANE IN COMPLIANCE WITH FUEL LIMITATIONS SPECIFIED IN SECTION 2 MAY FURTHER REDUCE THE AMOUNT OF FUEL AVAILABLE IN FLIGHT.

| FUEL TANKS | FUEL LEVEL (QUANTITY EACH TANK) | TOTAL FUEL | TOTAL UNUSABLE | TOTAL USABLE ALL FLIGHT CONDITIONS |
|------------|---------------------------------|------------|----------------|------------------------------------|
| Two | Full (28.0) | 56.0 | 3.0 | 53.0 |

Figure 7-5. Fuel Quantity Data in U.S. Gallons

FUEL DISTRIBUTION

Fuel flows by gravity from the two wing tanks to a three-position selector valve, labeled BOTH, RIGHT and LEFT and on to the reservoir tank. From the reservoir tank fuel flows through the auxiliary fuel pump, past the fuel shutoff valve, through the fuel strainer to an engine driven fuel pump.

From the engine driven fuel pump, fuel is delivered to the fuel/air control unit, where it is metered and directed to a fuel distribution valve (manifold) which distributes it to each cylinder. Fuel flow into each cylinder is continuous, and flow rate is determined by the amount of air passing through the fuel/air control unit.

Starting at serial number 17281188 and on, and airplanes incorporating MK172-28-01, a fuel return system was added to promote smooth engine operation on the ground during hot weather. The return system carries a metered amount of fuel from the engine fuel-air control unit to the fuel reservoir tank. The increased fuel flow due to the return system, results in lower fuel temperatures at the engine inlet and helps to minimize the amount of fuel vapor generated in the fuel lines during high OAT operations.

FUEL INDICATING

Fuel quantity is measured by two float type fuel quantity transmitters (one in each tank) and indicated by an electrically operated fuel quantity indicator on the left side of the instrument panel. The gauges are marked in gallons of fuel. An empty tank is indicated by a red line and the number 0. When an indicator shows an empty tank, approximately 1.5 gallons remain in each tank as unusable fuel. The indicators should not be relied upon for accurate readings during skids, slips, or unusual attitudes.

Each fuel tank also incorporates warning circuits which can detect low fuel conditions and erroneous transmitter messages. Anytime fuel in the tank drops below approximately 5 gallons (and remains below this level for more than 60 seconds), the amber LOW FUEL message will flash on the annunciator panel for approximately 10 seconds and then remain steady amber. The annunciator cannot be turned off by the pilot. If the left tank is low, the message will read L LOW FUEL. If the right tank is low, the message will read LOW FUEL R. If both tanks are low, the message will read L LOW FUEL R.

In addition to low fuel annunciation, the warning circuitry is designed to report failures with each transmitter caused by shorts, opens or transmitter resistance which increases over time. If the circuitry detects any one of these conditions, the fuel level indicator needle will go to the OFF position (below the 0 mark on the fuel indicator), and the amber annunciator will illuminate. If the left tank transmitter has failed, the message will read L LOW FUEL. If the right tank transmitter has failed, the message will read LOW FUEL R. If both tanks transmitters have failed, the message will read L LOW FUEL R.

Fuel pressure is measured by use of a transducer mounted near the fuel manifold. This transducer produces an electrical signal which is translated for the cockpit-mounted indicator in gallons-per-hour.

FUEL VENTING

Fuel system venting is essential to system operation. Blockage of the system will result in decreasing fuel flow and eventual engine stoppage. Venting is accomplished by an interconnecting line from the right fuel tank to the left tank. The left fuel tank is vented overboard through a vent line, equipped with a check valve, which protrudes from the bottom surface of the left wing near the wing strut. Both fuel filler caps are also vented.

REDUCED TANK CAPACITY

The airplane may be serviced to a reduced capacity to permit heavier cabin loadings. This is accomplished by filling each tank to the bottom edge of the fuel filler tab, thus giving a reduced fuel load of 17.5 gallons usable in each tank.

FUEL SELECTOR VALVE

The fuel selector valve should be in the BOTH position for takeoff, climb, landing, and maneuvers that involve prolonged slips or skids of more than 30 seconds. Operation from either LEFT or RIGHT tank is reserved for cruising flight.

NOTE

When the fuel selector valve handle is in the BOTH position in cruising flight, unequal fuel flow from each tank may occur if the wings are not maintained exactly level. Resulting wing heaviness can be alleviated gradually by turning the selector valve handle to the tank in the "heavy" wing. It is not practical to measure the time required to consume all of the fuel in one tank, and, after switching to the opposite tank, expect an equal duration from the remaining fuel. The airspace in both fuel tanks is interconnected by a vent line and, therefore, some sloshing of fuel between tanks can be expected when the tanks are nearly full and the wings are not level.

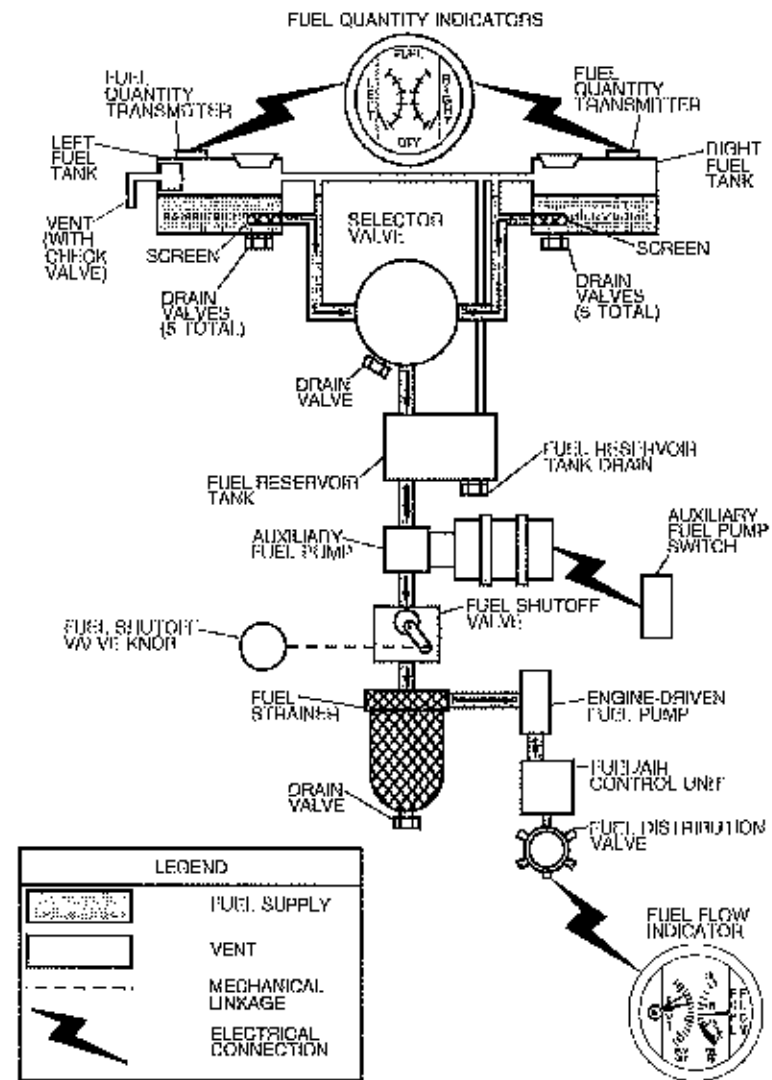

058501013

Figure 7-6. Fuel System Schematic
(Sheet 1 of 2)
17280001 thru 17281187



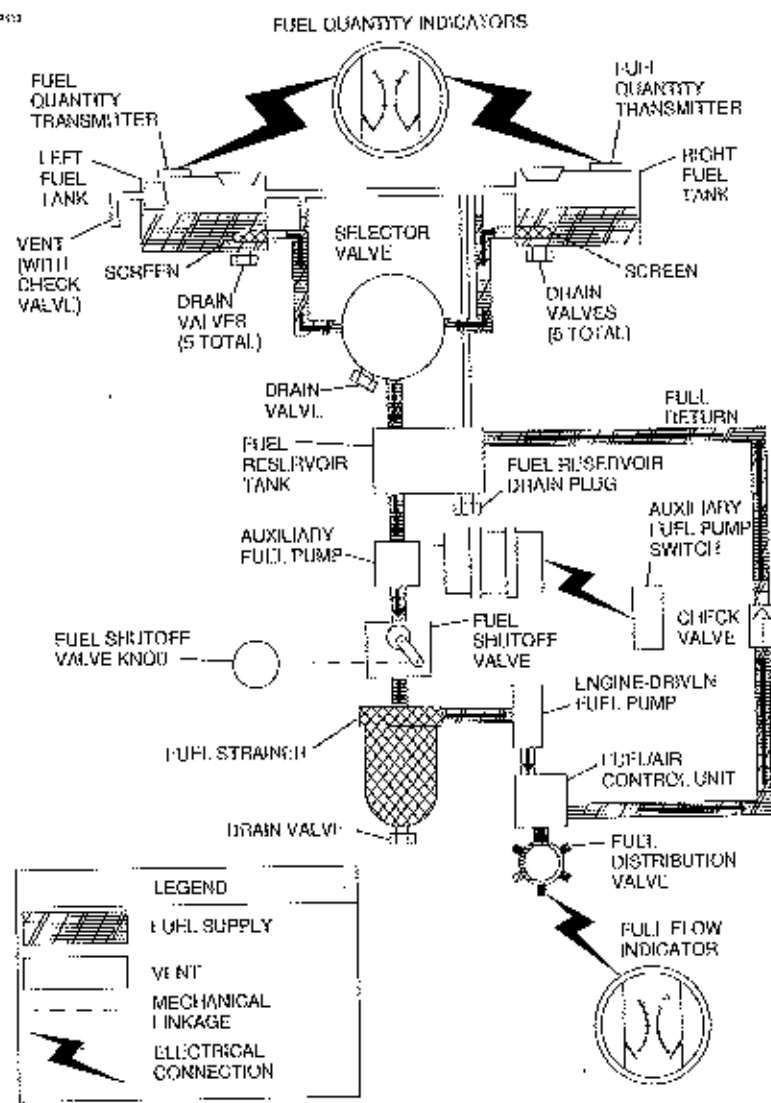

Figure 7-6. Fuel System Schematic
(Sheet 2 of 2)
17281188 and On
And airplanes incorporating MK172-28-01.

NOTE

When the fuel tanks are 1/4 full or less, prolonged uncoordinated flight such as slips or skids can uncover the fuel tank outlets. Therefore, if operating with one fuel tank dry or if operating on LEFT or RIGHT tank when 1/4 full or less, do not allow the airplane to remain in uncoordinated flight for periods in excess of 30 seconds.

FUEL DRAIN VALVES

The fuel system is equipped with drain valves to provide a means for the examination of fuel in the system for contamination and grade. The system should be examined before each flight and after each refueling, by using the sampler cup provided to drain fuel from each wing tank sump and the fuel strainer sump. If any evidence of fuel contamination is found, it must be eliminated in accordance with the Preflight Inspection checklist and the discussion in Section 8 of this publication. If takeoff weight limitations for the next flight permit, the fuel tanks should be filled after each flight to prevent condensation.

BRAKE SYSTEM

The airplane has a single-disc, hydraulically actuated brake on each main landing gear wheel. Each brake is connected, by a hydraulic line, to a master cylinder attached to each of the pilot's rudder pedals. The brakes are operated by applying pressure to the top of either the left (pilot's) or right (copilot's) set of rudder pedals, which are interconnected. When the airplane is parked, both main wheel brakes may be set by utilizing the parking brake which is operated by a handle under the left side of the instrument panel. To apply the parking brake, set the brakes with the rudder pedals, pull the handle aft, and rotate it 90° down.

For maximum brake life, keep the brake system properly maintained, and minimize brake usage during taxi operations and landings.

Some of the symptoms of impending brake failure are: gradual decrease in braking action after brake application, noisy or dragging brakes, soft or spongy pedals, and excessive travel and weak braking action. If any of these symptoms appear, the brake system is in need of immediate attention. If, during taxi or landing roll, braking action decreases, let up on the pedals and then reapply the brakes with heavy pressure. If the brakes become spongy or pedal travel increases, pumping the pedals should build braking pressure. If one brake becomes weak or fails, use the other brake sparingly while using opposite rudder, as required, to offset the good brake.

ELECTRICAL SYSTEM

The airplane is equipped with a 28-volt, direct current electrical system (Refer to Figure 7-7). The system is powered by a belt-driven, 60-amp alternator and a 24-volt battery, located on the left forward side of the firewall. Power is supplied to most general electrical circuits through a split primary bus bar, with an essential bus wired between the two primaries to provide power for the master switch, annunciator circuits and interior lighting.

Each primary bus bar is also connected to an avionics bus bar via a single avionics master switch. The primary buses are on anytime the master switch is turned on, and are not affected by starter or external power usage. The avionics buses are on when the master switch and avionics master switch are in the ON position.

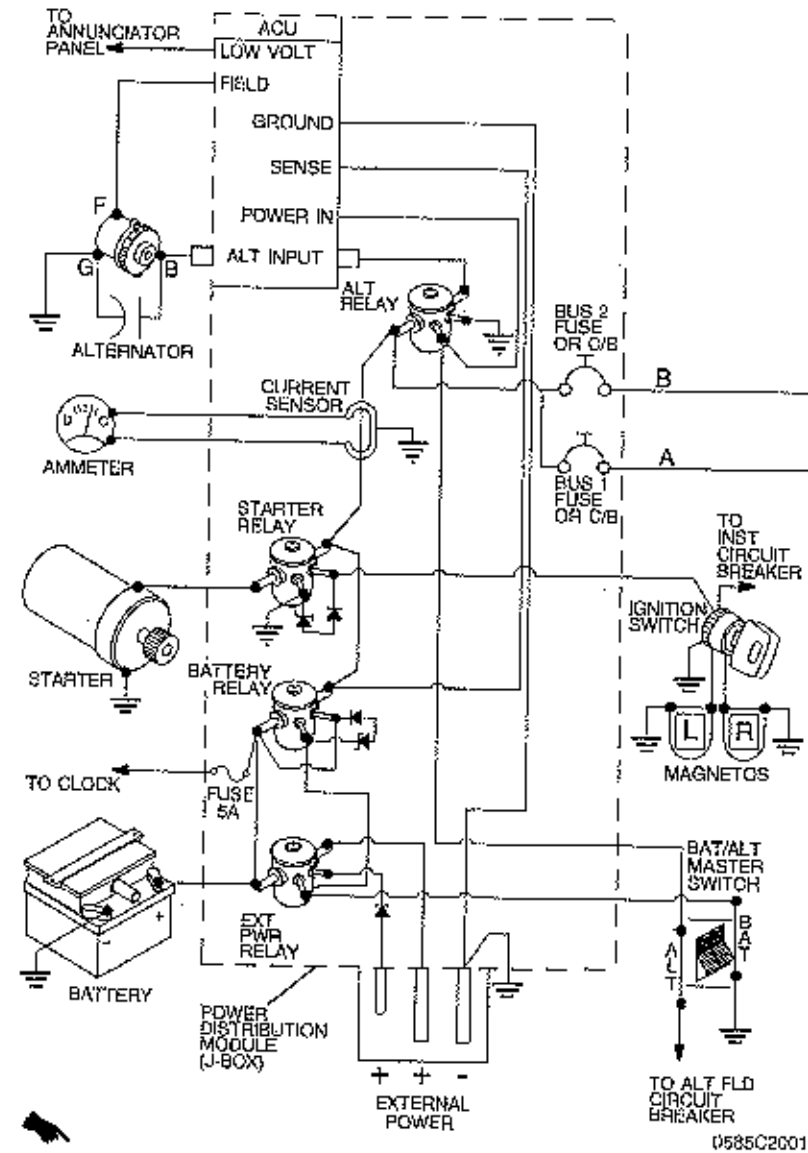

Figure 7-7. Electrical Schematic (Serials 17280001 thru 17280983)
(Sheet 1 of 2)

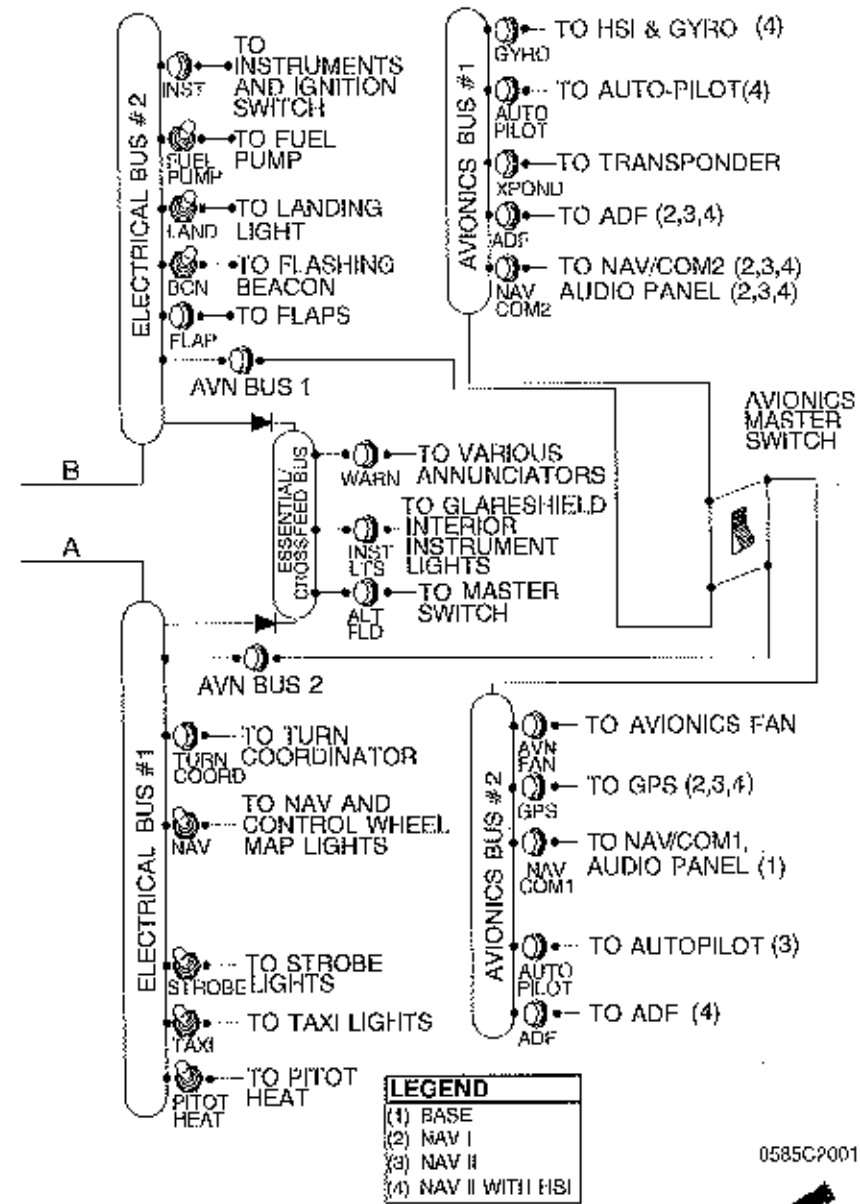

Figure 7-7. Electrical Schematic (Serials 17280001 thru 17280983)
(Sheet 2 of 2)

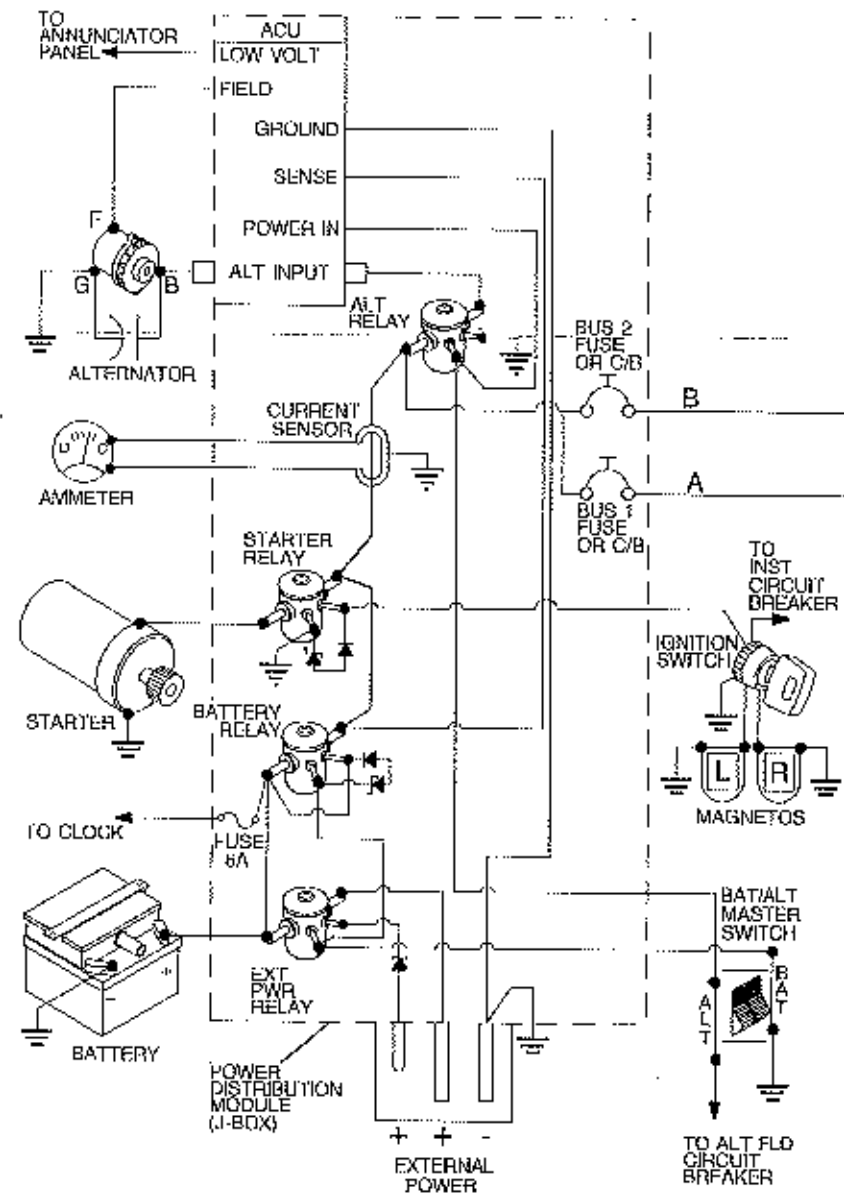

Figure 7-7A. Electrical Schematic
(Serials 17280984 and On)(Sheet 1 of 2)

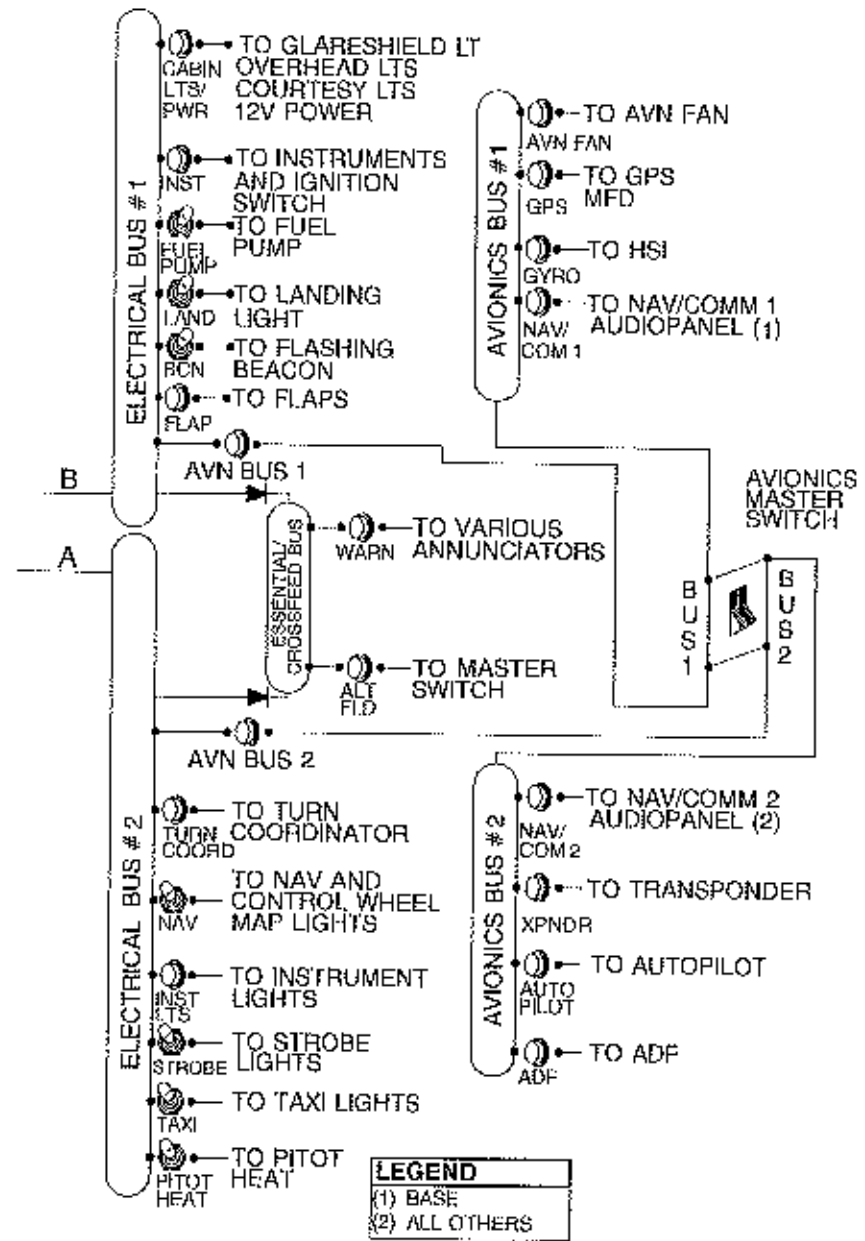

Figure 7-7A. Electrical Schematic (Serials 17280984 and On)
(Sheet 1 of 2)

The airplane uses a power distribution module (J-Box), located on the left forward side of the firewall, to house all relays used throughout the airplane electrical system. In addition, the alternator control unit and the external power connector are housed within the module.

ANNUNCIATOR PANEL

An annunciator panel (with integral toggle switch) is located on the left side of the instrument panel and provides caution (amber) and warning (red) messages for selected portions of the airplane systems. The annunciator is designed to flash messages for approximately 10 seconds to gain the attention of the pilot before changing to steady on. The annunciator panel cannot be turned off by the pilot.

Inputs to the annunciator come from each fuel transmitter, the low oil pressure switch, the vacuum transducers and the alternator control unit (ACU). Individual LED bulbs illuminate each message and may be replaced through the rear of the annunciator. Illumination intensity can be controlled by placing the toggle switch in either the DIM or BRT positions (earlier serial number airplanes) or the DAY or NIGHT positions (later serial number airplanes).

The annunciator panel can be tested by placing the Master switch in the ON position and holding the annunciator panel test switch in the TST (earlier serial number airplanes) or the TEST (later serial number airplanes) position. All amber and red messages will flash until the switch is released.

NOTE

When the Master switch is turned ON, some annunciators will flash for approximately 10 seconds before illuminating steadily. When the annunciator panel test switch is held in the TST (earlier serial number airplanes) or the TEST (later serial number airplanes) position, all remaining lights will flash until the switch is released.

MASTER SWITCH

The master switch is a split rocker type switch labeled MASTER, and is ON in the up position and OFF in the down position. The right half of the switch, labeled BAT, controls all electrical power to the airplane. The left half, labeled ALT, controls the alternator.

CAUTION

PRIOR TO TURNING THE MASTER SWITCH ON OR OFF, STARTING THE ENGINE OR APPLYING AN EXTERNAL POWER SOURCE, THE AVIONICS MASTER SWITCH SHOULD BE TURNED OFF TO PREVENT ANY HARMFUL TRANSIENT VOLTAGE FROM DAMAGING THE AVIONICS EQUIPMENT.

Normally, both sides of the master switch should be used simultaneously; however, the BAT side of the switch could be turned on separately to check equipment while on the ground. To check or use avionics equipment or radios while on the ground, the avionics master switch must also be turned on. The ALT side of the switch, when placed in the OFF position, removes the alternator from the electrical system. With this switch in the OFF position, the entire electrical load is placed on the battery. Continued operation with the alternator switch in the OFF position will reduce battery power low enough to open the battery contactor, remove power from the alternator field, and prevent alternator restart.

AVIONICS MASTER SWITCH

Electrical power for each Avionics Bus is supplied from a primary Electrical Bus. For airplane serial numbers 17280001 through 17280983, except for certain non-U.S. certified airplanes, both Avionics Buses are controlled by a single-section rocker-type Avionics Master switch. At serial number 17280984 and on, a two-section or "split" rocker-type Avionics Master switch controls power to each Avionics Bus independently. Placing the rocker in the up (ON) position provides power to the Avionics Bus. Placing the rocker in the down (OFF) position removes power from the Avionics Bus. The Avionics Master switch is located on the lower left side of the instrument panel.

NOTE

For airplane serial numbers 17280001 through 17280983, aircraft certified outside the United States can have a two-section or "split" Avionics Master switch. The two-section Avionics Master switch enables independent operation of Avionics Bus 1 and Avionics Bus 2.

With the Avionics Master rocker in the OFF position, no electrical power is provided to the avionics, even when the Master switch or the individual avionics component equipment switches are in their ON positions. The Avionics Master switch (both sides, if two-section) should be placed in the OFF position before switching the Master switch ON or OFF, starting the engine, or applying an external power source.

Each avionics bus also incorporates a separate circuit breaker installed between the primary bus and the avionics master switch. In the event of an electrical malfunction, this breaker will trip and take the effected avionics bus off-line.

AMMETER

The ammeter/vacuum gage is located on the lower left side of the instrument panel. It indicates the amount of current, in amperes, from the alternator to the battery or from the battery to the airplane electrical system. When the engine is operating and the master switch is turned on, the ammeter indicates the charging rate applied to the battery. In the event the alternator is not functioning or the electrical load exceeds the output of the alternator, the ammeter indicates the battery discharge rate.

LOW VOLTAGE ANNUNCIATION

The low voltage warning annunciator is incorporated in the annunciator panel and activates when voltage falls below 24.5 volts. If low voltage is detected, the red annunciation VOLTS will flash for approximately 10 seconds before illuminating steadily. The pilot cannot turn off the annunciator.

In the event an overvoltage condition occurs, the alternator control unit automatically opens the ALT FLD circuit breaker, removing alternator field current and shutting off the alternator. The battery will then supply system current as shown by a discharge rate on the ammeter. Under these conditions, depending on electrical system load, the low voltage warning annunciator will illuminate when system voltage drops below normal. The alternator control unit may be reset by resetting the circuit breaker. If the low voltage warning annunciator extinguishes, normal alternator charging has resumed; however, if the annunciator illuminates again, a malfunction has occurred, and the flight should be terminated as soon as practical.

NOTE

Illumination of the low voltage annunciator and ammeter discharge indications may occur during low RPM conditions with an electrical load on the system, such as during a low RPM taxi. Under these conditions, the light will go out at higher RPM.

CIRCUIT BREAKERS AND FUSES

All circuit breakers inside the airplane are of the "push to reset" or "switch/breaker" type. The power distribution module (J-Box) uses either "push to reset" circuit breakers or spade type (automotive style) fuses. One glass type fuse is also used to provide power to the clock.

On aircraft using spade type fuses in the power distribution module (J-Box), a spare fuse is also included. If the spare fuse is used, a replacement spare should be obtained and reinstalled before the next flight.

EXTERNAL POWER RECEPTACLE

An external power receptacle is integral to the power distribution module and allows the use of an external electrical power source for cold weather starting, and during lengthy maintenance work on electrical and avionics equipment. The receptacle is located on the left side of the engine cowling, just forward of the firewall and midway up the side. Access to the receptacle is gained by removing the cover plate (earlier serial number airplanes) or opening the hinged access door (later serial number airplanes).

The power distribution module (J-Box) incorporates a circuit which will close the battery contactor when external power is applied through the ground service plug receptacle with the master switch turned on. This feature is intended as a servicing aid when battery power is too low to close the contactor, and should not be used to avoid performing proper maintenance procedures on a low battery.

NOTE

- If no avionics equipment is to be used or serviced, the avionics master switch should be in the OFF position. If maintenance is required on the avionics equipment, use a regulated external power source to prevent damage to the avionics equipment by transient voltage. Do not crank or start the engine with the avionics master switch in the ON position.
- Before connecting an external power source (generator type or battery cart), the avionics master switch and the master switch should be turned off.

LIGHTING SYSTEMS

EXTERIOR LIGHTING

Exterior lighting consists of navigation lights on the wing tips and top of the rudder, a dual landing/taxi light configuration located in the left wing leading edge, a flashing beacon mounted on top of the vertical fin, and a strobe light on each wing tip. In addition, two courtesy lights are recessed into the lower surface of each wing and provide illumination for each cabin door area.

The exterior courtesy lights (and the rear cabin dome light) are turned on by pressing the rear cabin light switch. Pressing the rear cabin light switch again will extinguish the three lights. The remaining exterior lights are operated by breaker/switches located on the lower left instrument panel. To activate these lights, place switch in the UP position. To deactivate light, place in the DOWN position.

NOTE

The strobes and flashing beacon should not be used when flying through clouds or overcast; the flashing light reflected from water droplets or particles in the atmosphere, particularly at night, can produce vertigo and loss of orientation.

INTERIOR LIGHTING

Interior lighting is controlled by a combination of flood lighting, glare shield lighting, pedestal lighting, panel lighting, radio lighting and pilot control wheel lighting.

Flood lighting is accomplished using two lights in the front and a single dome light in the rear. All flood lights are contained in the overhead console, and are turned on and off with push type switches located near each light. The two front lights are individually rotatable, providing directional lighting for the pilot and front passenger. The rear dome light is a fixed position light and provides for general illumination in the rear cabin area.

Glareshield lighting is provided by either a fluorescent light or a series of LED lights recessed into the lower surface of the glareshield. This light is controlled by rotating the GLARESHIELD LT dimmer, located below the nav indicators. Rotating the dimmer clockwise increases light intensity, and rotating the dimmer counterclockwise decrease light intensity.

Pedestal lighting consists of a single, hooded light located above the fuel selector. This light is controlled by rotating the PEDESTAL LT dimmer, located below the nav indicators. Rotating the dimmer clockwise increases light intensity, and rotating the dimmer counterclockwise decreases light intensity.

Panel lighting is accomplished using individual lights mounted in each instrument and gauge. These lights are wired in parallel and are controlled by the PANEL LT dimmer, located below the nav indicators. Rotating the dimmer clockwise increases light intensity, and rotating the dimmer counterclockwise decreases light intensity.

Pilot control wheel lighting is accomplished by use of a rheostat and light assembly, located underneath the pilot control wheel. The light provides downward illumination from the bottom of the control wheel to the pilot's lap area. To operate the light, first turn on the NAV light switch, then adjust the map light intensity with the knurled rheostat knob. Rotating the dimmer clockwise increases light intensity, and rotating the dimmer counterclockwise decreases light intensity.

In addition to the RADIO LT dimmer, lighting intensity for the avionics displays and the NAV indicators (pilot's panel) is controlled by the annunciator panel test switch. When the switch is in the BRT position (earlier serial number airplanes) or the DAY position (later serial number airplanes), this lighting may be off regardless of the RADIO LT dimmer position.

Regardless of the light system in question, the most probable cause of a light failure is a burned out bulb. However, in the event any of the lighting systems fail to illuminate when turned on, check the appropriate circuit breaker. If the circuit breaker has opened, and there is no obvious indication of a short circuit (smoke or odor), turn off the light switch of the affected light, reset the breaker, and turn the switch on again. If the breaker opens again, do not reset it.

CABIN HEATING, VENTILATING AND DEFROSTING SYSTEM

The temperature and volume of airflow into the cabin can be regulated by manipulation of the push-pull CABIN HT and CABIN AIR controls (Refer to Figure 7-8). Both controls are the double-button locking type and permit intermediate settings.

For cabin ventilation, pull the CABIN AIR knob out. To raise the air temperature, pull the CABIN HT knob out approximately 1/4 to 1/2 inch for a small amount of cabin heat. Additional heat is available by pulling the knob out farther; maximum heat is available with the CABIN HT knob pulled out and the CABIN AIR knob pushed full in. When no heat is desired in the cabin, the CABIN HT knob is pushed full in.

Front cabin heat and ventilating air is supplied by outlet holes spaced across a cabin manifold just forward of the pilot's and copilot's feet. Rear cabin heat and air is supplied by two ducts from the manifold, one extending down each side of the cabin to an outlet just aft of the rudder pedals at floor level. Windshield defrost air is also supplied by two ducts leading from the cabin manifold to defroster outlets near the lower edge of the windshield. Two knobs control sliding valves in either defroster outlet to permit regulation of defroster airflow.

Separate adjustable ventilators supply additional air; one near each upper corner of the windshield supplies air for the pilot and copilot, and two ventilators are available for the rear cabin area to supply air to the rear seat passengers. There are additional ventilators located in various positions in the cockpit.

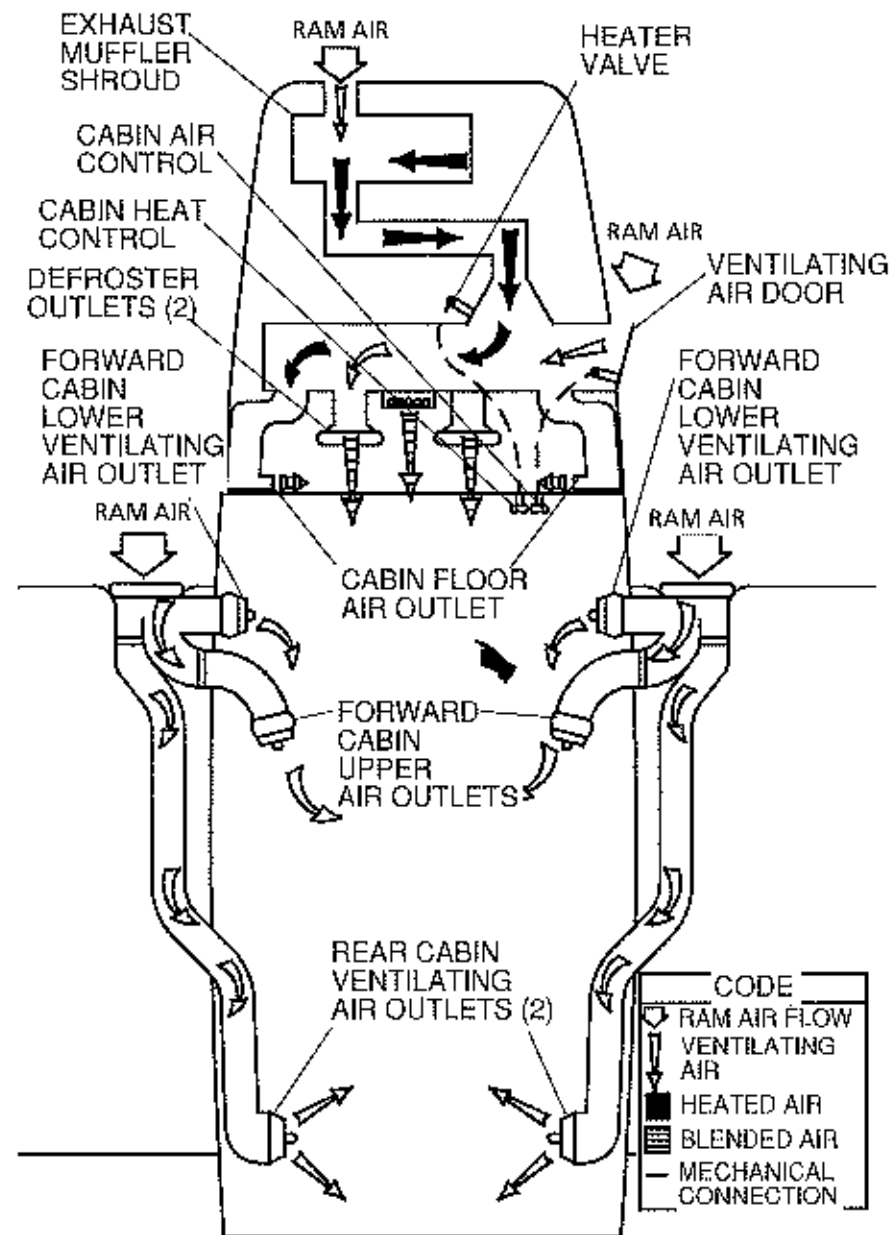

0585C1015

Figure 7-8. Cabin Heating, Ventilating and Defrosting System.

PITOT-STATIC SYSTEM AND INSTRUMENTS

The pitot-static system supplies ram air pressure to the airspeed indicator and static pressure to the airspeed indicator, vertical speed indicator and altimeter. The system is composed of a heated pitot tube mounted on the lower surface of the left wing, an external static port on the lower left side of the forward fuselage, and the associated plumbing necessary to connect the instruments to the sources.

The heated pitot system consists of a heating element in the pitot tube, a 5-amp switch/breaker labeled PITOT HEAT, and associated wiring. The switch/breaker is located on the lower left side of the instrument panel. When the pitot heat switch is turned on, the element in the pitot tube is heated electrically to maintain proper operation in possible icing conditions.

A static pressure alternate source valve is installed below the throttle, and can be used if the external static source is malfunctioning. This valve supplies static pressure from inside the cabin instead of the external static port.

If erroneous instrument readings are suspected due to water or ice in the pressure line going to the standard external static pressure source, the alternate static source valve should be pulled on.

Pressures within the cabin will vary with open heater/vents and windows. Refer to Section 5 for the effect of varying cabin pressures on airspeed readings.

AIRSPPEED INDICATOR

The airspeed indicator is calibrated in knots. It incorporates a true airspeed window which allows true airspeed to be read off the face of the dial. In addition, the indicator incorporates a window at the twelve o'clock position. The window displays true airspeed, and the window at the twelve o'clock position displays pressure altitude overlaid with a temperature scale.

Limitation and range markings (in KIAS) include the white arc (33 to 85 knots), green arc (44 to 129 knots), yellow arc (129 to 163 knots), and a red line (163 knots).

To find true airspeed, first determine pressure altitude and outside air temperature. Using this data, rotate the lower left knob until pressure altitude aligns with outside air temperature in the twelve o'clock window. True airspeed (corrected for pressure and temperature) can now be read in the lower window.

VERTICAL SPEED INDICATOR

The vertical speed indicator depicts airplane rate of climb or descent in feet per minute. The pointer is actuated by atmospheric pressure changes resulting from changes of altitude as supplied by the static source.

SAFETY WARNING



Vacuum/Pressure Gyroscopic Flight Instrument System

ATTENTION: MECHANIC/SERVICE FACILITY

This important notice must be given to the Owner/Operator of the aircraft into which this air pump is installed. FAILURE TO DO SO MAY RESULT IN DEATH, BODILY INJURY, OR PROPERTY DAMAGE.

ATTENTION: AIRCRAFT OWNER/OPERATOR

This important notice must be (1) read and understood and followed before operating the aircraft into which this air pump is installed, (2) distributed to all pilots using the aircraft, and (3) permanently retained in the Pilot's Operating Handbook for this aircraft. FAILURE TO DO SO MAY RESULT IN DEATH, BODILY INJURY, OR PROPERTY DAMAGE.



Parker Hannifin Corporation
Airborne Division
711 Taylor St.
P.O. Box 4032
Elyria, Ohio 44036 USA
(440) 284-6300

Subject: SAFETY WARNING - Vacuum/Pressure Gyroscopic Flight Instrument Power System.

Applicability: This document communicates safety warning information concerning aircraft using air pumps to power gyro flight instruments while flying Instrument Flight Rules (IFR).

WARNING: FAILURE TO FOLLOW THE FOLLOWING INSTRUCTIONS MAY RESULT IN DEATH, BODILY INJURY, OR PROPERTY DAMAGE:

1. A BACK-UP PNEUMATIC POWER SOURCE FOR THE AIR DRIVEN GYROS, OR A BACK-UP ELECTRIC ATTITUDE GYRO INSTRUMENT, MUST BE INSTALLED IN ALL AIRCRAFT WHICH FLY IFR.
2. ANY INOPERATIVE AIR PUMP OR OTHER COMPONENT OF THE GYRO SYSTEM, AND ANY INOPERATIVE BACK-UP SYSTEM OR COMPONENT, MUST BE REPLACED PRIOR TO THE NEXT FLIGHT.
3. THIS PILOT SAFETY WARNING MUST BE PERMANENTLY RETAINED IN THE PILOT'S OPERATING HANDBOOK FOR THE AIRCRAFT INTO WHICH THIS AIR PUMP IS INSTALLED.

Explanation: Failure of the air pump or any other component of the pneumatic system during IFR flight in Instrument Meteorological Conditions (IMC) can lead to spatial disorientation of the pilot and subsequent loss of aircraft control. This could result in an accident causing death, bodily injury, or property damage.

Use of single-engine aircraft in IMC is increasing. Many single-engine aircraft do not have a back-up pneumatic power source or back-up electric attitude gyro instruments. In aircraft without such back-up devices, the pilot due to added workload may not be able to fly the aircraft with only "partial panel" instruments (that is, turn and slip indicator, altimeter, and airspeed indicator) in the event of primary air pump or pneumatic system failure during IMC.

Air pump or pneumatic system failures can and do occur without warning. This can be a result of various factors, including but not limited to normal wear-out of components, improper installation or maintenance, premature failure, or use of substandard overhauled components. It is recommended that an annunciator light or other device be installed to warn the pilot of loss of gyro power so that the pilot can take corrective action prior to the loss of correct gyro information.

Since air pump life cannot be accurately predicted and air pumps can fail without warning, the instructions set forth in this document must be followed.

ALTIMETER

Airplane altitude is depicted by a barometric type altimeter. A knob near the lower left portion of the indicator provides adjustment of the instrument's barometric scale to the current altimeter setting.

VACUUM SYSTEM AND INSTRUMENTS

The vacuum system (Refer to Figure 7-9) provides suction necessary to operate the attitude indicator and the directional indicator. The system consists of two engine-driven vacuum pumps, two pressure switches for measuring vacuum available through each pump, a vacuum relief valve, a vacuum system air filter, vacuum operated instruments, a suction gauge, low vacuum warning on the annunciator, and a manifold with check valves to allow for normal vacuum system operation if one of the vacuum pumps should fail.

ATTITUDE INDICATOR

The attitude indicator is a vacuum air-driven gyro that gives a visual indication of flight attitude. Bank attitude is presented by a pointer at the top of the indicator relative to the bank scale which has index marks at 10°, 20°, 30°, 60°, and 90° either side of the center mark. Pitch and roll attitudes are presented by a miniature airplane superimposed over a symbolic horizon area divided into two sections by a white horizon bar. The upper "blue sky" area and the lower "ground" area have pitch reference lines useful for pitch attitude control. A knob at the bottom of the instrument is provided for in-flight adjustment of the symbolic airplane to the horizon bar for a more accurate flight attitude indication.

DIRECTIONAL INDICATOR

The directional indicator is a vacuum air-driven gyro that displays airplane heading on a compass card in relation to a fixed simulated airplane image and index. The indicator will precess slightly over a period of time. Therefore, the compass card should be set with the magnetic compass just prior to takeoff, and readjusted as required throughout the flight. A knob on the lower left edge of the instrument is used to adjust the compass card to correct for precession. A knob on the lower right edge of the instrument is used to move the heading bug.

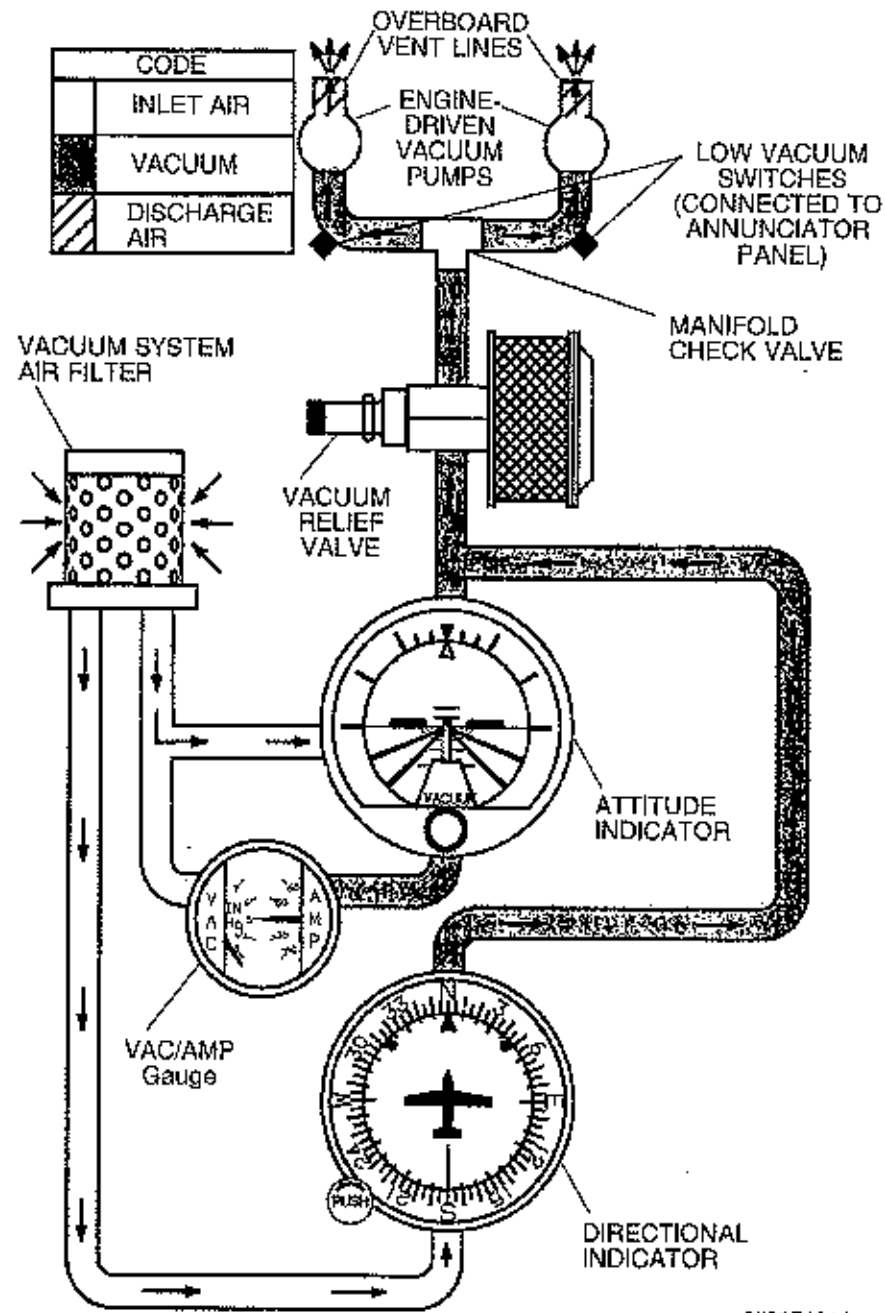

Figure 7-9. Vacuum System

VACUUM GAGE

The vacuum gage is part of the ammeter/vacuum gage, located on the lower left corner of the instrument panel. It is calibrated in inches of mercury and indicates vacuum air available for operation of the attitude and directional indicators. The desired vacuum range is 4.5 to 5.5 inches of mercury. Normally, a vacuum reading out of this range may indicate a system malfunction or improper adjustment, and in this case, the attitude and directional (heading) indicators should not be considered reliable. However, due to lower atmospheric pressures at higher altitudes, the vacuum gage may indicate as low as 4.0 in. Hg. at 20,000 feet and still be adequate for normal system operation.

LOW VACUUM ANNUNCIATION

Each engine-driven vacuum pump is plumbed to a common manifold, located forward of the firewall. From the tee, a single line runs into the cabin to operate the various vacuum system instruments. This tee contains check valves to prevent back flow into a pump if it fails. Transducers are located just upstream of the tee and measure vacuum output of each pump.

If output of the left pump falls below 3.0 in. Hg., the amber L VAC message will flash on the annunciator panel for approximately 10 seconds before turning steady on. If output of the right pump falls below 3.0 in. Hg., the amber VAC R message will flash on the annunciator panel for approximately 10 seconds before turning steady on. If output of both pumps falls below 3.0 in. Hg., the amber L VAC R message will flash on the annunciator panel for approximately 10 seconds before turning steady on.

CLOCK / O.A.T. INDICATOR

An integrated clock / O.A.T. / voltmeter is installed in the upper left side of the instrument panel as standard equipment. For a complete description and operating instructions, refer to the Supplements, Section 9.

STALL WARNING SYSTEM

The airplane is equipped with a pneumatic type stall warning system consisting of an inlet in the leading edge of the left wing, an air-operated horn near the upper left corner of the windshield, and associated plumbing. As the airplane approaches a stall, the low pressure on the upper surface of the wings moves forward around the leading edge of the wings. This low pressure creates a differential pressure in the stall warning system which draws air through the warning horn, resulting in an audible warning at 5 to 10 knots above stall in all flight conditions.

STANDARD AVIONICS

Standard avionics for the Model 172R airplanes include the following equipment:

| | |
|---------|---|
| KX-155A | Nav/Com Radio with KI 208 or KI 209A Indicator Head |
| KT-76C | Transponder |
| KMA-26 | Audio Panel |
| 3000-11 | Emergency Locator Transmitter (ELT) |

For complete operating instructions on the standard and optional avionics systems, refer to the Supplements, Section 9.

AVIONICS SUPPORT EQUIPMENT

Avionics operations are supported by the avionics cooling fan, microphone and headset installations and static discharge wicks.

AVIONICS COOLING FAN

An avionics cooling fan is installed on the left side of the interior firewall. The system utilizes a single electric fan and associated ductwork to force-cool the center stack radios.

Power to the electric fan is supplied through the AVN FAN circuit breaker. The fan operates whenever the Master and Avionics Master switches are both ON.

MICROPHONE AND HEADSET INSTALLATIONS

Standard equipment for the airplane includes a handheld microphone, an overhead speaker, two remote-keyed microphone switches on the control wheels, and provisions for boom mic/headsets at each pilot and passenger station.

The hand-held microphone contains an integral push-to-talk switch. This microphone is plugged into the center pedestal and is accessible to both the pilot and front passenger. Depressing the push-to-talk switch allows audio transmission on the Com radios.

The overhead speaker is located in the center overhead console. Volume and output for this speaker is controlled through the audio panel.

Each control wheel contains a miniature push-to-talk switch. This switch allows the pilot or front passenger to transmit on the Com radios using remote mics.

Each station of the airplane is wired for aviation-style headsets. Mic and headphone jacks are located on each respective arm rest and allow for communications between passengers and pilot. The system is wired so that microphones are all voice-activated. Additional wiring provisions inside the audio panel ensure that only the pilot or front passenger can transmit through the com radios.

NOTE

To ensure audibility and clarity when transmitting with the handheld microphone, always hold it as closely as possible to the lips, then key the microphone and speak directly into it. Avoid covering opening on back side of microphone for optimum noise canceling.

STATIC DISCHARGERS

Static wicks (static dischargers) are installed at various points throughout the airframe to reduce interference from precipitation static. Under some severe static conditions, loss of radio signals is possible even with static dischargers installed. Whenever possible, avoid known severe precipitation areas to prevent loss of dependable radio signals. If avoidance is impractical, minimize airspeed and anticipate temporary loss of radio signals while in these areas.

Static dischargers lose their effectiveness with age, and therefore, should be checked periodically (at least at every annual inspection) by qualified avionics technicians, etc.

CABIN FEATURES

EMERGENCY LOCATOR TRANSMITTER (ELT)

A remote switch/annunciator is installed on the top center location of the copilot's instrument panel for control of the ELT from the flight crew station. The annunciator, which is in the center of the rocker switch, illuminates when the ELT transmitter is transmitting. The ELT emits an omni-directional signal on the international distress frequencies of 121.5 MHz and 243.0 MHz. General aviation and commercial aircraft, the FAA and CAP monitor 121.5 MHz, and 243.0 MHz is monitored by the military. For a basic overview of the ELT, refer to the Supplements, Section 9.

CABIN FIRE EXTINGUISHER

A portable Halon 1211 (Bromochlorodifluoromethane) fire extinguisher is standard and is installed on the floorboard near the pilot's seat where it would be accessible in case of fire. The extinguisher has an Underwriters Laboratories classification of 5B:C. If installed, the extinguisher should be checked prior to each flight to ensure that its bottle pressure, as indicated by the gauge on the bottle, is within the green arc (approximately 125 psi) and the operating lever lock pin is securely in place.

To operate the fire extinguisher:

1. Loosen retaining clamp(s) and remove extinguisher from bracket.
2. Hold extinguisher upright, pull operating ring pin, and press lever while directing the discharge at the base of the fire at the near edge. Progress toward the back of the fire by moving the nozzle rapidly with a side to side sweeping motion.

 **WARNING**

VENTILATE THE CABIN PROMPTLY AFTER SUCCESSFULLY EXTINGUISHING THE FIRE TO REDUCE THE GASES PRODUCED BY THERMAL DECOMPOSITION.

3. Anticipate approximately eight seconds of discharge duration.

Fire extinguishers should be recharged by a qualified fire extinguisher agency after each use. Such agencies are listed under "Fire Extinguisher" in the telephone directory. After recharging, secure the extinguisher to its mounting bracket; do not allow it to lie loose on shelves or seats.

MINIATURE

MAINTENANCE

SECTION 8 AIRPLANE HANDLING, SERVICE & MAINTENANCE

| TABLE OF CONTENTS | Page |
|---|------|
| Introduction | 8-3 |
| Identification Plate | 8-4 |
| Cessna Owner Advisories | 8-4 |
| United States Airplane Owners | 8-5 |
| International Airplane Owners | 8-5 |
| Publications | 8-5 |
| Airplane File | 8-6 |
| Airplane Inspection Periods | 8-7 |
| FAA Required Inspections | 8-7 |
| Cessna Inspection Programs | 8-8 |
| Cessna Customer Care Program | 8-8 |
| Pilot Conducted Preventive Maintenance | 8-9 |
| Alterations Or Repairs | 8-9 |
| Ground Handling | 8-10 |
| Towing | 8-10 |
| Parking | 8-10 |
| Tie-Down | 8-11 |
| Jacking | 8-11 |
| Leveling | 8-12 |
| Flyable Storage | 8-12 |
| Servicing | 8-13 |
| Oil | 8-14 |
| Oil Specification | 8-14 |
| Recommended Viscosity for Temperature Range | 8-14 |

TABLE OF CONTENTS (Continued)

| | Page |
|---|------|
| Capacity of Engine Sump | 8-15 |
| Oil and Oil Filter Change | 8-15 |
| Fuel | 8-16 |
| Approved Fuel Grades (and Colors) | 8-16 |
| Fuel Capacity | 8-16 |
| Fuel Additives | 8-16 |
| Fuel Contamination | 8-20 |
| Landing Gear | 8-21 |
| Cleaning And Care | 8-21 |
| Windshield And Windows | 8-21 |
| Painted Surfaces | 8-22 |
| Propeller Care | 8-23 |
| Engine Care | 8-23 |
| Interior Care | 8-24 |

INTRODUCTION

This section contains factory recommended procedures for proper ground handling and routine care and servicing of your airplane. It also identifies certain inspection and maintenance requirements which must be followed if your airplane is to retain that new airplane performance and dependability. It is important to follow a planned schedule of lubrication and preventive maintenance based on climatic and flying conditions encountered in your local area.

Keep in touch with your local Cessna Service Station and take advantage of their knowledge and experience. Your Cessna Service Station knows your airplane and how to maintain it, and will remind you when lubrications and oil changes are necessary, as well as other seasonal and periodic services.

The airplane should be regularly inspected and maintained in accordance with information found in the airplane maintenance manual and in company issued service bulletins and service newsletters. All service bulletins pertaining to the aircraft by serial number should be accomplished and the airplane should receive repetitive and required inspections. Cessna does not condone modifications, whether by Supplemental Type Certificate or otherwise, unless these certificates are held and/or approved by Cessna. Other modifications may void warranties on the airplane since Cessna has no way of knowing the full effect on the overall airplane. Operation of an airplane that has been modified may be a risk to the occupants, and operating procedures and performance data set forth in the operating handbook may no longer be considered accurate for the modified airplane.

IDENTIFICATION PLATE

All correspondence regarding your airplane should include the Serial Number. The Serial Number, Model Number, Production Certificate Number (PC) and Type Certificate Number (TC) can be found on the Identification Plate, located on the aft left tailcone. A secondary Identification Plate is installed on the lower part of the left forward doorpost on earlier serial number airplanes. The Finish and Trim Plate, located on the lower part of the left forward doorpost, contains a code describing the exterior paint configuration for the airplane. The code may be used in conjunction with an applicable Illustrated Parts Catalog if finish and trim information is needed.

CESSNA OWNER ADVISORIES

Cessna Owner Advisories are sent to Cessna Aircraft FAA Registered owners of record at no charge to inform them about mandatory and/or beneficial aircraft service requirements and product changes. Copies of the actual bulletins are available from Cessna Service Stations and Cessna Customer Service.

UNITED STATES AIRPLANE OWNERS

If your airplane is registered in the U. S., appropriate Cessna Owner Advisories will be mailed to you automatically according to the latest aircraft registration name and address which you have provided to the FAA. Therefore, it is important that you provide correct and up-to-date mailing information to the FAA.

If you require a duplicate Owner Advisory to be sent to an address different from the FAA aircraft registration address, please complete and return an Owner Advisory Application (otherwise no action is required on your part).

INTERNATIONAL AIRPLANE OWNERS

To receive Cessna Owner Advisories, please complete and return an Owner Advisory Application.

Receipt of a valid Owner Advisory Application will establish your Cessna Owner Advisory service for one year, after which you will be sent a renewal notice. It is important that you respond promptly to update your address for this critical service.

PUBLICATIONS

Various publications and flight operation aids are furnished in the airplane when delivered from the factory. These items are listed below.

- Customer Care Program Handbook
- Pilot's Operating Handbook and FAA Approved Airplane Flight Manual
- Pilot's Checklist
- Passenger Briefing Card
- Cessna Sales and Service Directory

To obtain additional publications or Owner Advisory information, you may contact Cessna's Product Support Department at (316) 517-5800. Fax (316) 942-9006 or write to The Cessna Aircraft Company, P.O. Box 7706, Wichita, KS 67277, Dept 751C.

The following additional publications, plus many other supplies that are applicable to your airplane, are available from your local Cessna Service Station.

- Information Manual (contains Pilot's Operating Handbook Information)
- Maintenance Manual, Wiring Diagram Manual and Illustrated Parts Catalog

Your local Cessna Service Station has a Customer Care Supplies and Publications Catalog covering all available items, many of which the Service Station keeps on hand. The Service Station can place an order for any item which is not in stock.

NOTE

A Pilot's Operating Handbook and FAA Approved Airplane Flight Manual which is lost or destroyed may be replaced by contacting your local Cessna Service Station. An affidavit containing the owner's name, airplane serial number and reason for replacement must be included in replacement requests since the Pilot's Operating Handbook and FAA Approved Airplane Flight Manual is identified for specific serial numbered airplanes only.

AIRPLANE FILE

There are miscellaneous data, information and licenses that are a part of the airplane file. The following is a checklist for that file. In addition, a periodic check should be made of the latest Federal Aviation Regulations to ensure that all data requirements are met.

To be displayed in the airplane at all times:

1. Aircraft Airworthiness Certificate (FAA Form 8100-2).
2. Aircraft Registration Certificate (FAA Form 8050-3).
3. Aircraft Radio Station License, (if applicable).

To be carried in the airplane at all times:

1. Current Pilot's Operating Handbook and FAA Approved Airplane Flight Manual.
2. Weight and Balance, and associated papers (latest copy of the Repair and Alteration Form, FAA Form 337, if applicable).
3. Equipment List.

To be made available upon request:

1. Airplane Logbook.
2. Engine Logbook.

Most of the items listed are required by the United States Federal Aviation Regulations. Since the Regulations of other nations may require other documents and data, owners of airplanes not registered in the United States should check with their own aviation officials to determine their individual requirements.

Cessna recommends that these items, plus the Pilot's Checklists, Customer Care Program Handbook and Customer Care Card, be carried in the airplane at all times.

AIRPLANE INSPECTION PERIODS

FAA REQUIRED INSPECTIONS

As required by U.S. Federal Aviation Regulations, all civil aircraft of U.S. registry must undergo a complete inspection (annual) each twelve calendar months. In addition to the required annual inspection, aircraft operated commercially (for hire) must have a complete inspection every 100 hours of operation.

The FAA may require other inspections by the issuance of airworthiness directives applicable to the airplane, engine, propeller and components. It is the responsibility of the owner/operator to ensure compliance with all applicable airworthiness directives, and when the inspections are repetitive, to take appropriate steps to prevent inadvertent noncompliance.

CESSNA INSPECTION PROGRAMS

In lieu of the 100 hour and annual inspection requirements, an airplane may be inspected in accordance with a Progressive Care Inspection Program or a Phase Card Inspection Program. Both programs offer systems which allow the work load to be divided into smaller operations that can be accomplished in shorter time periods.

The Cessna Progressive Care Inspection Program allows an airplane to be inspected and maintained in four operations. The four operations are recycled each 200 hours and are recorded in a specially provided Aircraft Inspection Log as each operation is conducted.

The Phase Card Inspection Program offers a parallel system for high-utilization flight operations (approximately 600 flight hours per year). This system utilizes 50 hour intervals (Phase 1 and Phase 2) to inspect high-usage systems and components. At 12 months or 600 flight hours, whichever occurs first, the airplane undergoes a complete (Phase 3) inspection.

Regardless of the inspection method selected, the owner should keep in mind that FAR Part 43 and FAR Part 91 establishes the requirement that properly certified agencies or personnel accomplish all required FAA inspections and most of the manufacturer recommended inspections.

CESSNA CUSTOMER CARE PROGRAM

Specific benefits and provisions of the Cessna Warranty plus other important benefits for you are contained in your Customer Care Program Handbook supplied with your airplane. The Customer Care Program Handbook should be thoroughly reviewed and kept in the airplane at all times.

You will also want to return to your Cessna Service Station either at 50 hours for your first Progressive Care Operation, or at 100 hours for your first 100 hour inspection depending on which program you choose to establish for your airplane. While these important inspections will be performed for you by any Cessna Service Station, in most cases you will prefer to have the Cessna Service Station from whom you purchased the airplane accomplish this work.

PILOT CONDUCTED PREVENTIVE MAINTENANCE

A certified pilot who owns or operates an airplane not used as an air carrier is authorized by FAR Part 43 to perform limited maintenance on his airplane. Refer to FAR Part 43 for a list of the specific maintenance operations which are allowed.

NOTE

Pilots operating airplanes of other than U.S. registry should refer to the regulations of the country of certification for information on preventive maintenance that may be performed by pilots.

A Maintenance Manual must be obtained prior to performing any preventive maintenance to ensure that proper procedures are followed. Your local Cessna Service Station should be contacted for further information or for required maintenance which must be accomplished by appropriately licensed personnel.

ALTERATIONS OR REPAIRS

It is essential that the FAA be contacted prior to any alterations on the airplane to ensure that airworthiness of the airplane is not violated. Alterations or repairs to the airplane must be accomplished by licensed personnel, utilizing only FAA Approved components and FAA Approved data, such as Cessna Service Bulletins.

GROUND HANDLING

TOWING

The airplane is most easily and safely maneuvered by hand with the tow bar attached to the nose wheel (the tow bar is stowed on the side of the baggage area). When towing with a vehicle, do not exceed the nose gear turning angle of 30° either side of center, or damage to the nose landing gear will result.

CAUTION

REMOVE ANY INSTALLED RUDDER LOCK BEFORE TOWING.

If the airplane is towed or pushed over a rough surface during hangaring, watch that the normal cushioning action of the nose strut does not cause excessive vertical movement of the tail and the resulting contact with low hangar doors or structure. A flat nose tire or deflated strut will also increase tail height.

PARKING

When parking the airplane, head into the wind and set the parking brakes. Do not set the parking brakes during cold weather when accumulated moisture may freeze the brakes, or when the brakes are overheated. Install the control wheel lock and chock the wheels. In severe weather and high wind conditions, tie the airplane down as outlined in the following paragraph.

TIE-DOWN

Proper tie-down procedure is the best precaution against damage to the parked airplane by gusty or strong winds. To tie-down the airplane securely, proceed as follows:

1. Set the parking brake and install the control wheel lock.
2. Install a surface control lock over the fin and rudder.
3. Tie sufficiently strong ropes or chains (700 pounds tensile strength) to the wing, tail and nose tie-down fittings and secure each rope or chain to a ramp tie-down.
4. Install a pitot tube cover.

JACKING

When a requirement exists to jack the entire airplane off the ground, or when wing jack points are used in the jacking operation, refer to the Maintenance Manual for specific procedures and equipment required.

Individual main gear may be jacked by using the jack pad which is incorporated in the main landing gear strut step bracket. When using the individual gear strut jack pad, flexibility of the gear strut will cause the main wheel to slide inboard as the wheel is raised, tilting the jack. The jack must then be lowered for a second jacking operation. Do not jack both main wheels simultaneously using the individual main gear jack pads.

CAUTION

**DO NOT APPLY PRESSURE ON THE ELEVATOR
OR HORIZONTAL STABILIZER SURFACES.
WHEN PUSHING ON THE TAILCONE, ALWAYS
APPLY PRESSURE AT A BULKHEAD TO AVOID
BUCKLING THE SKIN.**

If nose gear maintenance is required, the nose wheel may be raised off the ground by pressing down on a tailcone bulkhead, just forward of the horizontal stabilizer, and allowing the tail to rest on the tail tie-down ring.

To assist in raising and holding the nose wheel off the ground, ground anchors should be utilized at the tail tie down point.

NOTE

Ensure that the nose will be held off the ground under all conditions by means of suitable stands or supports under weight supporting bulkheads near the nose of the airplane.

LEVELING

Longitudinal leveling of the airplane is accomplished by placing a level on leveling screws located on the left side of the tailcone. Deflate the nose tire and/or lower or raise the nose strut to properly center the bubble in the level. Corresponding points on both upper door sills may be used to level the airplane laterally.

FLYABLE STORAGE

Airplanes placed in non operational storage for a maximum of 30 days or those which receive only intermittent operational use for the first 25 hours are considered in flyable storage status. Every seventh day during these periods, the propeller should be rotated by hand through five revolutions. This action "limbers" the oil and helps prevent any accumulation of corrosion on engine cylinder walls.

⚠ WARNING

FOR MAXIMUM SAFETY, CHECK THAT THE IGNITION SWITCH IS OFF, THE THROTTLE IS CLOSED, THE MIXTURE CONTROL IS IN THE IDLE CUT OFF POSITION, AND THE AIRPLANE IS SECURED BEFORE ROTATING THE PROPELLER BY HAND. DO NOT STAND WITHIN THE ARC OF THE PROPELLER BLADES WHILE TURNING THE PROPELLER.

After 30 days, the airplane should be flown for 30 minutes or a ground runup should be made just long enough to produce an oil temperature within the lower green arc range. Excessive ground runup should be avoided.

Engine runup also helps to eliminate excessive accumulations of water in the fuel system and other air spaces in the engine. Keep fuel tanks full to minimize condensation in the tanks. Keep the battery fully charged to prevent the electrolyte from freezing in cold weather. If the airplane is to be stored temporarily, or indefinitely, refer to the Maintenance Manual for proper storage procedures.

SERVICING

In addition to the Preflight Inspection covered in Section 4 of this handbook, complete servicing, inspection and test requirements for your airplane are detailed in the Maintenance Manual. The Maintenance Manual outlines all items which require attention at specific intervals plus those items which require servicing, inspection, and/or testing at special intervals.

Since Cessna Service Stations conduct all service, inspection, and test procedures in accordance with applicable Maintenance Manuals, it is recommended that you contact your local Cessna Service Station concerning these requirements and begin scheduling your airplane for service at the recommended intervals.

Cessna Progressive Care ensures that these requirements are accomplished at the required intervals to comply with the 100 hour or annual inspection as previously covered.

Depending on various flight operations, your local Government Aviation Agency may require additional service, inspections, or tests. For these regulatory requirements, owners should check with local aviation officials where the airplane is being operated.

For quick and ready reference, quantities, materials and specifications for frequently used service items are as follows.

OIL

OIL SPECIFICATION

■ MIL-L-6082 or SAE J1966 Aviation Grade Straight Mineral Oil: Used when the airplane was delivered from the factory and should be used to replenish the supply during the first 25 hours. This oil should be drained and filter replaced after the first 25 hours of operation. Refill the engine and continue to use until a total of 50 hours has accumulated or oil consumption has stabilized.

■ MIL-L-22851 or SAE J1899 Aviation Grade Ashless Dispersant Oil: Oil conforming to Textron Lycoming Service Instruction No. 1014, and all revision and supplements thereto, must be used after first 50 hours, or when oil consumption has stabilized.

RECOMMENDED VISCOSITY FOR TEMPERATURE RANGE

Multiviscosity or straight grade oil may be used throughout the year for engine lubrication. Refer to the following table for temperature versus viscosity ranges.

| Temperature | MIL-L-6082 or SAE J1966 Straight Mineral Oil SAE Grade | MIL-L-22851 or SAE J1899 Ashless Dispersant SAE Grade |
|----------------------------|---|--|
| Above 27°C (80°F) | 60 | 60 |
| Above 16°C (60°F) | 50 | 40 or 50 |
| -1°C (30°F) to 32°C (90°F) | 40 | 40 |
| -18°C (0°F) to 21°C (70°F) | 30 | 30, 40 or 20W-40 |
| Below -12°C (10°F) | 20 | 30 or 20W-30 |
| -18°C (0°F) to 32°C (90°F) | 20W-50 | 20W-50 or 15W-50 |
| All Temperatures | --- | 15W-50, 20W-50 |

CAPACITY OF ENGINE SUMP

The engine lubrication system has a total capacity of 9 quarts of oil, with the oil filter accounting for 1 quart of that total. The engine oil sump (crankcase) has a capacity of 8 quarts. The engine must not be operated with less than 5 quarts in the sump. For extended flights, the engine oil level should be at 8 quarts.

OIL AND OIL FILTER CHANGE

After the first 25 hours of operation, drain the engine oil sump and replace the filter. Refill sump with straight mineral oil and use until a total of 50 hours has accumulated or oil consumption has stabilized; then change to ashless dispersant oil. Ashless dispersant oil (and oil filter) should then be changed at time intervals set forth by the engine manufacturer.

NOTE

During the first 25 hour oil and filter change, a general inspection of the overall engine compartment is required. Items which are not normally checked during a preflight inspection should be given special attention. Hoses, metal lines and fittings should be inspected for signs of oil and fuel leaks, and checked for abrasions, chafing, security, proper routing and support, and evidence of deterioration. Inspect the intake and exhaust systems for cracks, evidence of leakage, and security of attachment. Engine controls and linkages should be checked for freedom of movement through their full range, security of attachment and evidence of wear. Inspect wiring for security, chafing, burning, defective insulation, loose or broken terminals, heat deterioration, and corroded terminals. Check the alternator belt in accordance with Maintenance Manual instructions, and retighten if necessary. A periodic check of these items during subsequent servicing operations is recommended.

FUEL

APPROVED FUEL GRADES (AND COLORS)

100LL Grade Aviation Fuel (Blue).
100 Grade Aviation Fuel (Green).

NOTE

Isopropyl alcohol or diethylene glycol monomethyl ether (DiEGME) may be added to the fuel supply in quantities not to exceed 1% (alcohol) or 0.15% (DiEGME) of total volume. Refer to Fuel Additives in later paragraphs for additional information.

FUEL CAPACITY

■ 56.0 U.S. Gallons Total: 28.0 U.S. Gallons per tank.

NOTE

To ensure maximum fuel capacity when refueling and minimize cross feeding, the fuel selector valve should be placed in either the LEFT or RIGHT position and the airplane parked in a wings level, normal ground attitude. Refer to Figure 1-1 for a definition of normal ground attitude.

Service the fuel system after each flight, and keep fuel tanks full to minimize condensation in the tanks.

FUEL ADDITIVES

Strict adherence to recommended preflight draining instructions as called for in Section 4 will eliminate any free water accumulations from the tank sumps. While small amounts of water may still remain in solution in the gasoline, it will normally be consumed and go unnoticed in the operation of the engine.

One exception to this can be encountered when operating under the combined effect of: (1) use of certain fuels, with (2) high humidity conditions on the ground (3) followed by flight at high altitude and low temperature. Under these unusual conditions, small amounts of water in solution can precipitate from the fuel stream and freeze in sufficient quantities to induce partial icing of the engine fuel system.

While these conditions are quite rare and will not normally pose a problem to owners and operators, they do exist in certain areas of the world and consequently must be dealt with, when encountered.

Therefore, to help alleviate the possibility of fuel icing occurring under these unusual conditions, it is permissible to add isopropyl alcohol or diethylene glycol monomethyl ether (DiEGME) compound to the fuel supply.

The introduction of alcohol or DiEGME compound into the fuel provides two distinct effects: (1) it absorbs the dissolved water from the gasoline and (2) alcohol has a freezing temperature depressant effect.

NOTE

When using fuel additives, it must be remembered that the final goal is to obtain a correct fuel-to-additive ratio in the tank, and not just with fuel coming out of the refueling nozzle. For example, adding 15 gallons of correctly proportioned fuel to a tank which contains 20 gallons of untreated fuel will result in a lower-than-acceptable concentration level to the 35 gallons of fuel which now reside in the tank.

Alcohol, if used, is to be blended with the fuel in a concentration of 1% by volume. Concentrations greater than 1% are not recommended since they can be detrimental to fuel tank materials.

The manner in which the alcohol is added to the fuel is significant because alcohol is most effective when it is completely dissolved in the fuel. To ensure proper mixing, the following is recommended:

1. For best results, the alcohol should be added during the fueling operation by pouring the alcohol directly on the fuel stream issuing from the fueling nozzle.

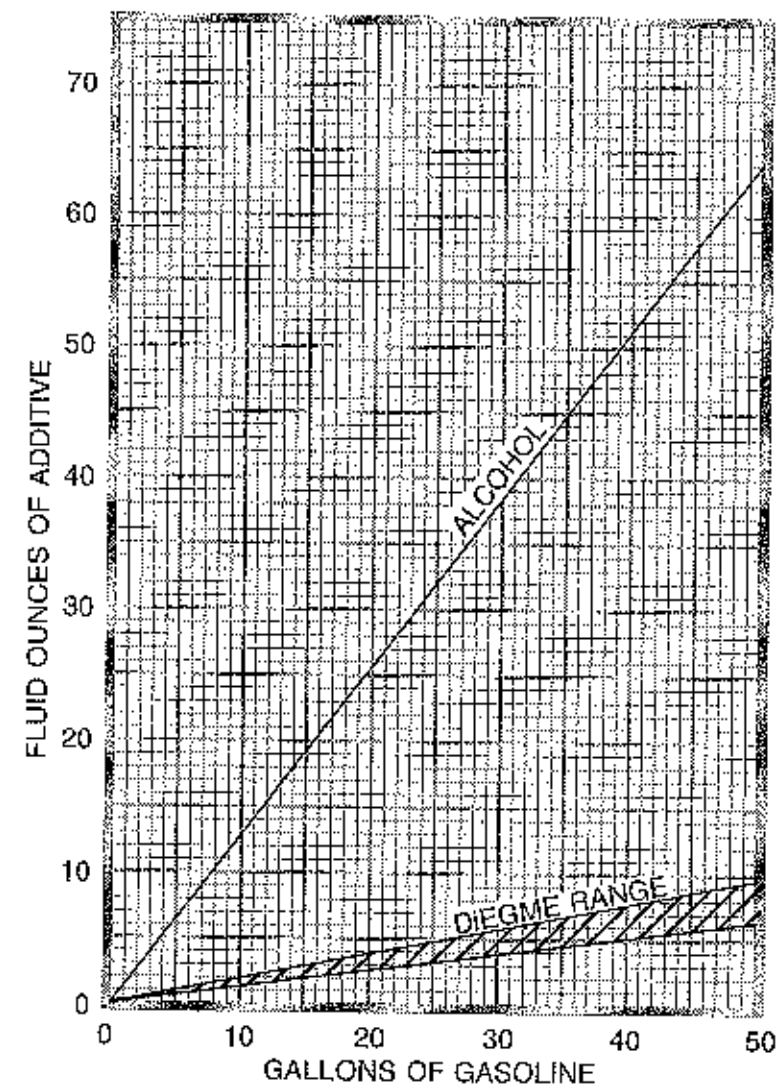

0585C1001

Figure 8-1. Fuel Mixing Ratio

2. An alternate method that may be used is to premix the complete alcohol dosage with some fuel in a separate clean container (approximately 2-3 gallon capacity) and then transferring this mixture to the tank prior to the fuel operation.

Diethylene glycol monomethyl ether (DiEGME) compound must be carefully mixed with the fuel in concentrations between 0.10% (minimum) and 0.15% (maximum) of total fuel volume. Refer to Figure 8-1 for a DiEGME-to-fuel mixing chart.

⚠ CAUTION

ANTHICING ADDITIVE IS DANGEROUS TO HEALTH WHEN BREATHED AND/OR ABSORBED INTO THE SKIN.

⚠ CAUTION

MIXING OF DIEGME WITH FUEL IS EXTREMELY IMPORTANT. A CONCENTRATION IN EXCESS OF THAT RECOMMENDED (0.15% BY VOLUME MAXIMUM) MAY RESULT IN DETRIMENTAL EFFECTS TO THE FUEL TANK SEALANT, AND DAMAGE TO O-RINGS AND SEALS USED IN THE FUEL SYSTEM AND ENGINE COMPONENTS. A CONCENTRATION OF LESS THAN THAT RECOMMENDED (0.10% BY TOTAL VOLUME MINIMUM) WILL RESULT IN INEFFECTIVE TREATMENT. USE ONLY BLENDING EQUIPMENT THAT IS RECOMMENDED BY THE MANUFACTURER TO OBTAIN PROPER PROPORTIONING.

Prolonged storage of the airplane will result in a water buildup in the fuel which "leeches out" the additive. An indication of this is when an excessive amount of water accumulates in the fuel tank sumps. The concentration can be checked using a differential refractometer. It is imperative that the technical manual for the differential refractometer be followed explicitly when checking the additive concentration.

FUEL CONTAMINATION

Fuel contamination is usually the result of foreign material present in the fuel system, and may consist of water, rust, sand, dirt, microbes or bacterial growth. In addition, additives that are not compatible with fuel or fuel system components can cause the fuel to become contaminated.

Before each flight and after each refueling, use a clear sampler cup and drain at least a cupful of fuel from each fuel tank drain location and from the fuel strainer quick drain valve to determine if contaminants are present, and to ensure the airplane has been fueled with the proper grade of fuel.

If contamination is detected, drain **all** fuel drain points again, including the fuel reservoir and fuel selector quick drain valves and then gently rock the wings and lower the tail to the ground to move any additional contaminants to the sampling points. Take repeated samples from all fuel drain points until **all** contamination has been removed. If, after repeated sampling, evidence of contamination still exists, the airplane should not be flown. Tanks should be drained and system purged by qualified maintenance personnel. All evidence of contamination must be removed before further flight. If the airplane has been serviced with the improper fuel grade, defuel completely and refuel with the correct grade. Do not fly the airplane with contaminated or unapproved fuel.

In addition, Owners/Operators who are not acquainted with a particular fixed base operator should be assured that the fuel supply has been checked for contamination and is properly filtered before allowing the airplane to be serviced. Fuel tanks should be kept full between flights, provided weight and balance considerations will permit, to reduce the possibility of water condensing on the walls of partially filled tanks.

To further reduce the possibility of contaminated fuel, routine maintenance of the fuel system should be performed in accordance with the airplane Maintenance Manual. Only the proper fuel, as recommended in this handbook, should be used, and fuel additives should not be used unless approved by Cessna and the Federal Aviation Administration.

LANDING GEAR

Consult the following table for servicing information on the landing gear.

| COMPONENT | SERVICING CRITERIA |
|---------------------------------------|------------------------|
| Nose Wheel (5.00-5, 6-Ply Rated Tire) | 34.0 PSI |
| Main Wheel (6.00-6, 4-Ply Rated Tire) | 28.0 PSI |
| Brakes | MIL-H-5606 |
| Nose Gear Shock Strut | MIL-H-5606; 45.0 PSI * |

* Keep strut filled with MIL-H-5606 hydraulic fluid per filling instructions placard, and with no load on the strut, inflate with air to 45.0 PSI. Do not over inflate.

CLEANING AND CARE

WINDSHIELD AND WINDOWS

The plastic windshield and windows should be cleaned with an aircraft windshield cleaner. Apply the cleaner sparingly with soft cloths, and rub with moderate pressure until all dirt, oil scum and bug stains are removed. Allow the cleaner to dry, then wipe it off with soft flannel cloths.

CAUTION

NEVER USE GASOLINE, BENZENE, ALCOHOL, ACETONE, FIRE EXTINGUISHER, ANTI-ICE FLUID, LACQUER THINNER OR GLASS CLEANER TO CLEAN THE PLASTIC. THESE MATERIALS WILL ATTACK THE PLASTIC AND MAY CAUSE IT TO CRAZE.

If a windshield cleaner is not available, the plastic can be cleaned with soft cloths moistened with Stoddard solvent to remove oil and grease.

Follow by carefully washing with a mild detergent and plenty of water. Rinse thoroughly, then dry with a clean moist chamois. Do not rub the plastic with a dry cloth since this builds up an electrostatic charge which attracts dust. Waxing with a good commercial wax will finish the cleaning job. A thin, even coat of wax, polished out by hand with clean soft flannel cloths, will fill in minor scratches and help prevent further scratching.

Do not use a canvas cover on the windshield unless freezing rain or sleet is anticipated since the cover may scratch the plastic surface.

PAINTED SURFACES

The painted exterior surfaces of your new Cessna have a durable, long lasting finish.

Generally, the painted surfaces can be kept bright by washing with water and mild soap, followed by a rinse with water and drying with cloths or a chamois. Harsh or abrasive soaps or detergents which cause corrosion or scratches should never be used. Remove stubborn oil and grease with a cloth moistened with Stoddard solvent. Take special care to make sure that the exterior graphics are not touched by the solvent. For complete care of exterior graphics refer to the Maintenance Manual.

To seal any minor surface chips or scratches and protect against corrosion, the airplane should be waxed regularly with a good automotive wax applied in accordance with the manufacturer's instructions. If the airplane is operated in a seacoast or other salt water environment, it must be washed and waxed more frequently to assure adequate protection. Special care should be taken to seal around rivet heads and skin laps, which are the areas most susceptible to corrosion. A heavier coating of wax on the leading edges of the wings and tail and on the cowl nose cap and propeller spinner will help reduce the abrasion encountered in these areas. Reapplication of wax will generally be necessary after cleaning with soap solution or after chemical deicing operations.

When the airplane is parked outside in cold climates and it is necessary to remove ice before flight, care should be taken to protect the painted surfaces during ice removal with chemical liquids. Isopropyl alcohol will satisfactorily remove ice accumulations without damaging the paint. However, keep the isopropyl alcohol away from the windshield and cabin windows since it will attack the plastic and may cause it to craze.

PROPELLER CARE

Preflight inspection of propeller blades for nicks, and wiping them occasionally with an oily cloth to clean off grass and bug stains will assure long blade life. Small nicks on the propeller, particularly near the tips and on the leading edges, should be dressed out as soon as possible since these nicks produce stress concentrations, and if ignored, may result in cracks or failure of the propeller blade. Never use an alkaline cleaner on the blades; remove grease and dirt with Stoddard solvent.

ENGINE CARE

The engine may be cleaned, using a suitable solvent, in accordance with instructions in the airplane Maintenance Manual. Most efficient cleaning is done using a spray type cleaner. Before spray cleaning, ensure that protection is afforded for components which might be adversely affected by the solvent. Refer to the Maintenance Manual for proper lubrication of controls and components after engine cleaning. The induction air filter should be replaced when its condition warrants, not to exceed 500 hours.

INTERIOR CARE

To remove dust and loose dirt from the upholstery and carpet, clean the interior regularly with a vacuum cleaner.

Blot up any spilled liquid promptly with cleansing tissue or rags. Don't pat the spot; press the blotting material firmly and hold it for several seconds. Continue blotting until no more liquid is taken up. Scrape off sticky materials with a dull knife, then spot clean the area.

Oily spots may be cleaned with household spot removers, used sparingly. Before using any solvent, read the instructions on the container and test it on an obscure place on the fabric to be cleaned. Never saturate the fabric with a volatile solvent; it may damage the padding and backing materials.

Soiled upholstery and carpet may be cleaned with foam type detergent, used according to the manufacturer's instructions. To minimize wetting the fabric, keep the foam as dry as possible and remove it with a vacuum cleaner.

For complete information related to interior cleaning, refer to the Maintenance Manual.

1. The first part of the document discusses the importance of maintaining accurate records of all transactions. It emphasizes that this is crucial for ensuring the integrity of the financial statements and for providing a clear audit trail. The text notes that any discrepancies or errors in the records can lead to significant complications during an audit and may result in the disallowance of certain expenses.

2. The second part of the document addresses the issue of proper documentation. It states that all receipts, invoices, and other supporting documents must be retained for a minimum of three years. This requirement is intended to ensure that all necessary evidence is available to substantiate the reported amounts and to facilitate the audit process. The document also mentions that the retention period may be extended in certain circumstances, such as when there is a pending litigation or a tax dispute.

3. The third part of the document discusses the importance of timely reporting. It notes that all financial information should be reported to the appropriate authorities in a timely and accurate manner. This includes the filing of tax returns and the submission of financial statements. The text emphasizes that failure to report information accurately or on time can result in penalties and may also affect the company's reputation and ability to secure financing.

4. The fourth part of the document discusses the importance of transparency and communication. It states that all stakeholders, including shareholders, creditors, and regulatory authorities, should be kept informed of the company's financial performance and any significant developments. This includes providing regular updates on the company's financial position and any changes in its financial policies or procedures. The document also notes that transparency and communication are essential for building trust and confidence among stakeholders and for ensuring the long-term success of the company.

SUPPLEMENTS

INTRODUCTION

The supplements in this section contain expanded operational procedures for both standard and optional equipment installed in the airplane. Operators should refer to each supplement to ensure that all limitations and procedures appropriate for their airplane are observed.

A Log Of Approved Supplements is provided, for convenience only, beginning on page Log-1 and is a numerical list of all supplements applicable to this airplane by name, number and revision level. This log should be used as a checklist to ensure all applicable supplements have been placed in the Pilot's Operating Handbook (POH). Supplements may be removed from the POH provided the equipment is not installed on the airplane. If equipment is installed on the airplane, however, the supplement(s) must be retained and updated as revisions to each supplement are issued.

Each individual supplement contains its own Log of Effective Pages. This log lists the page number and effective date of every page in the supplement. The log also lists the dates on which revisions to the supplement occurred. Additionally, the part number of the supplement provides information on the revision level. Refer to the following example:

172R-S1-04

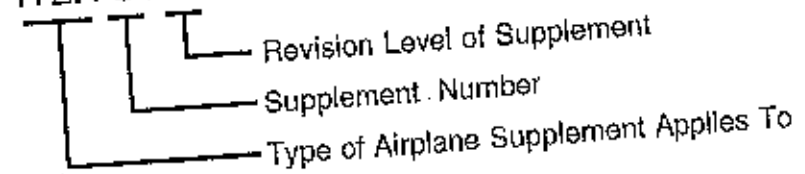

**SUPPLEMENT
REVISION**

MODEL 172R

PILOT'S OPERATING HANDBOOK
AND FAA APPROVED
AIRPLANE FLIGHT MANUAL

REVISION 4
31 OCTOBER 2002

PART NUMBER:
172RPHUS-S7-04

INSERT THE FOLLOWING PAGES INTO
THE SUPPLEMENT SECTION OF THE PILOT'S
OPERATING HANDBOOK

E
T

S

F
C
E
A
S
E

LOG OF APPROVED SUPPLEMENTS

| SUPP. NO. | SUPPLEMENT NAME | REVISION LEVEL | EQUIPMENT INSTALLED |
|-----------|---|----------------|---------------------|
| 11 | Reserved | | |
| 12 | Canadian Supplement | 1 | _____ |
| 13 | Bendix/King KCS-55A Slaved Compass System with KI-525A Horizontal Situation Indicator (HSI) | 1 | _____ |
| 14 | Argentine Supplement | 0 | _____ |
| 15 | Bendix/King KAP 140 2 Axis Autopilot | 3 | _____ |
| 16 | Reserved | | |
| 17 | Reserved | | |
| 18 | Reserved | | |
| 19 | Bendix/King KLN 94 Global Positioning System | 4 | _____ |
| 20 | Bendix/King KMA 28 Audio Selector Panel | 0 | _____ |
| 21 | Bendix/King KMD 550 Multi-Function Display | 0 | _____ |
| 22 | 12 Volt Cabin Power System | 0 | _____ |
| 24 | Astrotech Model TC-2 Clock/OAT/Volt Indicator | 0 | _____ |
| 25 | Bendix/King KX 165A VHF NAV/COM | 0 | _____ |
| 26 | Bendix/King KDR 510 Flight Information Services (FIS) | 0 | _____ |

Alamo Aerospace 180 hp STC X

Garmin GNX375 ADSB STC X



**Pilot's Operating Handbook and
FAA Approved Airplane Flight Manual**

**CESSNA MODEL 172R
AIRPLANES 80001 AND ON**

SUPPLEMENT 1

**BENDIX/KING KX 155A
VHF NAV/COMM
with KI 208 or KI 209A INDICATOR HEAD**

| |
|------------------------|
| SERIAL NO. _____ |
| REGISTRATION NO. _____ |

This supplement must be inserted into Section 9 of the Pilot's Operating Handbook and FAA Approved Airplane Flight Manual.

| |
|--|
| FAA APPROVAL FAA APPROVED UNDER FAR 21 SUBPART J The Cessna Aircraft Co Delegation Option Manufacturer CE-1 <i>Michael W. Nelsky</i> Executive Engineer Date: December 10, 1996 |
|--|

 Member of GAMA
2 December 1996

COPYRIGHT © 1996
CESSNA AIRCRAFT COMPANY
WICHITA, KANSAS, USA

172RPLUS-S1-00

S1-1

SUPPLEMENT 1

BENDIX/KING KX 155A VHF NAV/COMM with KI 208 or KI 209A INDICATOR HEAD

The following Log of Effective Pages provides the date of issue for original and revised pages, as well as a listing of all pages in the Supplement. Pages which are affected by the current revision will carry the date of that revision.

| <u>Revision Level</u> | <u>Date of Issue</u> |
|-----------------------|----------------------|
| 0 (Original) | Dec. 2, 1996 |

LOG OF EFFECTIVITY

| <u>PAGE</u> | <u>DATE</u> | <u>PAGE</u> | <u>DATE</u> |
|--------------|-------------|-------------|-------------|
| Title (S1-1) | Dec 2/96 | S1-9 | Dec 2/96 |
| S1-2 | Dec 2/96 | S1-10 | Dec 2/96 |
| S1-3 | Dec 2/96 | S1-11 | Dec 2/96 |
| S1-4 | Dec 2/96 | S1-12 | Dec 2/96 |
| S1-5 | Dec 2/96 | S1-13 | Dec 2/96 |
| S1-6 | Dec 2/96 | S1-14 | Dec 2/96 |
| S1-7 | Dec 2/96 | S1-15 | Dec 2/96 |
| S1-8 | Dec 2/96 | S1-16 Blank | Dec 2/96 |

SERVICE BULLETIN CONFIGURATION LIST

The following is a list of Service Bulletins that are applicable to the operation of the airplane, and have been incorporated into this supplement. This list contains only those Service Bulletins that are currently active.

| <u>Number</u> | <u>Title</u> | <u>Airplane Unit Effectivity</u> | <u>Revision Incorporation</u> | <u>Incorporated In Airplane</u> |
|---------------|--------------|--|-----------------------------------|-------------------------------------|
|---------------|--------------|--|-----------------------------------|-------------------------------------|

SUPPLEMENT

BENDIX/KING KX 155A NAV/COMM with KI 208 or KI 209A INDICATOR HEAD

SECTION 1 GENERAL

The Bendix/King KX 155A Nav/Comm, shown in Figure 1, consists of a panel-mounted receiver-transmitter and a KI 208 or KI 209A Indicator.

The set includes a 760-channel VHF communications receiver-transmitter and a 200-channel VHF navigation receiver. A 40-channel glide-slope receiver is also included if the KI 209A indicator is used. The communications receiver-transmitter receives and transmits signals between 118.00 and 136.975 MHz with 25-kHz spacing. Optional 8.33 kHz (2280 channel) Comm is available. The navigation receiver receives VOR and localizer signals between 108.00 and 117.95 MHz in 50-kHz steps. The glide slope receiver is automatically tuned when a localizer frequency is selected. The circuits required to interpret the VOR and localizer signals are also an integral part of the Nav receiver.

Large self-dimming gas discharge readouts display both the communications and navigation operating frequencies. The KX-155A's "flip-flop" preselect feature enables you to store one frequency in the standby display while operating on another and then interchange them instantly with the touch of a button. Both the active (COMM) and the standby (STBY) frequencies may be displayed at all times and are stored in nonvolatile memory without drain on the aircraft battery. KX 155A has 32 programmable comm channels, a stuck microphone alert and transmitter shutdown, Bearing To/From radial mode, course deviation indicator mode and an elapsed timer mode.

The Comm portion incorporates an automatic squelch. To override the automatic squelch, the Comm volume control knob is pulled out. Push the knob back in to reactivate the automatic squelch. A "T" will be displayed during transmit and "R" during valid signal reception.

The Nav portion uses the pull out feature of the Nav volume control to receive the Nav signal ident. Pull the volume control knob out to hear the ident signal plus voice. Push the knob in to attenuate the ident signal and still hear Nav voice.



All controls for the Nav/Comm, except those for navigation course selection, are mounted on the front panel of the receiver-transmitter. Control lighting is provided by NAV/COMM interior lighting and the instrument panel flood lighting system. Operation and description of the audio selector panel used in conjunction with this radio is shown and described in Supplement 3 in this section.

NOTE

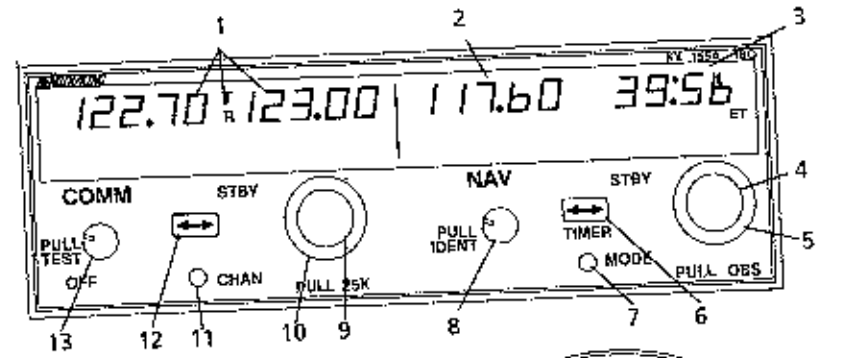
The unit has a stuck microphone alert feature. If the microphone is keyed continuously for greater than 33 seconds, the transmitter stops transmitting and the active Comm frequency flashes to alert the pilot of the stuck mic condition.



KX 155A VHF NAV/COMM

-  TO INDICATION
-  FROM INDICATION
-  FLAG INDICATION

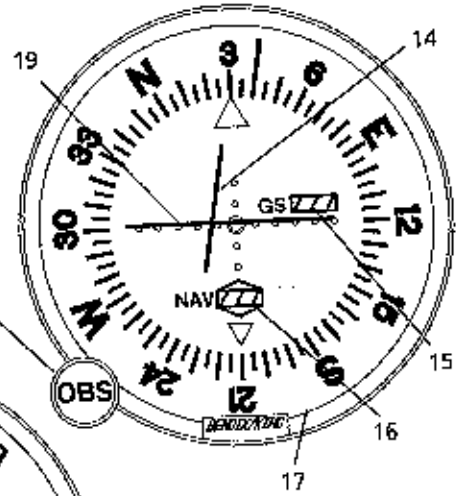

KI 209A INDICATOR

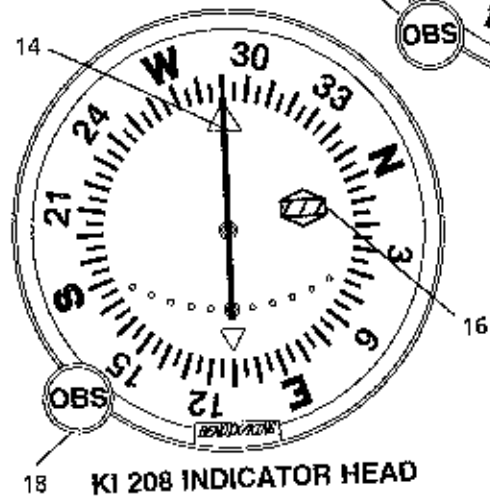

KI 208 INDICATOR HEAD

0585C1045
0586C1046
0585C1047

Figure 1. Bendix/King KX 155A VHF NAV/COMM with KI 208 or KI 209A Indicator Head (Sheet 1 of 7)

NAV FUNCTION DISPLAYS

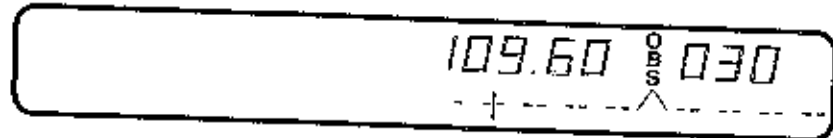

VOR MODE: ACTIVE/BEARING, CDI FORMAT

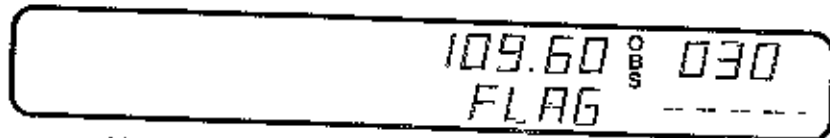

VOR MODE: ACTIVE/BEARING, FLAG DISPLAY



VOR MODE: ACTIVE "BEARING TO" FUNCTION DISPLAY



VOR MODE: ACTIVE/BEARING, FLAG DISPLAY

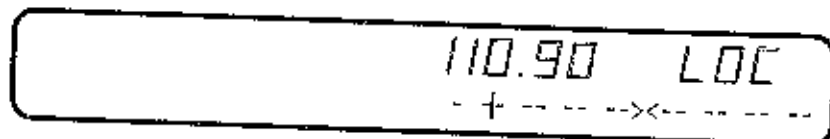

LOCALIZER MODE: FREQUENCY/CDI FORMAT

Figure 1. Bendix/King KX 155A VHF NAV/COMM with KI 208 or
KI 209A Indicator Head (Sheet 2 of 7)

1. OPERATING COMM FREQUENCY DISPLAY -- Displays COMM ACTIVE and COMM STANDBY frequencies with a "T" between them to indicate TRANSMIT and an "R" to indicate RECEIVE modes of operation.
2. OPERATING NAV FREQUENCY DISPLAY -- The right portion of the display is allocated to NAV receiver ACTIVE and STANDBY information. The frequency channeling is similar to the COMM when operating in the frequency mode. The NAV ACTIVE and STANDBY frequencies are stored in the memory on power down and return on power up.
3. NAV STANDBY/OBS/Bearing/Radial/Timer Display -- The right side of the NAV display is controlled by the MODE SELECTOR BUTTON (see #7 below). With an active VOR frequency, this portion of the display shows the STANDBY frequency, OBS setting for the internal CDI, the bearing to the VOR station, radial from the VOR station, or a count-up/count-down timer. With an active localizer frequency, this portion of the display shows the standby frequency, the letters "LOC", or count-up/count-down timer.
4. NAV FREQUENCY SELECTOR KNOB (SMALL) -- Operates in 50 kHz steps. The NAV receiver's lower and upper frequency limits are 108.00 MHz and 117.95 MHz. Exceeding the upper limit of frequency band will automatically return to the lower limit and vice versa. A clockwise rotation will increase (inc) the previous frequency while a counterclockwise rotation will decrease (dec) the previous frequency.
5. NAV FREQUENCY SELECTOR KNOB (LARGE) -- Operates in 1 MHz steps. The frequency inc/dec operates the STANDBY frequency display. A clockwise rotation will increase the previous frequency while a counterclockwise rotation will decrease the previous frequency. Exceeding the upper limit of the frequency band will automatically return to the lower limit and vice versa.

Figure 1. Bendix/King KX 155A VHF NAV/COMM with KI 208 or KI 209A Indicator Head (Sheet 3 of 7)

6. NAV/FREQUENCY TRANSFER BUTTON (\longleftrightarrow) -- Interchanges the NAV Active and STANDBY frequencies. Depressing the NAV frequency transfer button for 2 seconds or more will cause the display to go in to the ACTIVE ENTRY mode. Only the ACTIVE frequency will be displayed and it can be directly changed by using the NAV inc/dec knobs. The display will return to the ACTIVE/STANDBY mode when the NAV frequency transfer button is pushed.

7. MODE SELECTOR BUTTON -- Depressing the mode button will cause the NAV display to go from the ACTIVE/STANDBY format to the ACTIVE/CDI (Course Deviation Indicator) format. In the CDI mode, the frequency inc/dec knob (pushed in) channels the ACTIVE frequency. When the ACTIVE window is tuned to a VOR frequency, the standby frequency area is replaced by a three digit OBS (Omni Bearing Selector) display. The desired OBS course can be selected by pulling out the inner NAV frequency knob and turning it. This OBS display is independent of any OBS course selected on an external CDI. An "OBS" in the middle of the NAV display will flash while the inner NAV frequency knob is pulled out. The CDI is displayed on the line below the frequency/OBS. When the ACTIVE window is tuned to a localizer frequency, the standby frequency area is replaced by "LOC". When the received signal is too weak to ensure accuracy the display will "FLAG".

Depressing the mode button again will cause the NAV display to go from the ACTIVE/CDI format to the ACTIVE/BEARING format. In the BEARING mode, the frequency inc/dec knob channels the ACTIVE frequency window. Depressing the frequency transfer button will cause the ACTIVE frequency to be placed in blind storage and the STANDBY frequency (in blind storage) to be displayed in the ACTIVE window display. In bearing mode, the right hand window of the NAV display shows the bearing TO the station. When a too weak or invalid VOR signal is received the display flags (dashes).

Figure 1. Bondix/King KX 155A VHF NAV/COMM with KI 208 or KI 209A Indicator Head (Sheet 4 of 7)

Another push of the mode button will cause the NAV display to go from the ACTIVE/BEARING format to the ACTIVE/RADIAL format. In the RADIAL mode, the frequency inc/dec knobs channel the ACTIVE frequency window and depressing the frequency transfer button will cause the ACTIVE frequency to be placed in blind storage and the STANDBY frequency (in blind storage) to be displayed in the ACTIVE window display. In radial mode of operation, the right hand window of NAV display shows the radial FROM the station. When a too weak or invalid VOR signal is received the display flags (dashes).

Another push of the mode button will cause the unit to go into the TIMER mode. When the unit is turned on, the elapsed timer (ET) begins counting upwards from zero. The timer can be stopped and reset to zero by pushing the NAV frequency transfer button for 2 seconds or more causing the ET on the display to flash. In this state, the timer can be set as a countdown timer or the elapsed timer can be restarted. The countdown timer is set by using the NAV frequency inc/dec knobs to set the desired time and then pushing the NAV frequency transfer button to start the timer. The large knob selects minutes, the small knob in the "in" position selects 10 second intervals, and the small knob in the "out" position selects individual seconds. After the countdown timer reaches zero, the counter will begin to count upwards indefinitely while flashing for the first 15 seconds. When the elapsed timer is reset to zero it may be restarted again by momentarily pushing the NAV frequency transfer button.

8. NAV/VOLUME CONTROL (PULL IDENT) -- Adjusts volume of navigation receiver audio. When the knob is pulled out, the Ident signal plus voice may be heard. The volume of voice/ident can be adjusted by turning this knob.

Figure 1. Bendix/King KX 155A VHF NAV/COMM with KI 208 or KI 209A Indicator Head (Sheet 5 of 7)

9. COMM FREQUENCY SELECTOR KNOB (INNER) -- This smaller knob is designed to change the indicated frequency in steps of 50-kHz when it is pushed in, and in 25-kHz steps when it is pulled out. For 8.33 kHz versions, channels are incremented in 25 kHz steps with the knob pushed in and 8.33 kHz with the knob pulled out.
10. COMM FREQUENCY SELECTOR KNOB (OUTER) -- The outer, larger selector knob is used to change the MHz portion of the frequency display. At either band-edge of the 118-136 MHz frequency spectrum, an offscale rotation will wrap the display around to the other frequency band-edge (i.e., 136 MHz advances to 118 MHz).
11. CHANNEL BUTTON -- Pressing the CHAN button for 2 or more seconds will cause the unit to enter the channel program (PG) mode. Upon entering the channel program mode, the channel number will flash indicating that it can be programmed. The desired channel can be selected by turning the comm kHz knob. The channel frequency can be entered by pushing the comm transfer button which will cause the standby frequency to flash. The comm frequency knobs are then used to enter the desired frequency. If dashes (located between 136 MHz and 118 MHz) are entered instead of a frequency, the corresponding channel is skipped in channel selection mode. Additional channels may be programmed by pressing the COMM transfer button and using the same procedure. The channel information is saved by pushing the CHAN button which will also cause the unit to return to the previous frequency entry mode.

The channel selection mode (CH) can then be entered by momentarily pushing the CHAN button. The comm frequency knobs can be used to select the desired channel. The unit will automatically default to the previous mode if no channel is selected within 2 seconds after entering the channel selection mode. The unit is placed in the transmit mode by depressing a mic button.

Figure 1. Bendix/King KX 155A VHF NAV/COMM with KI 208 or KI 209A Indicator Head (Sheet 6 of 7)

12. COMM FREQUENCY TRANSFER BUTTON (\longleftrightarrow) --

interchanges the frequencies in the USE and STANDBY displays. To tune the radio to the desired operating frequency, the desired frequency must be entered into the standby display and then the transfer button must be pushed. This will trade the contents of the active and standby displays. The operating frequency can also be entered by accessing the ACTIVE ENTRY (direct tune) mode which is done by pushing the COMM TRANSFER button for 2 or more seconds. In the direct tune mode, only the active part of the display is visible. The desired frequency can be directly entered into the display. Push the COMM TRANSFER button again to return to the active/standby display.

The transceiver is always tuned to the frequency appearing in the ACTIVE display. It is, therefore, possible to have two different frequencies stored in the ACTIVE and STANDBY displays and to change back and forth between them at the simple push of the transfer button.

13. COMM VOLUME CONTROL (OFF/PULL/TEST) -- Rotate the VOL knob clockwise from the OFF position. Pull the VOL knob out and adjust for desired listening level. Push the VOL knob back in to actuate the automatic squelch. The VOL knob may also be pulled out to hear particularly weak signals.

14. VOR/Localizer Needle or CDI needle.

15. Glideslope Flag

16. TO-FROM-NAV FLAG

17. Azimuth Card

18. OBS Knob

19. Glideslope Needle

Figure 1. Bendix/King KX 155A VHF NAV/COMM with KI 208 or KI 209A Indicator Head (Sheet 7 of 7)

SECTION 2 LIMITATIONS

There is no change to the airplane limitations when this avionic equipment is installed.

SECTION 3 EMERGENCY PROCEDURES

There is no change to the airplane emergency procedures when this avionic equipment is installed. However, if the frequency readouts fail, the radio will remain operational on the last frequency selected. If either frequency transfer button is pressed and held while power is applied to the unit, the unit wakes up with 120.00 MHz in the COMM use frequency and 110.00 MHz in the NAV active frequency, with both COMM and NAV in the active entry mode. This will aid the pilot in blind tuning the radio.

SECTION 4 NORMAL PROCEDURES

COMMUNICATION RECEIVER-TRANSMITTER OPERATION:

1. OFF/PULL/TEST Volume Control -- Turn clockwise; pull out and adjust to desired audio level; push control back in to activate the automatic squelch.
2. MIC Selector Switch (on audio control panel) -- SET to COMM 1.
3. SPEAKER Selector (on audio control panel) -- SET to desired mode.
4. COMM Frequency Selector Knobs -- Select desired operating frequency.
5. COMM Transfer Button -- PRESS to transfer desired frequency from the STBY display into the COMM display.

6. Mic Button:
a. To transmit -- Press button and speak in microphone.

NOTE

During COMM transmission, a lighted "T" will appear between the "COMM" and "STBY" displays to indicate that the transceiver is operating in the transmit code.

- b. To Receive -- RELEASE mike button.

NAVIGATION RECEIVER OPERATION:

1. NAV Frequency Selector Knobs -- SELECT desired operating frequency in "STBY" display.
2. NAV TRANSFER BUTTON -- PRESS to transfer desired frequency from the "STBY" display into the "NAV" display.
3. Speaker Selector (on audio control panel) -- SET to desired mode..
4. NAV Volume Control --
 - a. ADJUST to desired audio level.
 - b. PULL out to identify station.

VOR OPERATION:

Channel the NAV Receiver to the desired VOR and monitor the audio to positively identify the station. To select an OBS course, turn the OBS knob to set the desired course under the lubber line. When a signal is received, the NAV flag will pull out of view and show a "TO" or "FROM" flag as appropriate for the selected course.

LOC OPERATION

Localizer circuitry is energized when the NAV Receiver is channeled to an ILS frequency. Monitor the LOC audio and positively identify the station. The NAV flag will be out of view when the signal is of sufficient strength to be usable.

GLIDESLOPE OPERATION

The glideslope receiver is automatically channeled when a localizer frequency is selected. A separate warning flag is provided to indicate usable signal conditions.

PILOT CONFIGURATION

This mode can be accessed by pressing and holding the NAV Mode Button for more than 2 seconds and then pressing the Nav Frequency Transfer Button for an additional 2 seconds, while continuing to hold the NAV Mode Button. When the Pilot Config Mode is entered the unit will show the "SWRV" mnemonic which is the unit software revision level. Adjustment pages can be accessed by MODE button presses.

The pilot may adjust two parameters in the pilot configuration, the display minimum brightness and sidetone volume level. Minimum Brightness (BRIM) will have a range of 0-255. The dimmest is 0 and the brightest is 255. Sidetone volume level is adjusted when SIDE is displayed. Values from 0-255 may be selected with 0 being least volume, 255 being the greatest.

| Adjustment | Mnemonic | Min Level | Max Level |
|----------------------------|----------|-----------|-----------|
| Software Revision Number | SWRV | --- | --- |
| Minimum Display Brightness | BRIM | 0 | 255 |
| Sidetone Level | SIDE | 0 | 255 |

CESSNA
MODEL 172R

SECTION 9 - SUPPLEMENTS
SUPPLEMENT 1 - FAA APPROVED

Subsequent presses of the MODE button sequences through SWRV, BRIM, SIDE, and then back to SWRV.

Pressing the NAV Transfer Button momentarily exits Pilot configuration mode. The NAV returns to its pre-Pilot Config state with the new brightness and sidetone levels stored in nonvolatile memory.

**SECTION 5
PERFORMANCE**

There is no change to the airplane performance when this avionic equipment is installed. However, the installation of an externally mounted antenna, or several related antennas, will result in a minor reduction in cruise performance.

Dec 2/96

S1-15/(S1-16 Blank)





**Pilot's Operating Handbook and
FAA Approved Airplane Flight Manual**

**CESSNA MODEL 172R
AIRPLANES 80001 AND ON**

SUPPLEMENT 3

**BENDIX/KING KMA 25
AUDIO SELECTOR PANEL**

| |
|------------------------|
| SERIAL NO. _____ |
| REGISTRATION NO. _____ |

This supplement must be inserted into Section 9 of the Pilot's Operating Handbook and FAA Approved Airplane Flight Manual.

| |
|---|
| FAA APPROVAL FAA APPROVED UNDER FAR 21 SUBPART J The Cessna Aircraft Co Delegation Option Manufacturer CE-1 <i>Michael D. Hedberg</i> Executive Engineer Date: December 10, 1996 |
|---|

 Member of GAMA
2 December 1996

COPYRIGHT © 1996
CESSNA AIRCRAFT COMPANY
WICHITA, KANSAS, USA

17:RPHUS-53-00

S3-1

SUPPLEMENT 3

BENDIX/KING KMA 26 AUDIO SELECTOR PANEL

The following Log of Effective Pages provides the date of issue for original and revised pages, as well as a listing of all pages in the Supplement. Pages which are affected by the current revision will carry the date of that revision.

| <u>Revision Level</u> | <u>Date of Issue</u> |
|-----------------------|----------------------|
| 0 (Original) | Dec. 2, 1996 |

LOG OF EFFECTIVITY

| <u>PAGE</u> | <u>DATE</u> | <u>PAGE</u> | <u>DATE</u> |
|--------------|-------------|-------------|-------------|
| Title (S3-1) | Dec 2/96 | S3-5 | Dec 2/96 |
| S3-2 | Dec 2/96 | S3-6 | Dec 2/96 |
| S3-3 | Dec 2/96 | S3-7 | Dec 2/96 |
| S3-4 | Dec 2/96 | S3-8 | Dec 2/96 |

SERVICE BULLETIN CONFIGURATION LIST

The following is a list of Service Bulletins that are applicable to the operation of the airplane, and have been incorporated into this supplement. This list contains only those Service Bulletins that are currently active.

| <u>Number</u> | <u>Title</u> | <u>Airplane Unit Effectivity</u> | <u>Revision Incorporation</u> | <u>Incorporated In Airplane</u> |
|---------------|--------------|--|-----------------------------------|-------------------------------------|
|---------------|--------------|--|-----------------------------------|-------------------------------------|

SUPPLEMENT

BENDIX/KING KMA 26 AUDIO SELECTOR PANEL

SECTION 1 GENERAL

The Bendix/King KMA 26 Audio Selector Panel is a combination audio amplifier, an audio distribution panel intercom, and a marker beacon receiver. The audio amplifier is for amplification of the audio signals for the speaker system. All receiver audio distribution functions are controlled by two rows of pushbuttons. A rotary selector switch on the right side of the console connects the microphone to either EMG, Com 1, Com 2, Com 3 or PA (Unused position). All operating controls are shown and described in Figure 1.

A crystal-controlled superheterodyne marker beacon receiver with 3-light presentation is incorporated within the unit. Dimming circuitry for the marker lamps automatically adjusts brightness appropriate to the cockpit ambient light level. Hi and Lo sensitivity and lamp test functions are also provided.

Light dimming for the audio control panel is manually controlled by the RADIO light rheostat knob.

MARKER FACILITIES

| MARKER | IDENTIFYING TONE | LIGHT* |
|---------------------------|-------------------------------------|--------|
| Inner, Airway & Fan | Continuous 6 dots/sec (3000 Hz) | White |
| Middle | Alternate dots and dashes (1300 Hz) | Amber |
| Outer | 2 dashes/sec (400 Hz) | Blue |

*When the identifying tone is keyed, the respective indicating light will blink accordingly.

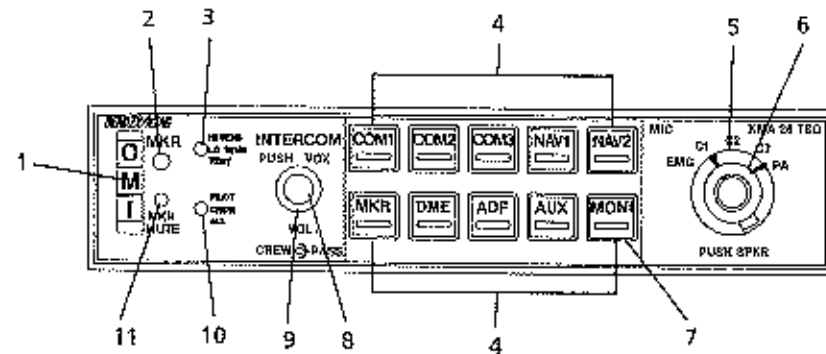

1. MARKER BEACON ANNUNCIATOR LIGHTS -- The three-light marker beacon receiver built into the KMA 26 gives a visual and aural signal when the ship's antenna passes over a 75 MHz beacon. The blue, amber, and white lights on the faceplate, as well as the audio tones, identify the beacon type.

INNER, AIRWAY and FAN -- Light illuminates white to indicate passage of ILS inner, airway or fan marker beacons.

OUTER -- Light illuminates blue to indicate passage of outer marker beacon.

MIDDLE -- Light illuminates amber to indicate passage of middle marker beacon.

2. PHOTOCELL FOR AUTOMATIC DIMMING OF MARKER BEACON LIGHTS AND SELECT BUTTON -- The photocell in the faceplate automatically dims the marker lights as well as the green annunciators in the Speaker Audio Select Buttons for night operation.

3. MARKER BEACON SENSITIVITY LAMP AND TEST SWITCH --The "MKR" Audio Select button must be pushed so that the green annunciator is illuminated for the marker beacon to receive to provide an audio signal at beacon passage. When this switch is on "HI SENS" (upper) position, the high sensitivity is selected which permits you to hear the outer marker tone about a mile out. At this point you may select the the "LO SENS" (middle) position to temporarily silence the tone. It will start to sound again when you are closer to the marker, giving you a more precise indication of its location.

Figure 1. Bendix/King KMA 26 Audio Selector Panel (Sheet 1 of 3)

4. AUDIO SELECT BUTTONS -- Push button audio selection is available for three Communications receivers ("COM 1", "COM 2", and "COM 3"), two Navigation receivers ("NAV 1" and "NAV 2"), the internal Marker Beacon receiver ("MKR"), one DME, one ADF, and one additional auxiliary receiver ("AUX"). The "AUX" position could be used, for example, for a second DME or ADF. When a receiver's audio is selected, the green annunciator illuminates at the bottom of the button. Push the button again to deselect the receiver's audio.
5. MICROPHONE SELECTOR SWITCH (MIC) -- Used to select the desired transmitter for the cockpit microphones. The "C1", "C2", and "C3" positions are for transmitting on the Com 1, Com 2, and Com 3 communications transceivers, respectively. The "EMG" (emergency) position is used to bypass the KMA 26's audio amplifier and directly connects Com 1 to the pilot's microphone and headphones. This provides a fail-safe method of communication should the unit fail. The "PA" position may be selected when the aircraft is configured with a passenger address capability. The "Auto Com" feature always provides automatic headphone audio selection to match the Com transmitter in use. To add speaker audio, simply push the Speaker Select Switch (inner right knob) to the "in" position. Pulling the switch to the "out" position removes speaker audio.
6. SPEAKER SELECT (PUSH SPKR) SWITCH -- With the Speaker Select Switch pushed in, both headphone and cabin speaker audio will be heard. Headphone audio is active full-time. Headphone audio cannot be deselected.
7. MONITOR SELECT (MONI) BUTTON -- When activated, if Com 1 is selected on the Microphone Selector Switch then Com 2 audio is automatically routed to the speaker. Or if Com 2 is selected on the Microphone Selector Switch, then Com 1 is routed to the speaker. Pressing the "MONI" button again will disable the feature. Initially when "MONI" is selected the green annunciators in the button flash for approximately 5 seconds, then remains steady while the Com annunciation returns to its previous state.
8. CREW INTERCOM VOLUME (VOL CREW) KNOB and INTERCOM VOX SENSITIVITY SET (INTERCOM PUSH VOX) SWITCH -- Inside knob adjusts Pilot and Copilot intercom volume. Intercom operation is voice activated (VOX), where intercom becomes active automatically when a crew member or passenger begins to speak. Set the intercom VOX squelch by momentarily pressing and releasing the left inner knob when no one is speaking.

Figure 1. Bendix/King KMA 26 Audio Selector Panel (Sheet 2 of 3)

9. PASSENGER INTERCOM VOLUME (VOL PASS) KNOB -- Adjusts passenger intercom volume.
10. INTERCOM MODE SELECT SWITCH -- Has three modes "ALL", "CREW", AND "PILOT" which are selected with the toggle switch on the lower left side on the faceplate. In the "ALL" position the pilot, copilot, and passengers are all on the same intercom "loop" and everyone hears the radios. In the "CREW" position the pilot and copilot are on one intercom loop and can hear the radios while the passengers have their own dedicated intercom and do not hear the radios. In the "PILOT" mode the pilot hears the radios but is isolated from the intercom while the copilot and passengers are on the same intercom loop and do not hear the radios.

When either the "ALL" or "CREW" intercom modes are selected, the pilot's and copilot's intercom volume is controlled by rotating the Crew Intercom Volume Knob (left inner knob) while the passenger's volume is controlled by rotating the Passenger Intercom Volume Knob (left outer knob). When the "PILOT" intercom mode is selected, the copilot's and passenger's volume is controlled with the Passenger Intercom Volume Knob. Remember, the volume knobs on the KMA 26 control intercom volume only, not the receiver's volume.

11. MARKER MUTE BUTTON -- Mutes currently active marker beacon audio.

Figure 1. Bendix/King KMA 26 Audio Selector Panel (Sheet 3 of 3)

SECTION 2 LIMITATIONS

There is no change to the airplane limitations when this avionic equipment is installed.

SECTION 3 EMERGENCY PROCEDURES

In the event of an audio amplifier in the KMA 26, as evidenced by the inability to transmit in COM 1, 2 or 3.

1. MIC Selector Switch -- EMG.

NOTE

This action bypasses the KMA 26 audio amplifier and connects the pilot's mic/head set directly to COM 1.

SECTION 4 NORMAL PROCEDURES

AUDIO CONTROL SYSTEM OPERATION:

1. MIC Selector Switch -- Turn to desired transmitter.
2. SPEAKER and Audio Select Button(s) -- SELECT desired receiver(s).

NOTES

Rotation of the MIC selector switch selects the Com audio automatically.

MARKER BEACON RECEIVER OPERATION:

1. TEST Position -- HOLD toggle down momentarily to verify all lights are operational.
2. SENS Selections -- Select Hf sensitivity for airway flying or LO for ILS/LOC approaches.

**SECTION 5
PERFORMANCE**

There is no change to the airplane performance when this avionic equipment is installed. However, the installation of an externally mounted antenna or related external antennas, will result in a minor reduction in cruise performance.



**Pilot's Operating Handbook and
FAA Approved Airplane Flight Manual**

**CESSNA MODEL 172R
AIRPLANES 80001 AND ON**

SUPPLEMENT 4

**POINTER MODEL 3000-11
EMERGENCY LOCATOR TRANSMITTER**

| |
|------------------------|
| SERIAL NO. _____ |
| REGISTRATION NO. _____ |

This supplement must be inserted into Section 9 of the Pilot's Operating Handbook and FAA Approved Airplane Flight Manual.

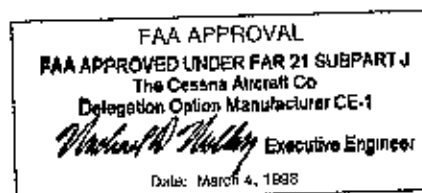

 Member of GAMA

2 December 1996

Revision 1 - 3 November 1997

COPYRIGHT © 1996
CESSNA AIRCRAFT COMPANY
WICHITA, KANSAS, USA

172RPHUS-S4-01

S4-1

SUPPLEMENT 4

POINTER MODEL 3000-11 EMERGENCY LOCATOR TRANSMITTER (ELT)

The following Log of Effective Pages provides the date of issue for original and revised pages, as well as a listing of all pages in the Supplement. Pages which are affected by the current revision will carry the date of that revision

| <u>Revision Level</u> | <u>Date of Issue</u> |
|-----------------------|----------------------|
| 0 (Original) | Dec. 2, 1996 |
| 1 | Nov. 3, 1997 |

LOG OF EFFECTIVITY PAGES

| <u>PAGE</u> | <u>DATE</u> | <u>PAGE</u> | <u>DATE</u> |
|--------------|-------------|-------------|-------------|
| Title (S4-1) | Nov 3/97 | S4-5 | Dec 2/96 |
| S4-2 | Nov 3/97 | S4-6 | Dec 2/96 |
| S4-3 | Nov 3/97 | S4-7 | Dec 2/96 |
| S4-4 | Dec 2/96 | S4-8 | Dec 2/96 |

SERVICE BULLETIN CONFIGURATION LIST

The following is a list of Service Bulletin that are applicable to the operation of the airplane, and have been incorporated into this supplement. This list contains only those Service Bulletin that are currently active.

| <u>Number</u> | <u>Title</u> | <u>Airplane Unit Effectivity</u> | <u>Revision Incorporation</u> | <u>Incorporated in Airplane</u> |
|---------------|--------------|--|-----------------------------------|-------------------------------------|
|---------------|--------------|--|-----------------------------------|-------------------------------------|

SUPPLEMENT

POINTER MODEL 3000-11 EMERGENCY LOCATOR TRANSMITTER (ELT)

SECTION 1

GENERAL

This supplement provides information which must be observed when operating the Pointer Model 3000-11 Emergency Locator Transmitter.

The Pointer Model 3000-11 ELT consists of a self-contained dual-frequency solid-state transmitter powered by a battery pack consisting of five alkaline "C" cell batteries and is automatically activated by a deceleration sensing inertia "G" switch, which is designed to activate when the unit senses longitudinal inertia forces as required in TSO-C91A. Also, a remote switch/annunciator is installed on the top right hand side of the copilot's instrument panel for control of the ELT from the flight crew station. The annunciator, which is in the center of the rocker switch, illuminates when the ELT transmitter is transmitting. The ELT emits an omni-directional signal on the international distress frequencies of 121.5 MHz and 243.0 MHz. General aviation and commercial aircraft, the FAA and CAP monitor 121.5 MHz, and 243.0 MHz is monitored by the military.

The ELT is contained in a high impact, fire retardant, glass filled Lexon case with carrying handle and is mounted behind the aft cabin partition wall on the right side of the tailcone. To gain access to the unit, unfasten the turn fasteners on the aft cabin partition. The ELT is operated by a control panel at the forward facing end of the unit or by the remote switch/annunciator located on the top right hand portion of the copilot's instrument panel (see Figure 1).

Power for the transmitter is provided by an alkaline battery pack inside the transmitter case.

SECTION 9 - SUPPLEMENTS
SUPPLEMENT 4 - FAA APPROVED

CESSNA
MODEL 172R

In accordance with FAA regulations, the ELT's battery pack must be replaced after 2 years shelf or service life or for any of the following reasons:

- a. After the transmitter has been used in an emergency situation (including any inadvertent activation of unknown duration).
- b. After the transmitter has been operated for more than one cumulative hour (e.g. time accumulated in several tests and inadvertent activation of known duration).
- c. On or before battery replacement date. Battery replacement date is marked on the battery pack and the label on the transmitter.

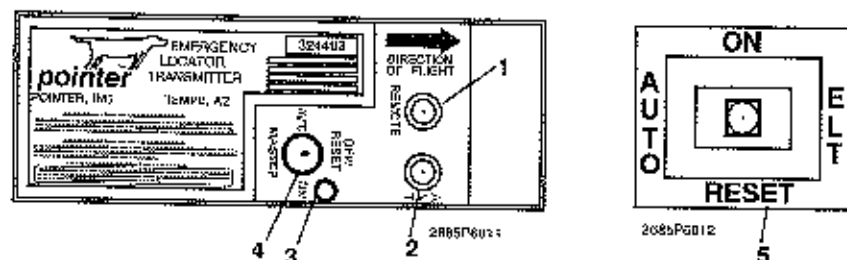

1. REMOTE CABLE JACK -- Connects to ELT remote switch/annunciator located on the copilot's instrument panel.
2. ANTENNA RECEPTACLE -- Connects to antenna mounted on top of tailcone.
3. TRANSMITTER ANNUNCIATOR LIGHT -- Illuminates red to indicate the transmitter is transmitting a distress signal.
4. MASTER FUNCTION SELECTOR SWITCH (3-position toggle switch):
 - AUTO -- Arms transmitter for automatic activation if "G" switch senses a predetermined deceleration level.
 - ON -- Activates transmitter instantly. Used for test purposes and if "G" switch is inoperative. The ON position bypasses the automatic activation switch. (The red annunciator in the center of the remote switch/annunciator should illuminate).

- OFF/RESET -- Deactivates transmitter during handling, following rescue and to reset the automatic activation function. (The red annunciator in the center of the remote switch/annunciator should extinguish).
5. REMOTE SWITCH/ANNUNCIATOR (3-position rocker switch):
- ON -- Remotely activates the transmitter for test or emergency situations. Red annunciator in center of rocker switch illuminates to indicate that the transmitter is transmitting a distress signal.
- AUTO -- Arms transmitter for automatic activation if "G" switch senses a predetermined deceleration level.
- RESET -- Deactivates and rearms transmitter after automatic activation by the "G" switch. Red annunciator in center of rocker switch should extinguish.

SECTION 2 LIMITATIONS

Refer to Section 2 of the Pilot's Operating Handbook (POH).

SECTION 3 EMERGENCY PROCEDURES

Before performing a forced landing, especially in remote and mountainous areas, activate the ELT transmitter by positioning the remote switch/annunciator to the ON position. The annunciator in center of the rocker switch should be illuminated.

Immediately after a forced landing where emergency assistance is required, the ELT should be utilized as follows:

NOTE

The ELT remote switch/annunciator system could be inoperative if damaged during a forced landing. If inoperative, the inertia "G" switch will activate automatically. However, to turn the ELT OFF and ON again requires manual switching of the master function selector switch which is located on the ELT unit.

1. ENSURE ELT ACTIVATION:
 - a. Position remote switch/annunciator to the ON position even if annunciator light is already on.
 - b. If airplane radio is operable and can be safely used (no threat of fire or explosion), turn ON and select 121.5 MHz. If the ELT can be heard transmitting, it is working properly.
 - c. Ensure that antenna is clear of obstructions.

NOTE

When the ELT is activated, a decreasing tone will be heard before the typical warbling tone begins.

2. PRIOR TO SIGHTING RESCUE AIRCRAFT -- Conserve airplane battery. Do not activate radio transceiver.
3. AFTER SIGHTING RESCUE AIRCRAFT -- Position remote switch/annunciator to the RESET position and release to the AUTO position to prevent radio interference. Attempt contact with rescue aircraft with the radio transceiver set to a frequency of 121.5 MHz. If no contact is established, return the remote switch/annunciator to the ON position immediately.
4. FOLLOWING RESCUE -- Position remote switch/annunciator to the AUTO position, terminating emergency transmissions.

**SECTION 4
NORMAL PROCEDURES**

As long as the remote switch/annunciator is in the AUTO position and the ELT master function selector switch remains in the AUTO position, the ELT automatically activates when the unit senses longitudinal inertia forces as required in TSO-C91A.

Following a lightning strike, or an exceptionally hard landing, the ELT may activate although no emergency exists. If the remote switch/annunciator illuminates, the ELT has inadvertently activated itself. Another way to check is to select 121.5 MHz on the radio transceiver and listen for an emergency tone transmission. If the remote switch/annunciator is illuminated or an emergency tone is heard, position the remote switch/annunciator in the RESET position and release to the AUTO position.

The ELT must be serviced in accordance with FAR Part 91.207.

INSPECTION/TEST

1. The emergency locator transmitter should be tested every 100 hours.

NOTE

Test should only be conducted within the first 5 minutes of each hour.

2. Disconnect antenna cable from ELT.
3. Turn airplane battery switch and avionics power switches ON.
4. Turn airplane transceiver ON and set frequency to 121.5 MHz.
5. Place remote switch/annunciator in the ON position. The annunciator should illuminate. Permit **only three** emergency tone transmissions, then immediately reposition the remote switch/annunciator to the RESET position and release to the AUTO position.
6. Place the ELT master function selector switch in the ON position. Verify that the transmitter annunciator light on the ELT and the remote switch/annunciator on the instrument panel are illuminated.
7. Place the ELT master function selector switch in the OFF/RESET position.
8. Reposition ELT master function selector switch to AUTO.
9. Reconnect antenna cable to ELT.

⚠ WARNING

A TEST WITH THE ANTENNA CONNECTED SHOULD BE APPROVED AND CONFIRMED BY THE NEAREST CONTROL TOWER.

NOTE

Without its antenna connected, the ELT will produce sufficient signal to reach the airplane transceiver, yet it will not disturb other communications or damage output circuitry.

IN-FLIGHT MONITORING AND REPORTING

Pilot's are encouraged to monitor 121.5 MHz and/or 243.0 MHz while in flight to assist in identifying possible emergency ELT transmissions. On receiving a signal, report the following information to the nearest air traffic control facility:

1. Your position at the time the signal was first heard.
2. Your position at the time the signal was last heard.
3. Your position at maximum signal strength.
4. Your flight altitude and frequency on which the emergency signal was heard -- 121.5 MHz or 243.0 MHz. If possible, positions should be given relative to a navigation aid. If the aircraft has homing equipment, provide the bearing to the emergency signal with each reported position.

SECTION 5 PERFORMANCE

There is no change in airplane performance when the ELT is installed.



**Pilot's Operating Handbook and
FAA Approved Airplane Flight Manual**

**CESSNA MODEL 172R
AIRPLANES 80001 AND ON**

SUPPLEMENT 6

**BENDIX/KING KR87
AUTOMATIC DIRECTION FINDER**

| |
|------------------------|
| SERIAL NO. _____ |
| REGISTRATION NO. _____ |

This supplement must be inserted into Section 9 of the Pilot's Operating Handbook and FAA Approved Airplane Flight Manual when the Automatic Direction Finder is installed.

| |
|---|
| FAA APPROVAL FAA APPROVED UNDER FAR 21 SUBPART J The Cessna Aircraft Co Delegation Option Manufacturer CE-1 <i>Richard W. Woddy</i> Executive Engineer Date: December 16, 1996 |
|---|

 Member of GAMA
2 December 1996

COPYRIGHT © 1986
CESSNA AIRCRAFT COMPANY
WICHITA, KANSAS, USA

172RPHUS-86-00

S6-1

SUPPLEMENT 6

BENDIX/KING KR 87 ADF AUTOMATIC DIRECTION FINDER

The following Log of Effective Pages provides the date of issue for original and revised pages, as well as a listing of all pages in the Supplement. Pages which are affected by the current revision will carry the date of that revision

| <u>Revision Level</u> | <u>Date of Issue</u> |
|-----------------------|----------------------|
| 0 (Original) | Dec. 2, 1996 |

LOG OF EFFECTIVITY PAGE

| <u>PAGE</u> | <u>DATE</u> | <u>PAGE</u> | <u>DATE</u> |
|--------------|-------------|-------------|-------------|
| Title (S6-1) | Dec 2/96 | S6-7 | Dec 2/96 |
| S6-2 | Dec 2/96 | S6-8 | Dec 2/96 |
| S6-3 | Dec 2/96 | S6-9 | Dec 2/96 |
| S6-4 | Dec 2/96 | S6-10 | Dec 2/96 |
| S6-5 | Dec 2/96 | S6-11 | Dec 2/96 |
| S6-6 | Dec 2/96 | S6-12 | Dec 2/96 |

SERVICE BULLETIN CONFIGURATION LIST

The following is a list of Service Bulletins that are applicable to the operation of the airplane, and have been incorporated into this supplement. This list contains only those Service Bulletins that are currently active.

| <u>Number</u> | <u>Title</u> | <u>Airplane Unit Effectivity</u> | <u>Revision Incorporation</u> | <u>Incorporated In Airplane</u> |
|---------------|--------------|--------------------------------------|-----------------------------------|-------------------------------------|
|---------------|--------------|--------------------------------------|-----------------------------------|-------------------------------------|

SUPPLEMENT

BENDIX/KING KR 87 ADF AUTOMATIC DIRECTION FINDER

SECTION 1 GENERAL

The Bendix/King Digital ADF is a panel-mounted, digitally tuned automatic direction finder. It is designed to provide continuous 1-kHz digital tuning in the frequency range of 200-kHz to 1799-kHz and eliminates the need for mechanical band switching. The system is comprised of a receiver, a built-in electronics timer, a bearing indicator, and a KA-44B combined loop and sense antenna. Operating controls and displays for the Bendix/King Digital ADF are shown and described in Figure 1. The audio system used in conjunction with this radio for speaker-phone selection is shown and described in Supplement 3 of this handbook.

The Bendix/King Digital ADF can be used for position plotting and homing procedures, and for aural reception of amplitude-modulated (AM) signals.

The "flip-flop" frequency display allows switching between pre-selected "STANDBY" and "ACTIVE" frequencies by pressing the frequency transfer button. Both pre-selected frequencies are stored in a non-volatile memory circuit (no battery power required) and displayed in large, easy-to-read, self-dimming gas discharge numerics. The active frequency is continuously displayed in the left window, while the right window will display either the standby frequency or the selected readout from the built-in electronic timer.

The built-in electronic timer has two separate and independent timing functions. An automatic flight timer that starts whenever the unit is turned on. This timer functions up to 59 hours and 59 minutes. An elapsed timer which will count up or down for up to 59 minutes and 59 seconds. When a preset time interval has been programmed and the countdown reaches :00, the display will flash for 15 seconds. Since both the flight timer and elapsed timer operate independently, it is possible to monitor either one without disrupting the other. The pushbutton controls and the bearing indicators are internally lighted. Intensity is controlled by the RADIO light dimming rheostat.

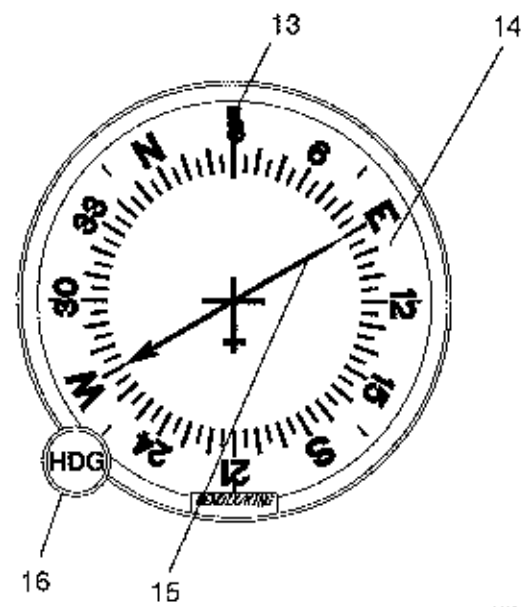
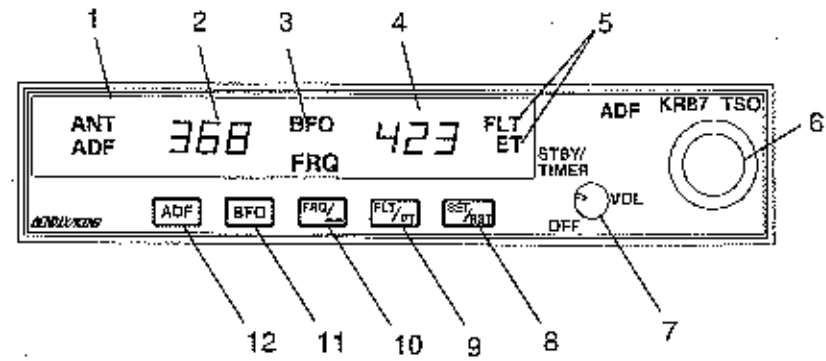

0588C1043
0589C1044

Figure 1. KR 87 Automatic Direction Finder (ADF) (Sheet 1 of 4)

1. **ANT/ADF MODE ANNUNCIATOR** -- Antenna (ANT) is selected by the "out" position of the ADF button. This mode improves the audio reception and is usually used for station identification. The bearing pointer is deactivated and will park in the 90° relative position. Automatic Direction Finder (ADF) mode is selected by the depressed position of the ADF button. This mode activates the bearing pointer. The bearing pointer will point in the direction of the station relative to the aircraft heading.
2. **IN-USE FREQUENCY DISPLAY** -- The frequency to which the ADF is tuned is displayed here. The active ADF frequency can be changed directly when either of the timer functions is selected.
3. **BFO (Beat Frequency Oscillator) ANNUNCIATOR** -- The BFO mode, activated and annunciated when the "BFO" button is depressed, permits the carrier wave and associated morse code identifier broadcast on the carrier wave to be heard.

NOTE

CW signals (Morse Code) are unmodulated and no audio will be heard without use of BFO. This type of signal is not used in the United States air navigation. It is used in some foreign countries and marine beacons.

4. **STANDBY FREQUENCY/FLIGHT TIME OR ELAPSED TIME ANNUNCIATION** -- When FRQ is displayed the STANDBY frequency is displayed in the right hand display. The STANDBY frequency is selected using the frequency select knobs. The selected STANDBY frequency is put into the ACTIVE frequency windows by pressing the frequency transfer button. Either the standby frequency, the flight timer, or the elapsed time is displayed in this position. The flight timer and elapsed timer are displayed replacing the standby frequency which goes into "blind" memory to be called back at any time by depressing the FRQ button. Flight time or elapsed time are displayed and annunciated alternatively by depressing the FLT/ET button.

Figure 1. KR 87 Automatic Direction Finder (ADF) (Sheet 2 of 4)

5. FLIGHT TIMER AND ELAPSED TIMER MODE ANNUNCIATION -- Either the elapsed time (ET) or flight time (FLT) mode is annunciated here.
6. FREQUENCY SELECT KNOBS -- Selects the standby frequency when FRQ is displayed and directly selects the active frequency whenever either of the time functions is selected. The frequency selector knobs may be rotated either clockwise or counterclockwise. The small knob is pulled out to tune the 1's. The small knob is pushed in to tune the 10's. The outer knob tunes the 100's with rollover into the 1000's up to 1799. These knobs are also used to set the desired time when the elapsed timer is used in the countdown mode.
7. ON/OFF/VOLUME CONTROL SWITCH (ON/OFF/VOL) -- Controls primary power and audio output level. Clockwise rotation from OFF position applies primary power to the receiver; further clockwise rotation increases audio level. Audio muting causes the audio output to be muted unless the receiver is locked on a valid station.
8. SET/RESET ELAPSED TIMER BUTTON (SET/RST) -- The set/reset button when pressed resets the elapsed timer whether it is being displayed or not.
9. FLIGHT TIMER/ELAPSED TIMER MODE SELECTOR BUTTON (FLT/ET) -- The Flight Timer/Elapsed Time mode selector button when pressed alternatively selects either Flight Timer mode or Elapsed Timer mode.
10. FREQUENCY TRANSFER BUTTON (FRQ) -- The FRQ transfer button when pressed exchanges the active and standby frequencies. The new frequency becomes active and the former active frequency goes into standby.
11. BFO (Beat Frequency Oscillator) BUTTON -- The BFO button selects the BFO mode when in the depressed position. (See note under item 3).
12. ADF BUTTON -- The ADF button selects either the ANT mode or the ADF mode. The ANT mode is selected with the ADF button in the out position. The ADF mode is selected with the ADF button in the depressed position.

Figure 1. KR 87 Automatic Direction Finder (ADF) (Sheet 3 of 4)

13. LUBBER LINE -- Indicates relative or magnetic heading of the aircraft. The heading must be manually input by the pilot with the heading (HDG) knob.
14. COMPASS CARD -- Manually rotatable card that indicates relative or magnetic heading of aircraft, as selected by HDG knob.
15. BEARING POINTER -- Indicates relative or magnetic bearing to station as selected by HDG knob. If the relative heading of North (N) is manually selected under the lubber line by the pilot, then the bearing pointer indicates the relative bearing to the station. If the aircraft's magnetic heading is selected under the lubber line by the pilot, then the bearing pointer indicates the magnetic bearing to the station.
16. HEADING KNOB (HDG) -- Rotates card to set in relative or magnetic heading of aircraft.

Figure 1. KR 87 Automatic Direction Finder (ADF) (Sheet 4 of 4)

SECTION 2 LIMITATIONS

There is no change to airplane limitations when the KR 87 ADF is installed.

SECTION 3 EMERGENCY PROCEDURES

There are no changes to the basic airplane emergency procedures when the KR 87 ADF is installed.

SECTION 4 NORMAL PROCEDURES

TO OPERATE AS AN AUTOMATIC DIRECTION FINDER:

1. OFF/VOL Control -- ON.
2. Frequency Selector Knobs -- SELECT desired frequency in the standby frequency display.
3. FRQ Button -- PRESS to move the desired frequency from the standby to the active position.
4. ADF Selector Switch (on audio control panel) -- SELECT as desired.
5. OFF/VOL Control -- SET to desired volume level and identify that desired station is being received.
6. ADF Button -- SELECT ADF mode and note relative bearing on indicator.

ADF TEST (PRE-FLIGHT or IN-FLIGHT):

1. ADF Button -- SELECT ANT mode and note pointer moves to 90° position.
2. ADF Button -- SELECT ADF mode and note the pointer moves without hesitation to the station bearing. Excessive pointer sluggishness, wavering or reversals indicate a signal that is too weak or a system malfunction.

TO OPERATE BFO:

1. OFF/VOL Control -- ON.
2. BFO Button -- PRESS on.
3. ADF Selector Buttons (on audio control panel) -- SET to desired mode.
4. VOL Control -- ADJUST to desired listening level.

NOTE

A 1000-Hz tone and Morse Code identifier is heard in the audio output when a CW signal is received.

TO OPERATE FLIGHT TIMER:

1. OFF/VOL Control -- ON.
2. FLT/ET Mode Button -- PRESS (once or twice) until FLT is annunciated. Timer will already be counting since it is activated by turning the unit on.
3. OFF/VOL Control -- OFF and then ON if it is desired to reset the flight timer.

TO OPERATE AS A COMMUNICATIONS RECEIVER ONLY:

1. OFF/VOL Control -- ON.
2. ADF Button -- SELECT ANT mode.
3. Frequency Selector Knobs -- SELECT desired frequency in the standby frequency display.
4. FRQ Button -- PRESS to move the desired frequency from the standby to the active position.
5. ADF Selector Buttons (on audio control panel) -- SET to desired mode.
6. VOL Control -- ADJUST to desired listening level.

TO OPERATE ELAPSED TIME TIMER-COUNT UP MODE:

1. OFF/VOL Control -- ON.
2. FLT/ET Mode Button -- PRESS (once or twice) until ET is annunciated.
3. SET/RST Button -- PRESS momentarily to reset elapsed timer to zero.

NOTE

The Standby Frequency which is in memory while Flight Time or Elapsed Time modes are being displayed may be called back by pressing the FRQ button, then transferred to active use by pressing the FRQ button again.

TO OPERATE ELAPSED TIME TIMER-COUNT DOWN MODE:

1. OFF/VOL Control -- ON.
2. FLT/ET Mode Button -- PRESS (once or twice) until ET is annunciated.
3. SET/RST Button -- PRESS until the ET annunciation begins to flash.
4. FREQUENCY SELECTOR KNOBS -- SET desired time in the elapsed time display. The small knob is pulled out to tune the 1's. The small knob is pushed in to tune the 10's. The outer knob tunes minutes up to 59 minutes.

NOTE

Selector knobs remain in the time set mode for 15 seconds after the last entry or until the SET/RST, FLT/ET or FRQ button is pressed.

5. SET/RST Button -- PRESS to start countdown. When the timer reaches 0, it will start to count up as display flashes for 15 seconds.

NOTE

While FLT or ET are displayed, the active frequency on the left side of the window may be changed, by using the frequency selector knobs, without any effect on the stored standby frequency or the other modes.

CESSNA
MODEL 172R

SECTION 9 - SUPPLEMENTS
SUPPLEMENT 6 - FAA APPROVED

ADF OPERATION NOTES:

ERRONEOUS ADF BEARING DUE TO RADIO FREQUENCY PHENOMENA:

In the U.S., the FCC, which assigns AM radio frequencies, occasionally will assign the same frequency to more than one station in an area. Certain conditions, such as Night Effect, may cause signals from such stations to overlap. This should be taken into consideration when using AM broadcast station for navigation.

Sunspots and atmospheric phenomena may occasionally distort reception so that signals from two stations on the same frequency will overlap. For this reason, it is always wise to make positive identification of the station being tuned, by switching the function selector to ANT and listening for station call letters.

ELECTRICAL STORMS:

In the vicinity of electrical storms, an ADF indicator pointer tends to swing from the station tuned toward the center of the storm.

NIGHT EFFECT:

This is a disturbance particularly strong just after sunset and just after dawn. An ADF indicator pointer may swing erratically at these times. If possible, tune to the most powerful station at the lowest frequency. If this is not possible, take the average of pointer oscillations to determine relative station bearing.

MOUNTAIN EFFECT:

Radio waves reflecting from the surface of mountains may cause the pointer to fluctuate or show an erroneous bearing. This should be taken into account when taking bearings over mountainous ter

COASTAL REFRACTION:

Radio waves may be refracted when passing from land to sea or when moving parallel to the coastline. This also should be taken into account.

SECTION 9 - SUPPLEMENTS
SUPPLEMENT 6 - FAA APPROVED

CESSNA
MODEL 172R

SECTION 5 PERFORMANCE

There is no change to the airplane performance when this avionic equipment is installed. However, the installation of an externally mounted antenna or related external antennas, will result in a minor reduction in cruise performance.



**Pilot's Operating Handbook and
FAA Approved Airplane Flight Manual**

**CESSNA MODEL 172R
AIRPLANES 172R80001 AND ON**

SUPPLEMENT 7

**BENDIX/KING KAP 140
SINGLE AXIS AUTOPILOT**

| |
|------------------------|
| SERIAL NO. _____ |
| REGISTRATION NO. _____ |

This supplement must be inserted into Section 9 of the Pilot's Operating Handbook and FAA Approved Airplane Flight Manual when the KAP 140 Single Axis Autopilot is installed.

| |
|--|
| FAA APPROVAL FAA APPROVED UNDER FAR 21 SUBPART J The Cessna Aircraft Co Delegation Option Manufacturer CE-1 <i>Richard W. Walby</i> Executive Engineer Date: 3 April 2000 |
|--|

 Member of GAMA

2 DECEMBER 1996

Revision 4 - 31 October 2002

COPYRIGHT © 1996
CESSNA AIRCRAFT COMPANY
WICHITA, KANSAS, USA

172RPI113-57-01

S7-1

SUPPLEMENT 7

BENDIX/KING KAP 140 SINGLE AXIS AUTOPILOT

Use the Log of Effective Pages to determine the current status of this supplement. Pages affected by the current revision are indicated by an asterisk (*) preceding the page number.

| Supplement Status | Date |
|-------------------|------------------|
| Original Issue | 2 December 1996 |
| Revision 1 | 28 February 1997 |
| Revision 2 | 3 November 1997 |
| Revision 3 | 28 February 2000 |
| Revision 4 | 31 October 2002 |

LOG OF EFFECTIVE PAGES

| Page | Page Status | Revision Number |
|-------------------|-------------|-----------------|
| * Title (S7-1) | Revised | 4 |
| * S7-1 thru S7-5 | Revised | 4 |
| S7-6 thru S7-7 | Revised | 3 |
| * S7-8 thru S7-19 | Revised | 4 |
| * S7-20 | Added | 4 |

APPROVED BY

FAA APPROVED UNDER FAR 23 SUBPART J
The Cessna Aircraft Co.
Religation Option Authorization DOA-10028-02
Richard W. Hickey Executive Engineer

DATE OF APPROVAL 10-31-02

CESSNA
MODEL 172R

SECTION 9 - SUPPLEMENTS
SUPPLEMENT 7 - FAA APPROVED

SUPPLEMENT 7
BENDIX/KING KAP 140
SINGLE AXIS AUTOPILOT

SERVICE BULLETIN CONFIGURATION LIST

The following is a list of Service Bulletins that are applicable to the operation of the airplane, and have been incorporated into this supplement. This list contains only those Service Bulletins that are currently active.

| <u>Number</u> | <u>Title</u> | <u>Airplane Serial Effectivity</u> | <u>Revision Incorporation</u> | <u>Incorporated In Airplane</u> |
|--|--------------|--|-----------------------------------|-------------------------------------|
| KC-140-M1 (Honeywell Service Bulletin) | KAP 140 AP | | Revision 4 | |

.....

.....

.....

.....

.....

.....

.....

.....

.....

.....

.....

.....

SUPPLEMENT 7

BENDIX/KING KAP 140 SINGLE AXIS AUTOPILOT

SECTION 1

GENERAL

The Bendix/King KAP 140 is an all-electric, single-axis (aileron control) autopilot system that provides lateral and directional control. Components are a computer, a turn coordinator, an aileron actuator, a course deviation indicator, and a directional indicator or HSI (if installed).

Roll and yaw motions of the airplane are sensed by the turn coordinator gyro. The computer computes the necessary correction and signals the actuator to move the ailerons to maintain the airplane in the commanded lateral attitude.

The KAP 140 will provide wing leveler, heading hold, NAV track, and approach and backcourse lateral modes.

A lockout device prevents autopilot engagement until the system has been successfully preflight tested. Automatic preflight self-test begins with initial power application to the autopilot.

The following conditions will cause the autopilot to disengage:

- A. Electric power failure.
- B. Internal autopilot system failure.
- C. Turn coordinator failure (flagged gyro).
- D. Computer autopilot monitor that detects the R (ROLL) axis annunciator.

The AVIONICS MASTER switch supplies power to the avionics bus bar at the radio circuit breakers and the autopilot circuit breaker. The AVIONICS MASTER switch also services as an emergency autopilot (AP) shutoff.

The following circuit breakers are used to protect the listed elements of the KAP 140 single axis autopilot:

| <u>LABEL</u> | <u>FUNCTIONS</u> |
|---------------|---|
| AUTO PILOT | Supplies power to the KC 140 Computer and the autopilot. |
| WARN | Supplies power to the autopilot disconnect tone. |

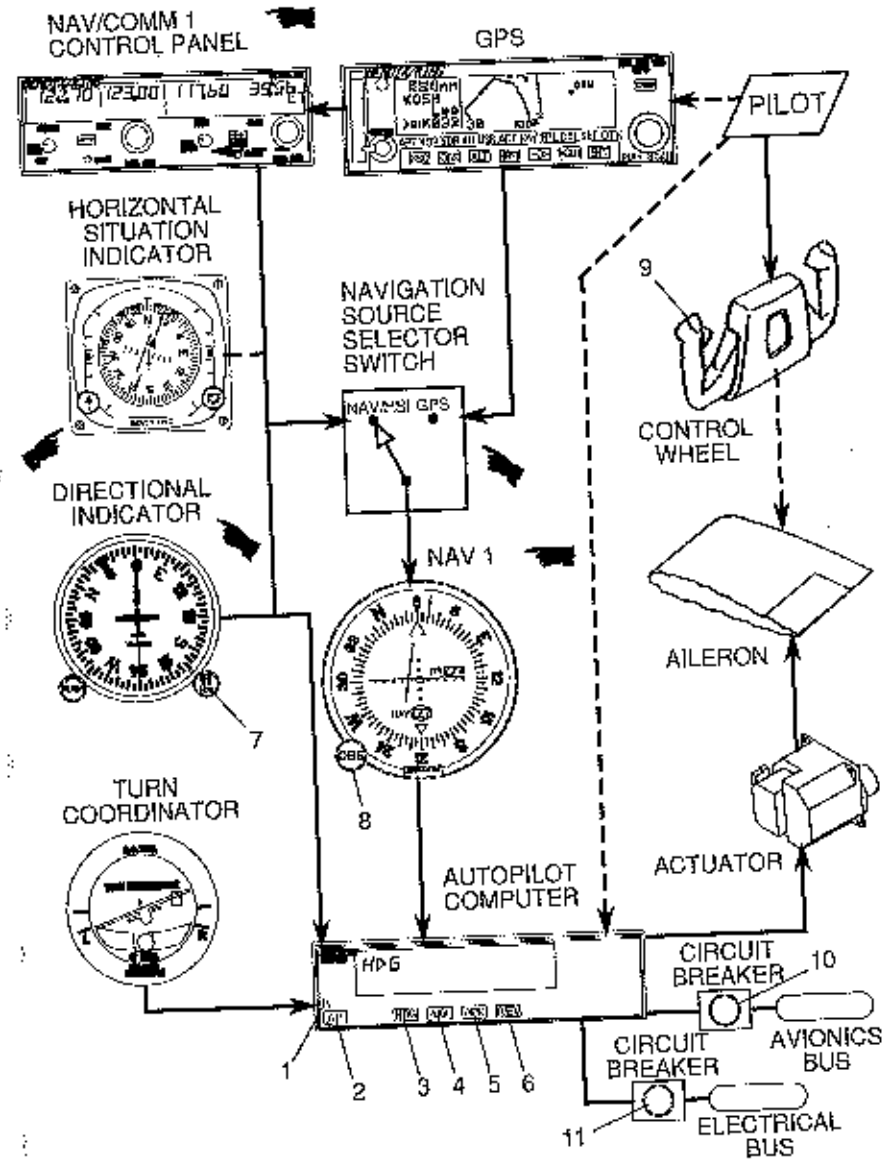
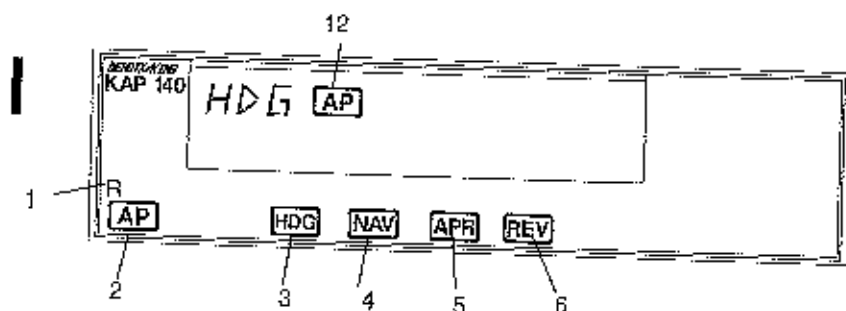

Figure 1. Bendix/King KAP 140 Autopilot, Operating Controls and Indicators (Sheet 1 of 3)



1. ROLL (R) AXIS ANNUNCIATOR -- When illuminated, indicates a failure in the roll axis and prevents engagement or disengages the autopilot.

2. AUTOPILOT ENGAGE/DISENGAGE (AP) BUTTON -- When pushed* or pressed and held (approx 0.25 seconds)**, engages autopilot if all preflight self test conditions are met. The autopilot will engage in the basic ROL mode which functions as a wings leveler. The AP button can also be used to disengage the autopilot.

3. HEADING (HDG) MODE SELECTOR BUTTON -- When pushed, will select the Heading mode, which commands the airplane to turn to and maintain the heading selected by the heading bug on the Directional Gyro or HSI (if installed). A new heading may be selected at any time and will result in the airplane turning to the new heading. The button can also be used to toggle between HDG and ROL modes. This button can also be used to engage the autopilot in HDG mode. For airplane serials 17280001 thru 17281118 not incorporating Honeywell Service Bulletin KC140-M1, this button will also engage the autopilot in HDG mode.

* Airplane serials 17280001 thru 17281118 not incorporating Honeywell Service Bulletin KC140-M1.

** Airplane serials 17280001 thru 17281118 incorporating Honeywell Service Bulletin KC140-M1, and airplane serials 17281119 and on.

Figure 1. Bendix/King KAP 140 Autopilot, Operating Controls and Indicators (Sheet 2 of 3)

4. NAVIGATION (NAV) MODE SELECTOR BUTTON -- When pushed, will select the Navigation mode. This mode provides automatic beam capture and tracking of VOR, LOC, or GPS signals as selected for presentation on the NAV#1 CDI or HSI (if installed).
5. APPROACH (APR) MODE SELECTOR BUTTON -- When pushed, will select the Approach mode. This mode provides automatic beam capture and tracking of VOR, LOC, or GPS signals as selected for presentation on the NAV #1 CDI or HSI (if installed). The greater tracking sensitivity of the APR mode is recommended for instrument approaches.
6. BACK COURSE APPROACH (REV) MODE SELECTOR BUTTON -- This button is active only when the coupled navigation receiver is tuned to a LOC/ILS frequency. When pushed, it will select the Back Course (BC) approach mode. This mode functions identically to the approach mode except that the autopilot response to LOC signals is reversed.
7. HEADING SELECT KNOB (HDG) -- Positions the heading pointer ("bug") on the compass card. Note that the position of the heading bug also provides course datum to the autopilot when tracking in NAV, APR, or REV (BC) modes. This is in addition to its more intuitive use in the HDG mode.
8. OMNI BEARING SELECT KNOB (OBS) -- Selects the desired course radial to be tracked by the autopilot. (Note that the HDG bug must also be positioned to the proper course to capture and track the selected radial).
9. AUTOPILOT DISCONNECT (A/P DISC) SWITCH -- When depressed will disengage the autopilot. The autopilot disconnect will be annunciated by a continuous two-second tone accompanied by a flashing "AP" displayed on the autopilot computer.
10. AUTOPILOT CIRCUIT BREAKER -- A 5-amp circuit breaker supplying 28 VDC to the KAP 140 system.

Figure 1. Bendix/King KAP 140 Autopilot, Operating Controls and Indicators (Sheet 3 of 3)

11. WARN C/B -- Power to the autopilot disconnect horn.

12. AUTOPILOT ENGAGE [AP] Annunciation** -- Illuminates whenever the autopilot is engaged. Flashes during pilot initiated or automatic disengagement.

* Airplane serials 17280001 thru 17281118 not incorporating Honeywell Service Bulletin KC140-M1.

** Airplane serials 17280001 thru 17281118 incorporating Honeywell Service Bulletin KC140-M1, and airplane serials 17281119 and on.

SECTION 2 LIMITATIONS

The following autopilot limitations must be adhered to:

1. The autopilot must be OFF during takeoff and landing.
2. During autopilot operation, the pilot, with seat belt fastened, must be seated in the left front seat.
3. Continued autopilot system use is prohibited following abnormal or malfunctioning operation, and prior to corrective maintenance.
4. The entire PREFLIGHT procedure, outlined under Section 4, including steps 1 through 6, must be successfully completed prior to each flight. Use of the autopilot is prohibited prior to completion of these tests.
5. KMA 28 audio amplifier PUSH OFF/EMG operation is prohibited during normal operations.

NOTE

During emergency operation of the audio amplifier, the PUSH OFF/EMG state of the KMA 28 will prevent flight control system alerts from being heard.

SECTION 3 EMERGENCY PROCEDURES

The two step procedure listed under paragraph 1 should be among the basic airplane emergency procedures that are committed to memory. It is important that the pilot be proficient in accomplishing both steps without reference to this manual.

1. In case of Autopilot malfunction (accomplish items a. and b. simultaneously):
 - a. Airplane Control Wheel -- GRASP FIRMLY and regain aircraft control.
 - b. A/P DISC Switch -- PRESS and HOLD throughout recovery.

NOTE

The AVIONICS MASTER switch may be used as an alternate means of removing power from the autopilot. In addition to the above, power may be removed with the Engage/Disengage button or the airplane MASTER switch. If necessary perform steps a. and b. above, then turn off the AVIONICS MASTER switch. Primary attitude, airspeed, directional and altitude control instruments will remain operational with either master switch OFF.

WARNING

- DO NOT ATTEMPT TO RE-ENGAGE THE AUTOPILOT FOLLOWING AN AUTOPILOT MALFUNCTION.
- THE PILOT IN COMMAND MUST CONTINUOUSLY MONITOR THE AUTOPILOT WHEN IT IS ENGAGED, AND BE PREPARED TO DISCONNECT THE AUTOPILOT AND TAKE IMMEDIATE CORRECTIVE ACTION - INCLUDING MANUAL CONTROL OF THE AIRPLANE AND/OR PERFORMANCE OF EMERGENCY PROCEDURES - IF AUTOPILOT OPERATION IS NOT AS EXPECTED OR IF AIRPLANE CONTROL IS NOT MAINTAINED.

AMPLIFIED EMERGENCY PROCEDURES

The following paragraphs are presented to supply additional information for the purpose of providing the pilot with a more complete understanding of the recommended course of action for an emergency situation.

⚠ WARNING

DO NOT ATTEMPT TO RE-ENGAGE THE AUTOPILOT FOLLOWING AN AUTOPILOT MALFUNCTION UNTIL CORRECTIVE SERVICE ACTION HAS BEEN PERFORMED ON THE SYSTEM.

An autopilot malfunction occurs when there is an uncommanded deviation in the airplane flight path or when there is abnormal control wheel movement. The main concern in reacting to an autopilot malfunction, or to an automatic disconnect of the autopilot, is in maintaining control of the airplane. Immediately grasp the control wheel and press and hold down the A/P DISC switch throughout the recovery. Manipulate the controls as required to safely maintain operation of the airplane within all of its operating limitations. The AVIONICS MASTER switch may be used as required to remove all power from the Autopilot. With the AVIONICS MASTER switch off, all flight instruments will remain operational; however, communications, navigation, and identification equipment will be inoperative.

Note that the emergency procedure for any malfunction is essentially the same: immediately grasp the control wheel and regain airplane control while pressing and the holding the A/P DISC switch down.

It is important that all portions of the autopilot system are preflight tested prior to each flight in accordance with the procedures published herein in order to assure their integrity and continued safe operation during flight.

A flashing mode annunciation on the face of the autopilot is normally an indication of mode loss.

NOTE

An exception to this is HDG annunciation which will flash for 5 seconds along with steady NAVARM, APRARM, or REVARM annunciation to remind the pilot to set the HDG bug for course datum use.

1. Flashing HDG -- Indicates a failed heading. PRESS HDG button to terminate flashing. ROL will be displayed.
2. Flashing NAV, APR or REV -- Indicates a flagged navigation source. If no NAV source is flagged, a failed heading mode can be the cause. PRESS NAV, APR or REV button to terminate flashing. ROL will be displayed.

NOTE

At the onset of mode annunciator flashing, the autopilot has already reverted to a default mode of operation, (i.e., ROL mode). An immediate attempt to reengage the lost mode may be made if the offending navigation flag has cleared.

Effects of Instrument losses upon autopilot operation:

1. Loss of the artificial horizon -- no effect on the autopilot.
2. Loss of the turn coordinator -- autopilot inoperative.
3. Loss of the Directional Gyro (DG) -- The directional gyro does not provide any system valid flag. If the DG fails to function properly the autopilot heading and navigation mode will not function correctly. Under these conditions, the only useable lateral mode is ROL.
4. Loss of Horizontal Situation Indicator (HSI) (if installed) -- If the HSI fails to function properly the autopilot heading and navigation mode will not function correctly. Under these conditions, the only usable lateral mode is ROL.

SECTION 4 NORMAL PROCEDURES

PREFLIGHT (PERFORM PRIOR TO EACH FLIGHT):

1. GYROS -- Allow time for the turn coordinator to come up to speed, as evidenced by the turn coordinator flag being pulled from view.
2. AVIONICS MASTER -- ON.
3. POWER APPLICATION AND SELF TEST
A self test is performed upon power application to the computer. This test is a sequence of internal checks that validate proper system operation prior to allowing normal system operation. The sequence is indicated by "PFT" (pre-flight test) with an increasing number for the sequence steps. Successful completion of self test is identified by all display segments being illuminated (Display Test) and the disconnect tone sounding.
4. AUTOPILOT -- ENGAGE by pressing AP button.
5. FLIGHT CONTROLS -- MOVE left and right to verify that the autopilot can be overpowered.

NOTE

Normal use will not require the autopilot to be overpowered.

6. A/P DISC Switch -- PRESS. Verify that the autopilot disconnects and tone sounds.

BEFORE TAKEOFF:

1. Autopilot -- OFF.

AUTOPILOT ENGAGEMENT:

1. AP Button -- PRESS. Note ROL annunciator on. If no other modes are selected the autopilot will operate in the ROL mode.

NOTE

Aircraft heading may change in ROL mode due to turbulence.

AUTOPILOT ENGAGEMENT:

1. AP Button -- PRESS. Note ROL annunciator on. If no other modes are selected the autopilot will operate in the ROL mode.

NOTE

Aircraft heading may change in ROL mode due to turbulence.

HEADING HOLD

1. Heading Selector Knob -- SET bug to desired heading.
2. HDG Mode Selector Button -- PRESS. Note HDG mode annunciator ON. Autopilot will automatically turn the aircraft to the selected heading.

COMMAND TURNS (HEADING HOLD MODE ENGAGED)

1. Heading Selector Knob -- MOVE bug to the desired heading. Autopilot will automatically turn the aircraft to the new selected heading.

NAV COUPLING

1. When equipped with DG:
 - a. NAV#1 OBS Knob -- **SELECT** desired course.
 - b. NAV Mode Selector Button -- **PRESS**. Note NAVARM annunciated.
 - c. Heading Selector Knob -- **ROTATE BUG** to agree with OBS course.

NOTE

When NAV is selected, the autopilot will flash HDG for 5 seconds to remind the pilot to reset the HDG bug to the OBS course. If HDG mode was in use at the time of NAV button selection, a 45° intercept angle will then be automatically established based on the position of the bug.

NOTE

All angle intercepts compatible with radar vectors may be accomplished by selecting ROL mode **PRIOR** to pressing the NAV button. The HDG bug must still be positioned to agree with the OBS course to provide course datum to the autopilot when using a DG (Directional Gyro).

- 1) If the CDI needle is greater than 2 to 3 dots from center, the autopilot will annunciate **NAVARM**. When the computed capture point is reached, the **ARM** annunciator will go out and the selected course will be automatically captured and tracked.
 - 2) If the CDI needle is less than 2 to 3 dots from center, the HDG mode will disengage upon selecting NAV mode. The **NAV** annunciator will then illuminate and the capture/track sequence will automatically begin.
2. When equipped with HSI:
- a. Course Bearing Pointer - **SET** to desired course.
 - b. Heading Selector Knob -- **SET BUG** to provide desired intercept angle and engage HDG mode.
 - c. **NAV** Mode Selector Button -- **PRESS**.
- 1) If the Course Deviation Bar (D-Bar) is greater than 2 to 3 dots from center, the autopilot will annunciate **NAVARM**. When the computed capture point is reached the **ARM** annunciator will go out and the selected course will be automatically captured and tracked.
 - 2) If the D-Bar is less than 2 to 3 dots from center, the HDG mode will disengage upon selecting NAV mode; the **NAV** annunciator will illuminate and the capture/track sequence will automatically begin.

APPROACH (APR) COUPLING: (To enable glideslope coupling on an ILS and more precise tracking on instrument approaches).

1. When equipped with DG:
 - a. **NAV #1 OBS** Knob -- **SELECT** desired approach course. (For a localizer, set it to serve as a memory aid.)
 - b. **APR** Mode Selector Button -- **PRESS**. Note **APR_{ARM}** annunciated.
 - c. Heading Selector Knob -- **ROTATE BUG** to agree with desired approach.

NOTE

When APR is selected, the autopilot will flash HDG for 5 seconds to remind the pilot to reset the HDG bug to the approach course. If HDG mode was in use at the time of APR button selection a 45° intercept angle will then be automatically established based on the position of the bug.

NOTE

All angle intercepts compatible with radar vectors may be accomplished by selecting ROL mode **PRIOR** to pressing the APR button. The HDG bug must still be positioned to agree with the desired approach course to provide course datum to the autopilot when using a DG.

- 1) If the CDI needle is greater than 2 to 3 dots from center, the autopilot will annunciate **APR_{ARM}**; when the computed capture point is reached the **ARM** annunciator will go out and the selected course will be automatically captured and tracked.

- 2) If the CDI needle is less than 2 to 3 dots from center, the HDG mode will disengage upon selecting APR mode; the **APR** annunciator will illuminate and the capture/track sequence will automatically begin.
2. When equipped with HSI:
- a. Course Bearing Pointer -- **SET** to desired course.
 - b. Heading Selector Knob -- **SET BUG** to provide desired intercept angle.
 - c. **APR** Mode Selector Button -- **PRESS**.
- 1) If the D-Bar is greater than 2 to 3 dots from center, the autopilot will annunciate **APR ARM**; when the computed capture point is reached the **ARM** annunciator will go out and the selected course will be automatically captured and tracked.
 - 2) If the D-Bar is less than 2 to 3 dots from center, the HDG mode will disengage upon selecting APR mode; the **APR** annunciator will illuminate and the capture/track sequence will automatically begin.
- d. Airspeed -- **MAINTAIN** 90 KIAS during autopilot approaches (recommended).

BACK COURSE (REV) APPROACH COUPLING (i.e., reverse localizer):

1. When equipped with DG:
- a. **NAV #1 OBS** Knob -- **SELECT** the localizer course to the front course inbound (as a memory aid).
 - b. **REV** Mode Selector Button -- **PRESS**.
 - c. Heading Selector Knob -- **ROTATE BUG** to the heading corresponding to the localizer front course bound.

NOTE

- When REV is selected, the autopilot will flash HDG for 5 seconds to remind the pilot to reset the HDG bug to the localizer FRONT COURSE INBOUND heading. If heading mode was in use at the time of REV button selection, a 45° intercept angle will then be automatically established based on the position of the bug.
 - All angle intercepts compatible with radar vectors may be accomplished by selecting ROL mode PRIOR to pressing the REV button. The HDG bug must still be positioned to the localizer FRONT COURSE INBOUND heading to provide course datum to the autopilot when using a DG.
- 1) If the CDI needle is greater than 2 to 3 dots from center, the autopilot will annunciate **REV ARM**; when the computed capture point is reached the ARM annunciator will go out and the selected back course will be automatically captured and tracked.
 - 2) If the CDI needle is less than 2 to 3 dots from center, the HDG mode will disengage upon selecting REV mode; the REV annunciator will illuminate and the capture/track sequence will automatically begin.
2. When equipped with HSI:
- a. Course Bearing Pointer -- **SET** to the ILS front course inbound heading.
 - b. Heading Selector Knob -- **SET BUG** to provide desired intercept angle and engage HDG mode.
 - c. **REV Mode Selector Button -- PRESS.**
 - 1) If the D-Bar is greater than 2 to 3 dots from center, the autopilot will annunciate **REV ARM**; when the computed capture point is reached the **ARM** annunciator will go out and the selected back course will be automatically captured and tracked.

- 2) If the D-Bar is less than 2 to 3 dots from center, the HDG mode will disengage upon selecting **REV** mode; the **REV** annunciator will illuminate and the capture/track sequence will automatically begin.
- d. Airspeed -- **MAINTAIN** 90 KIAS during autopilot approaches (recommended).

MISSED APPROACH

1. A/P DISC -- PRESS to disengage AP.
2. MISSED APPROACH -- EXECUTE.
3. AP Button -- PRESS (if AP operation is desired). Note ROL annunciator ON. Select optional lateral modes as desired.

BEFORE LANDING

1. A/P DISC Switch -- PRESS to disengage AP.

SECTION 5 PERFORMANCE

There is no change to the airplane performance when the KAP140 Autopilot is installed.



**Pilot's Operating Handbook and
FAA Approved Airplane Flight Manual**

**CESSNA MODEL 172R
AIRPLANES 80001 AND ON
SUPPLEMENT 8
WINTERIZATION KIT**

| |
|------------------------|
| SERIAL NO. _____ |
| REGISTRATION NO. _____ |

This supplement must be inserted into Section 9 of the Pilot's Operating Handbook and FAA Approved Airplane Flight Manual when the winterization kit is installed.

| |
|---|
| FAA APPROVAL FAA APPROVED UNDER FAR 21 SUBPART J The Cessna Aircraft Co Delegation Option Manufacturer CE-1 <i>Richard W. Holby</i> Executive Engineer Date: February 28, 1997 |
|---|

 Member of GAMA
28 FEBRUARY 1997

COPYRIGHT © 1997
CESSNA AIRCRAFT COMPANY
WICHITA, KANSAS, USA

S8-1

172RPHUS-S8-00

SUPPLEMENT 8

WINTERIZATION KIT

The following Log of Effective Pages provides the date of issue for original and revised pages, as well as a listing of all pages in the Supplement. Pages which are affected by the current revision will carry the date of that revision.

| <u>Revision Level</u> | <u>Date of Issue</u> |
|-----------------------|----------------------|
| 0 (Original) | Feb 28, 1997 |

LOG OF EFFECTIVITY

| PAGE | DATE | PAGE | DATE |
|--------------|-----------|------|------|
| Title (S8-1) | Feb 28/97 | | |
| S8-2 | Feb 28/97 | | |
| S8-3 | Feb 28/97 | | |
| S8-4 | Feb 28/97 | | |

SERVICE BULLETIN CONFIGURATION LIST

The following is a list of Service Bulletins that are applicable to the operation of the airplane, and have been incorporated into this supplement. This list contains only those Service Bulletins that are currently active.

| <u>Number</u> | <u>Title</u> | <u>Airplane Unit Effectivity</u> | <u>Revision Incorporation</u> | <u>Incorporated In Airplane</u> |
|---------------|--------------|----------------------------------|-------------------------------|---------------------------------|
|---------------|--------------|----------------------------------|-------------------------------|---------------------------------|

SUPPLEMENT

WINTERIZATION KIT

SECTION 1 GENERAL

The winterization kit consists of two cover plates (with placards) which attach to the air intakes in the cowling nose cap, a placard silk screened on the instrument panel, and insulation for the crankcase breather line. This equipment should be installed for operations in temperatures consistently below 20°F (-7°C). Once installed, the crankcase breather insulation is approved for permanent use, regardless of temperature.

SECTION 2 LIMITATIONS

The following information must be presented in the form of placards when the airplane is equipped with a winterization kit.

1. On each nose cap cover plate:

REMOVE WHEN O.A.T. EXCEEDS +20°F.

2. On the instrument panel near the EGT gauge:

WINTERIZATION KIT MUST BE REMOVED WHEN OUTSIDE
AIR TEMPERATURE IS ABOVE 20°F.

**SECTION 3
EMERGENCY PROCEDURES**

There is no change to the airplane emergency procedures when the winterization kit is installed.

**SECTION 4
NORMAL PROCEDURES**

There is no change to the airplane normal procedures when the winterization kit is installed.

**SECTION 5
PERFORMANCE**

There is no change to the airplane performance when the winterization kit is installed.



**Pilot's Operating Handbook and
FAA Approved Airplane Flight Manual**

**CESSNA MODEL 172R
AIRPLANES 17280001 AND ON
SUPPLEMENT 9
DAVTRON MODEL 803
CLOCK/O.A.T.**

| |
|------------------------|
| SERIAL NO. _____ |
| REGISTRATION NO. _____ |

This supplement must be inserted into Section 9 of the Pilot's Operating Handbook and FAA Approved Airplane Flight Manual when the Davtron Clock/O.A.T. is installed.

| |
|--|
| FAA APPROVAL FAA APPROVED UNDER FAR 21 SUBPART J The Cessna Aircraft Co Delegation Option Manufacturer CE-1 <i>Richard W. Nelson</i> Executive Engineer Date: March 4, 1998 |
|--|

 Member of GAMA

28 FEBRUARY 1997

Revision 1 - 3 November 1997

COPYRIGHT © 1997
CESSNA AIRCRAFT COMPANY
WICHITA, KANSAS, USA

172RPHUS-S9-01

S9-1

SUPPLEMENT 9

DAVTRON MODEL 803 CLOCK/O.A.T.

The following Log of Effective Pages provides the date of issue for original and revised pages, as well as a listing of all pages in the Supplement. Pages which are affected by the current revision will carry the date of that revision.

| <u>Revision Level</u> | <u>Date of Issue</u> |
|-----------------------|----------------------|
| 0 (Original) | Feb 28, 1997 |
| 1 | Nov. 3, 1997 |

LOG OF EFFECTIVITY

| <u>PAGE</u> | <u>DATE</u> | <u>PAGE</u> | <u>DATE</u> |
|--------------|-------------|-------------|-------------|
| Title (S9-1) | Nov 3/97 | S9-5 | Feb 28/97 |
| S9-2 | Nov 3/97 | S9-6 | Feb 28/97 |
| S9-3 | Feb 28/97 | | |
| S9-4 | Feb 28/97 | | |

SERVICE BULLETIN CONFIGURATION LIST

The following is a list of Service Bulletins that are applicable to the operation of the airplane, and have been incorporated into this supplement. This list contains only those Service Bulletins that are currently active.

| <u>Number</u> | <u>Title</u> | <u>Airplane Unit Effectivity</u> | <u>Revision Incorporation</u> | <u>Incorporated in Airplane</u> |
|---------------|--------------|--|-----------------------------------|-------------------------------------|
|---------------|--------------|--|-----------------------------------|-------------------------------------|

SUPPLEMENT

DIGITAL CLOCK/O.A.T.

SECTION 1 GENERAL

The Davtron Model 803 digital clock combines the features of a clock, outside air temperature gauge (O.A.T.) and voltmeter in a single unit. The unit is designed for ease of operation with the use of three buttons. The upper button is used to control sequencing between temperature and voltage. The lower two buttons control reading and timing functions related to the digital clock. Temperature and voltage functions are displayed in the upper portion of the unit's LCD window, and clock/timing functions are displayed in the lower portion of the unit's LCD window.

The digital display features an internal light (back light) to ensure good visibility under low cabin lighting conditions and at night. The intensity of the back light is controlled by the PANEL LT rheostat. In addition, the display incorporates a test function which allows checking that all elements of the display are operating.

SECTION 2 LIMITATIONS

There is no change to the airplane limitations when the digital clock/O.A.T. is installed.

SECTION 3 EMERGENCY PROCEDURES

There is no change to the airplane emergency procedures when the digital clock/O.A.T. is installed.

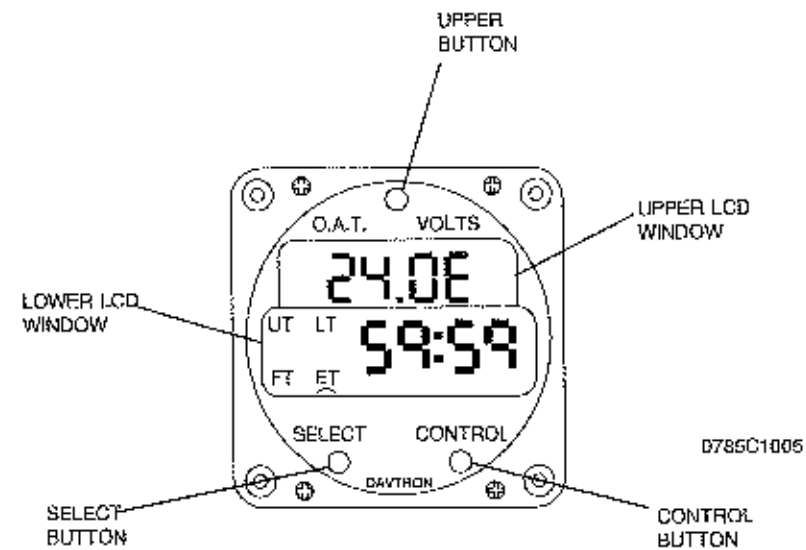

Figure 1. Clock/OAT Gauge

SECTION 4 NORMAL PROCEDURES

TEST MODE

The unit may be tested by holding the SELECT button down for three seconds. Proper operation is indicated by the display 88:88 and activation of all four annunciators.

O.A.T. / VOLTMETER OPERATION

The upper portion of the LCD window is dedicated to O.A.T. and voltmeter operations. The voltmeter reading is preselected upon startup and is indicated by an "E" following the display reading. Pushing the upper control button will sequence the window from voltage to fahrenheit ("F") to centigrade ("C"), and back again to voltage.

CLOCK OPERATIONS

The lower portion of the LCD window is dedicated to clock and timing operations. Pushing the SELECT button will sequence the window from universal time (UT) to local time (LT) to flight time (FT) to elapsed time (ET), and back again to universal time. Pushing the CONTROL button allows for timing functions within the four SELECT menus. Setting procedures are as follows:

SETTING UNIVERSAL TIME

Use the SELECT button to select universal time (UT). Simultaneously press both the SELECT and the CONTROL buttons to enter the set mode. The tens of hours digit will start flashing. The CONTROL button has full control of the flashing digit, and each button push increments the digit. Once the tens of hours is set the SELECT button selects the next digit to be set. After the last digit has been selected and set with the CONTROL button, a final push of the SELECT button exits the set mode. The lighted annunciator will resume its normal flashing, indicating the clock is running in universal time mode.

SETTING LOCAL TIME

Use the SELECT button to select local time (LT). Simultaneously press both the SELECT and the CONTROL buttons to enter the set mode. The tens of hours digit will start flashing. The set operation is the same as for UT, except that minutes are already synchronized with the UT clock and cannot be set in local time.

FLIGHT TIME RESET

Use the SELECT button to select flight time (FT). Hold the CONTROL button down for 3 seconds, or until 99:59 appears on the display. Flight time will be zeroed upon release of the CONTROL button.

SETTING FLIGHT TIME FLASHING ALARM

Use the SELECT button to select flight time (FT). Simultaneously press both the SELECT and the CONTROL buttons to enter the set mode. The tens of hours digit will start flashing. The set operation is the same as for UT. When actual flight time equals the alarm time, the display will flash. Pressing either the SELECT or CONTROL button will turn the flashing off and zero the alarm time. Flight time is unchanged and continues counting.

SETTING ELAPSED TIME COUNT UP

Use the SELECT button to select elapsed time (ET). Press the CONTROL button and elapsed time will start counting. Elapsed time counts up to 59 minutes, 59 seconds, and then switches to hours and minutes. It continues counting up to 99 hours and 59 minutes. Pressing the CONTROL button again resets elapsed time to zero.

SETTING ELAPSED TIME COUNT DOWN

Use the SELECT button to select Elapsed Time (ET). Simultaneously press both the SELECT and the CONTROL buttons to enter the set mode. The tens of hours digit will start flashing. The set operation is the same as for UT, and a count down time can be set from a maximum of 59 minutes and 59 seconds. Once the last digit is set, pressing the SELECT button exits the set mode and the clock is ready to start the countdown. Pressing the CONTROL button now will start the countdown. When countdown reaches zero, the display will flash. Pressing either the SELECT or CONTROL button will reset the alarm. After reaching zero, the elapsed time counter will count up.

Button Select Disable

When there is no airplane power applied to the unit, the CONTROL and SELECT buttons are disabled.

SECTION 5 PERFORMANCE

There is no change to the airplane performance when this equipment is installed. However, installation of this O.A.T. probe will result in a minor reduction in cruise performance.



**Pilot's Operating Handbook and
FAA Approved Airplane Flight Manual**

**CESSNA MODEL 172R
AIRPLANES 80001 AND ON
SUPPLEMENT 12
CANADIAN
SUPPLEMENT**

| |
|------------------------|
| SERIAL NO. _____ |
| REGISTRATION NO. _____ |

This supplement must be inserted into Section 9 of the Pilot's Operating Handbook and FAA Approved Airplane Flight Manual when used for Canadian Operation.



 Member of GAMA
28 FEBRUARY 1997

COPYRIGHT © 1997
CESSNA AIRCRAFT COMPANY
WICHITA, KANSAS, USA

172RPHUS-S12-00

S12-1

SUPPLEMENT 12

CANADIAN SUPPLEMENT

The following Log of Effective Pages provides the date of issue for original and revised pages, as well as a listing of all pages in the Supplement. Pages which are affected by the current revision will carry the date of that revision

| <u>Revision Level</u> | <u>Date of Issue</u> |
|-----------------------|----------------------|
| 0 (Original) | Feb 28, 1997 |

LOG OF EFFECTIVITY

| <u>PAGE</u> | <u>DATE</u> | <u>PAGE</u> | <u>DATE</u> |
|---------------|-------------|-------------|-------------|
| Title (S12-1) | Feb 28/97 | S12-3 | Feb 28/97 |
| S12-2 | Feb 28/97 | S12-4 | Feb 28/97 |

SERVICE BULLETIN CONFIGURATION LIST

The following is a list of Service Bulletins that are applicable to the operation of the airplane, and have been incorporated into this supplement. This list contains only those Service Bulletins that are currently active.

| <u>Number</u> | <u>Title</u> | <u>Airplane Unit Effectivity</u> | <u>Revision Incorporation</u> | <u>Incorporated In Airplane</u> |
|---------------|--------------|--|-----------------------------------|-------------------------------------|
|---------------|--------------|--|-----------------------------------|-------------------------------------|

CESSNA
MODEL 172R

SECTION 9 - SUPPLEMENTS
SUPPLEMENT 12 - FAA APPROVED

SUPPLEMENT 12

CANADIAN SUPPLEMENT

SECTION 1

GENERAL

This supplement is required for Canadian operation of Cessna Model 172R.

SECTION 2

LIMITATIONS

The following placard must be installed.

1. Near the fuel tank filler cap:

FUEL
100LL/ 100 MIN. GRADE AVIATION GASOLINE
CAP. 26.5 U.S. GAL. (100 LITRES) USABLE
CAP 17.5 U.S. GAL. (66 LITRES) USABLE
TO BOTTOM OF FILLER INDICATOR TAB

SECTION 9 - SUPPLEMENTS
SUPPLEMENT 12 - FAA APPROVED

CESSNA
MODEL 172R

**SECTION 3
EMERGENCY PROCEDURES**

There is no change to the airplane emergency procedures when used for Canadian operation.

**SECTION 4
NORMAL PROCEDURES**

There is no change to basic airplane normal operating procedures when used for Canadian operation.

**SECTION 5
PERFORMANCE**

There is no change to the airplane performance when used for Canadian operation.



**Pilot's Operating Handbook and
FAA Approved Airplane Flight Manual**

**CESSNA MODEL 172R
AIRPLANES 17280831 AND ON**

**SUPPLEMENT 15
BENDIX/KING KAP 140
2 AXIS AUTOPILOT**

| |
|------------------------|
| SERIAL NO. _____ |
| REGISTRATION NO. _____ |

This supplement must be inserted into Section 9 of the Pilot's Operating Handbook and FAA Approved Airplane Flight Manual when the KAP 140 2 Axis Autopilot System is installed.

| |
|---|
| FAA APPROVAL FAA APPROVED UNDER PART 21 SUBPART J The Cessna Aircraft Co. Delegation Option Authorization DCA-160128-02 <i>Richard W. Hickey</i> Executive Engineer Date: January 9, 2001 |
|---|

 Member of GAMA

30 December 2000

Revision 2 - 31 October 2002

COPYRIGHT © 2000
CESSNA AIRCRAFT COMPANY
WICHITA, KANSAS, USA

172RPHUS-S15-02

S15-1

SUPPLEMENT 15

BENDIX/KING KAP 140 2 AXIS AUTOPILOT

Use the Log of Effective Pages to determine the current status of this supplement. Pages affected by the current revision are indicated by an asterisk (*) preceding the page number.

| Supplement Status | Date |
|-------------------|-----------------|
| Original Issue | 1 December 1997 |
| Revision 1 | 28 June 2002 |
| Revision 2 | 31 October 2002 |

LOG OF EFFECTIVE PAGES

| Page | Page Status | Revision Number |
|---------------------|----------------|-----------------|
| * Title (S15-1) | Revised | 2 |
| * S15-2 | Revised | 2 |
| S15-3/S15-4 | Revised | 1 |
| S15-5 thru S15-7 | Revised | 1 |
| * S15-8 thru S15-11 | Revised | 2 |
| S15-12 thru S15-13 | Revised | 1 |
| S15-14 thru S15-19 | Original Issue | 0 |
| S15-20 | Revised | 1 |
| S15-20A | Added | 1 |
| S15-20B | Added | 1 |
| * S15-21 | Revised | 2 |
| S15-22 | Original Issue | 0 |
| * S15-23 | Revised | 2 |
| S15-24 thru S15-26 | Original Issue | 0 |
| S15-27 thru S15-31 | Revised | 1 |
| * S15-32 | Revised | 2 |

APPROVED BY

FAA APPROVED UNDER PART 21, SUBPART J
The Cessna Aircraft Co.
Delegation Option Authorization FOA-100128-02
Richard A. Kelly Executive Director

DATE OF APPROVAL 10-31-02

CESSNA
MODEL 172R

SECTION 9 - SUPPLEMENTS
SUPPLEMENT 15 - FAA APPROVED

SUPPLEMENT 15

BENDIX/KING KAP 140 2 AXIS AUTOPILOT

SERVICE BULLETIN CONFIGURATION LIST

The following is a list of Service Bulletins that are applicable to the operation of the airplane, and have been incorporated into this supplement. This list contains only those Service Bulletins that are currently active.

| <u>Number</u> | <u>Title</u> | <u>Airplane Serial Effectivity</u> | <u>Revision Incorporation</u> | <u>Incorporated In Airplane</u> |
|--|--------------|--|-----------------------------------|-------------------------------------|
| KC-140-M1 (Honeywell Service Bulletin) | KAP 140 AP | | Revision 1 | |

8

1

2

3

4

5

6

SUPPLEMENT

BENDIX/KING KAP 140 2 AXIS AUTOPILOT

SECTION 1 GENERAL

The KAP 140, 2 Axis Autopilot provides the pilot with the following features: Vertical Speed mode (VS); Altitude hold (ALT); Wing Level (ROL); Heading select (HDG); Approach (APR); ILS coupling to Localizer (LOC) and Glideslope (GS); and backcourse (REV) modes of operation. The optional KAP 140, 2 Axis Autopilot with Altitude Preselect (if installed) adds Altitude Alerter and Altitude Preselect capabilities.

The KAP 140, 2 Axis Autopilot has an electric trim system which provides autotrim during autopilot operation and manual electric trim (MET) for the pilot when the autopilot is not engaged. The electric trim system is designed to be fail safe for any single in-flight trim malfunction. Trim faults are visually and aurally annunciated.

A lockout device prevents autopilot or MET engagement until the system has successfully passed preflight self test. Automatic preflight self-test begins with initial power application to the autopilot.

The following conditions will cause the Autopilot to disengage:

- A. Electric Power failure.
- B. Internal Autopilot System failure.

SECTION 9 - SUPPLEMENTS
SUPPLEMENT 15 - FAA APPROVED

CESSNA
MODEL 172R

C. Pitch accelerations in excess of +1.4g or less than +0.6g only when produced by a failure causing servo runaway. The pilot cannot maneuver the aircraft and trip the monitor.

D. Turn Coordinator failure (small square red flag visible on instrument).

E. Computer autopilot monitor that detects either the R (ROLL) or P (PITCH) axis annunciator.

Activation of A/P DISC/TRIM INT control wheel switch will also disconnect the autopilot.

The AVIONICS MASTER switch supplies power to the avionics bus bar of the radio circuit breakers and the autopilot circuit breaker. The AVIONICS MASTER switch also serves as an emergency AP/MET shutoff.

The following circuit breakers are used to protect the KAP 140 2-Axis Autopilot:

| <u>LABEL</u> | <u>FUNCTIONS</u> |
|---------------|---|
| AUTO PILOT | Pull-off circuit breaker supplies power to the KC 140 Computer and the autopilot pitch, roll and pitch trim servos. |
| WARN | Supplies separate power for autopilot alerting (PITCH TRIM) on the airplane's annunciator panel. |

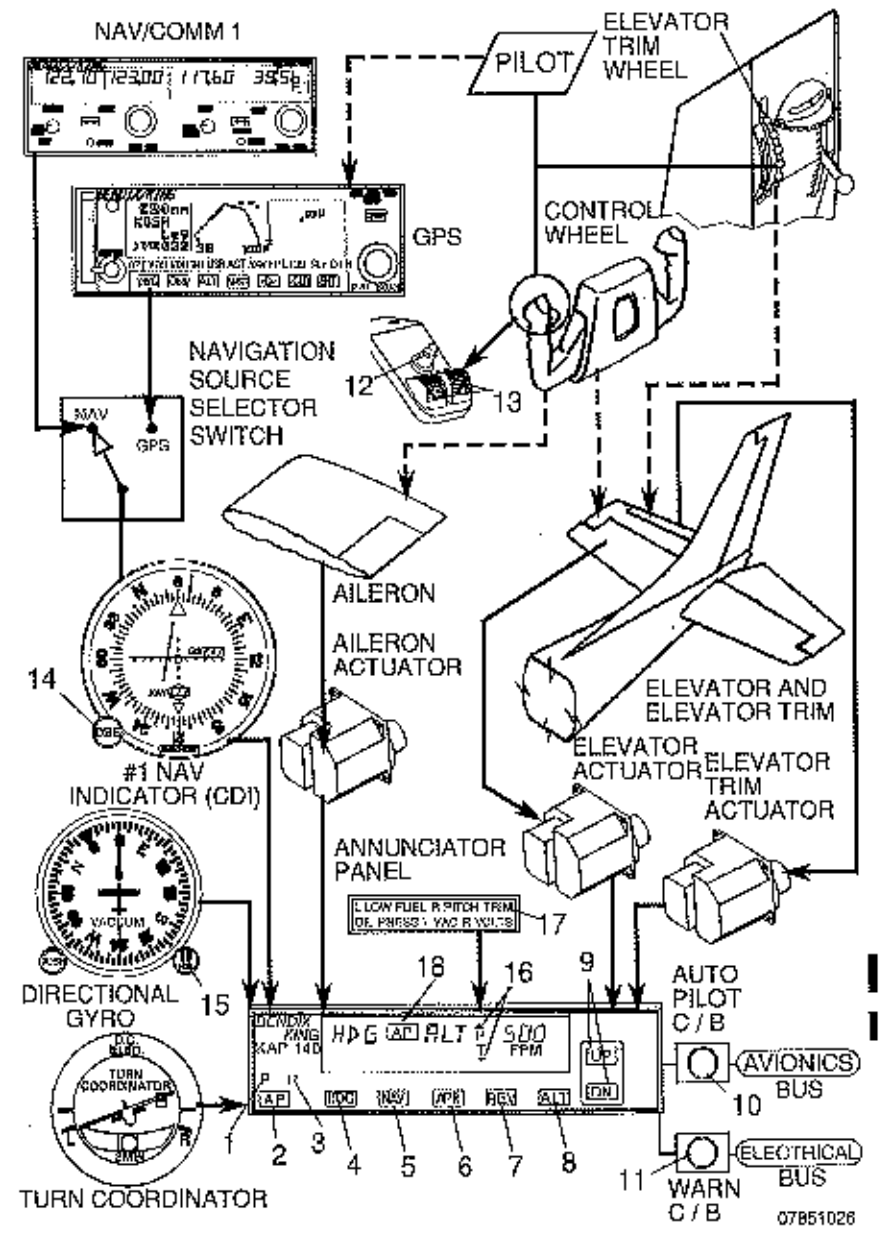

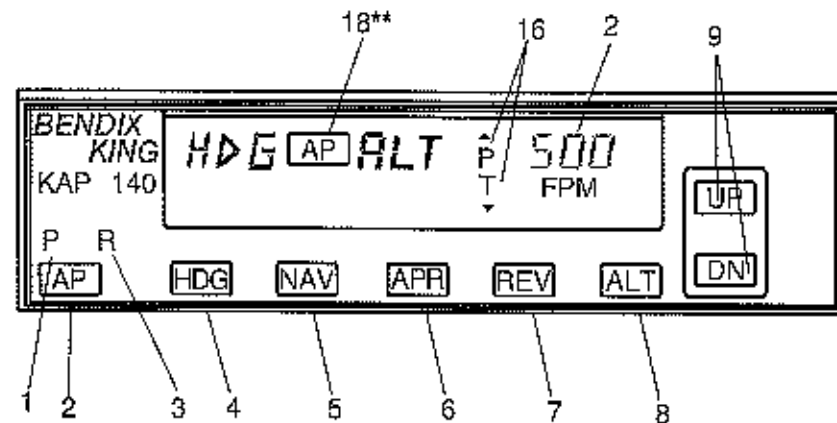

KAP 140 WITHOUT ALTITUDE PRESELECT

1. PITCH AXIS (P) ANNUNCIATOR -- When illuminated, indicates failure of pitch axis and will either disengage the autopilot or not allow engagement of the pitch axis. In turbulent air, will illuminate during abnormal vertical/accelerations.
2. AUTOPILOT ENGAGE/DISENGAGE (AP) BUTTON -- When pushed*, or pressed and held (approx. 0.25 seconds)**, engages autopilot if all preflight self-test conditions are met. The autopilot will engage in the basic roll (ROL) mode which functions as a wing leveler and the pitch axis vertical speed (VS) mode. The commanded vertical speed will be displayed in the upper right corner of autopilot display area. The captured VS will be the vertical speed present at the moment the AP button is pressed. The button may also be used to disengage the autopilot.
3. ROLL AXIS (R) ANNUNCIATOR -- When illuminated, indicates failure of the roll axis and disengages the autopilot.

* Airplane serials 17280831 thru 17281118 not incorporating Honeywell Service Bulletin KC140-M1.

** Airplane serials 17280831 thru 17281118 incorporating Honeywell Service Bulletin KC140-M1, and airplane serials 17281119 and on.

Figure 2. Bendix/King 2-Axis KAP 140 Autopilot, Operating Controls and Indicators (Sheet 1 of 4)

4. HEADING (HDG) MODE SELECTOR BUTTON -- When pushed, will select the Heading mode, which commands the airplane to turn to and maintain the heading selected by the heading bug on the Directional Gyro or HSI (if installed). A new heading may be selected at any time and will result in the airplane turning to the new heading. The button can also be used to toggle between HDG and ROL modes. For airplane serials 17280831 thru 17281118 not incorporating Honeywell Service Bulletin KC140-M1, this button can also be used to engage the autopilot in HDG mode.
5. NAVIGATION (NAV) MODE SELECTOR BUTTON -- When pushed, will select the Navigation mode. This mode provides automatic beam capture and tracking of VOR, LOC, or GPS signals as selected for presentation on the #1 CDI. NAV mode is recommended for enroute navigation tracking.
6. APPROACH (APR) MODE SELECTOR BUTTON -- When pushed, will select the Approach mode. This mode provides automatic beam capture and tracking of VOR, GPS, LOC and Glideslope (GS) on an ILS, as selected for presentation on #1 CDI. APR mode tracking sensitivity is recommended for instrument approaches.
7. BACK COURSE APPROACH (REV) MODE BUTTON -- This button is active only when the coupled navigation receiver is tuned to a LOC/ILS frequency. When pushed will select the Back Course approach mode. This mode functions identically to the approach mode except that the autopilot response to LOC signals is reversed. Glideslope is locked out with REV mode.
8. ALTITUDE HOLD (ALT) MODE SELECT BUTTON -- When pushed, will select the altitude hold mode. This mode provides capture and tracking of the selected altitude. The selected altitude is the airplane altitude at the moment the ALT button is pressed. If the ALT button is pressed with an established VS rate present, there will be about a 10% (of VS rate) overshoot. The airplane will return positively to the selected altitude. For airplane serials 17280831 thru 17281118 not incorporating Honeywell Service Bulletin KC140-M1, this button may be used to engage the autopilot in ALT mode.

Figure 2. Bendix/King 2-Axis KAP 140 Autopilot, Operating Controls and Indicators (Sheet 2)

9. VERTICAL SPEED (UP/DN) MODE BUTTONS -- The action of these buttons depends on the vertical mode present when pressed. If VS mode is active (AP plus any lateral mode) and the UP button is pressed, the autopilot will modify the displayed VS command (FPM) in the up direction. Single momentary cycles on either the UP or DN button will increment the VS command by 100 FPM per cycle. When either button is continuously held in, it will modify the vertical speed command by 300 fpm per second.

If ALT mode is active, pressing the UP/DN buttons will modify the captured altitude by 20 feet per cycle, or if held continuously will command the airplane up or down at the rate of 500 FPM, synchronizing the ALT reference to the actual airplane altitude upon button release.

10. AUTO PILOT CIRCUIT BREAKER -- A 5-amp pull-off circuit breaker supplying 28 VDC to the KAP 140 system.
11. WARN C/B -- Power to the autopilot disconnect horn and the airplane's annunciator panel (PITCH TRIM).
12. AUTOPILOT DISCONNECT (A/P DISC/TRIM INT) SWITCH -- When depressed will disengage the autopilot and interrupt manual electric trim (MET) power. An autopilot disconnect will be annunciated by a continuous 2 second tone accompanied by flashing "AP" annunciations on the autopilot computer display.
13. MANUAL ELECTRIC TRIM (MET) SWITCHES -- When both switches are pressed in the same direction the trim system will provide pitch trim in the selected direction. Use of manual electric trim during autopilot operation will disengage the autopilot.

Figure 2. Bendix/King 2-Axis KAP 140 Autopilot, Operating Controls and Indicators (Sheet 3)

14. OMNI BEARING SELECT (OBS) KNOB -- Selects the desired course to be tracked by the autopilot. (Note: The HDG bug must also be positioned to the proper course to capture and track the selected radial or desired track).
15. HEADING SELECT KNOB (HDG) -- Positions the heading pointer ("bug") on the compass card. Note that the position of the heading bug also provides course datum to the autopilot when tracking in NAV, APR, or REV (BC) modes. This is in addition to its more intuitive use in the HDG mode.
16. PITCH TRIM (PT) Annunciator -- Indicates the direction of required pitch trim. The annunciation will flash if auto trim has not satisfied the request for trim for a period of 10 seconds. A solid \overline{P} without an arrowhead is an indication of a pitch trim fault. Refer to the EMERGENCY PROCEDURES for proper response to a pitch trim fault.
17. PITCH TRIM Annunciation (located on instrument panel or glareshield) -- Illuminates whenever the automated preflight self test detects a pitch trim fault or the continuous monitoring system detects a pitch trim fault in flight. Refer to the EMERGENCY PROCEDURES for proper response to a pitch trim fault.
- **18. AUTOPILOT ENGAGE \overline{AP} Annunciation -- Illuminates whenever the autopilot is engaged. Flashes during pilot initiated or automatic disengagement.

** Airplane serials 17280831 thru 17281118 incorporating Honeywell Service Bulletin KC140-M1, and airplane serials 17281119 and on.

Figure 2. Bendix/King 2-Axis KAP 140 Autopilot, Operating Controls and Indicators (Sheet 4)

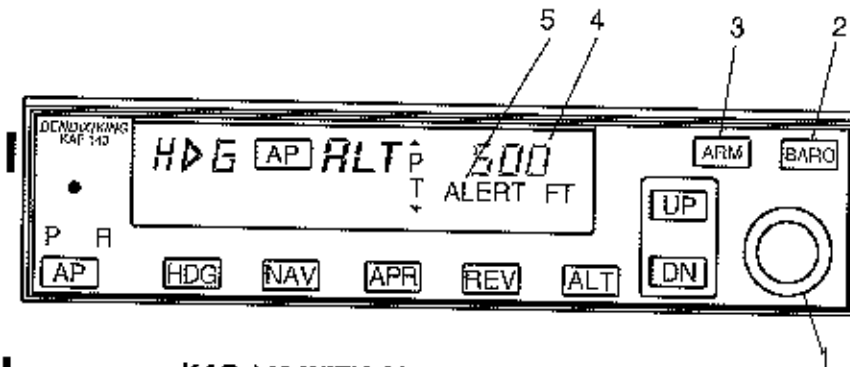

KAP 140 WITH ALTITUDE PRESELECT

NOTE

Numbered items apply to the KAP 140 with Altitude Preselect. Other controls and indicators shown are the same as those on the KAP 140 without Altitude Preselect (refer to Figure 2).

1. **ROTARY KNOBS** -- Used to set the altitude alerter reference altitude; or may be used immediately after pressing the **BARO** button, to adjust the autopilot baro setting to match that of the airplane's altimeter when manual adjustment is required. (In some systems, the baro setting may be automatically synched to that of the altimeter.)
2. **BARO SET (BARO) BUTTON** -- When pushed and released, will change the display from the altitude alerter selected altitude to the baro setting display (either IN HG or HPA) for 3 seconds. If pushed and held for 2 seconds, will change the baro setting display from IN HG to HPA or vice versa. Once the baro setting display is visible the rotary knobs may be used to adjust the baro setting.

Figure 3. Bendix/King 2-Axis KAP 140 Autopilot with Altitude Preselect, Operating Controls and Indicators (Sheet 1 of 2)

3. ALTITUDE ARM (**ARM**) BUTTON -- When pushed, will toggle altitude arming on or off. When ALT ARM is annunciated, the autopilot will capture the altitude alerter displayed altitude (provided the aircraft is climbing or descending in VS to the displayed altitude). ALT hold arming when the autopilot is engaged is automatic upon altitude alerter altitude selection via the rotary knobs. Note that the alerter functions are independent of the arming process thus providing full time alerting, even when the autopilot is disengaged.
4. ALTITUDE ALERTER/VERTICAL SPEED/BARO SETTING DISPLAY -- Normally displays the altitude alerter selected altitude. If the UP or DN button is pushed while in VS hold, the display changes to the command reference for the VS mode in FPM for 3 seconds. If the BARO button is pushed, the display changes to the autopilot baro setting in either IN HG or HPA for 3 seconds.

NOTE

This display may be dashed for up to 3 minutes on start up if a blind encoder is installed which requires a warm-up period.

5. ALTITUDE ALERT (**ALERT**) ANNUNCIATION -- Illuminates continuously in the region of from 200 to 1000 feet from the selected altitude if the airplane was previously outside of this region. Flashes (1) for two seconds the first time the airplane crossed the selected altitude and (2) continuously in the 200 to 1000 feet region if the airplane was previously inside of this region (i.e. at the selected altitude). Associated with the visual alerting is an aural alert (5 short tones) which occurs 1000 feet from the selected altitude upon approaching the altitude and 200 feet from the selected altitude on leaving the altitude.

Figure 3. Bendix/King 2-Axis KAP 140 Autopilot with Altitude Preselect, Operating Controls and Indicators (Sheet 2)

SECTION 2 LIMITATIONS

The following autopilot limitations must be adhered to:

1. The entire preflight test procedure outlined under Section 4, paragraph A of this supplement, including steps 1 through 7, must be successfully completed prior to each flight. Use of the autopilot or manual electric trim system is prohibited prior to completion of these tests.
2. During autopilot operation, a pilot with seat belt fastened must be seated at the left pilot position.
3. The autopilot must be OFF during takeoff and landing.
4. KMA 28 audio amplifier PUSH OFF/EMG operation is prohibited during normal operations.

NOTE

During emergency operation of the audio amplifier, the PUSH OFF/EMG state of the KMA 28 will prevent flight control system alerts from being heard.

5. The system is approved for Category I operation only (Approach mode selected).
6. Autopilot maximum airspeed limitation -- 140 KIAS.
Autopilot minimum airspeed limitation -- 70 KIAS.
Autopilot minimum approach speed -- 80 KIAS.
7. Maximum flap extension -- 10°.
8. The autopilot must be disengaged below 200 feet AGL during approach operations and below 800 feet AGL for all other phases of flight.
9. Overriding the autopilot to change pitch or roll attitude is prohibited. (Disengage with A/P DISC/TRIM INT or AP select button.)
10. The AUTO PILOT circuit breaker must be pulled following any inflight illumination of the red "PITCH TRIM" warning light, but only after first completing the Emergency Procedures (Section 3, paragraph f.). The manual electric trim and autopilot autotrim systems will be disabled with the AUTO PILOT circuit breaker pulled.

SECTION 3 EMERGENCY PROCEDURES

The four step procedure listed under paragraph A should be among the basic airplane emergency procedures that are committed to memory. It is important that the pilot be proficient in accomplishing all four steps without reference to this manual.

1. In case of Autopilot, Autopilot Trim, or Manual Electric Trim malfunction (accomplish Items A and B simultaneously):
 - A. Airplane Control Wheel -- **GRASP FIRMLY** and regain aircraft control.
 - B. **A/P DISC/TRIM INT** Switch -- **PRESS** and **HOLD** throughout recovery.
 - C. AIRCRAFT -- **RE-TRIM** Manually as Needed.
 - D. **AUTO PILOT** Circuit Breaker -- **PULL**.

NOTE

The **AVIONICS MASTER** Switch may be used as an alternate means of removing all electric power from the autopilot and electric trim systems. If necessary perform steps 1A through 1C above, then turn the **AVIONICS MASTER** Switch OFF before locating and pulling the **AUTO PILOT** Circuit Breaker. Turn the **AVIONICS MASTER** Switch on as soon as possible to restore power to all other avionics equipment. Primary attitude, airspeed, directional compass, and altitude instruments will remain operational at all times.

WARNING

DO NOT ATTEMPT TO RE-ENGAGE THE AUTOPILOT FOLLOWING AN AUTOPILOT, AUTOTRIM, OR MANUAL ELECTRIC TRIM MALFUNCTION UNTIL THE CAUSE FOR THE MALFUNCTION HAS BEEN CORRECTED.

Maximum Altitude losses due to autopilot malfunction:

| CONFIGURATION | ALT. LOSS |
|------------------------|-----------|
| Cruise, Climb, Descent | 350 ft. |
| Maneuvering | 100 ft. |
| Approach | 90 ft. |

AMPLIFIED EMERGENCY PROCEDURES

The following paragraphs are presented to supply additional information for the purpose of providing the pilot with a more complete understanding of the recommended course of action for an emergency situation.

1. An autopilot or autotrim malfunction occurs when there is an uncommanded deviation in the airplane flight path or when there is abnormal control wheel or trim wheel motion. In some cases, and especially for autopilot trim, there may be little to no airplane motion, yet the red **PITCH TRIM** annunciator (airplane's annunciator panel) may illuminate and an alert tone may sound.

The primary concern in reacting to an autopilot or autopilot trim malfunction, or to an automatic disconnect of the autopilot, is in maintaining control of the airplane. Immediately grasp the control wheel and press and hold down the A/P DISC/TRIM INT switch throughout the recovery. Manipulate the controls as required to safely maintain operation of the airplane within all of its operating limitations. Elevator trim should be used manually as needed to relieve control forces. **Locate and pull the AUTO PILOT circuit breaker** on the right hand circuit breaker panel to completely disable the autopilot system.

2. A manual electric trim malfunction may be recognized by illumination of the red **PITCH TRIM** annunciator, accompanied by an alert tone, or by unusual trim wheel motions with the autopilot OFF, without pilot actuation of the manual electric trim switches. As with an autopilot malfunction, the first concern following a manual electric trim malfunction is maintaining control of the airplane. Grasp the control wheel firmly and press and hold down the A/P DISC/TRIM INT switch. **Locate and pull the AUTO PILOT circuit breaker** on the right hand breaker panel.

3. Note that the emergency procedure for any malfunction is essentially the same: immediately grasp the control wheel and regain airplane control while pressing and holding the A/P DISC/TRIM INT switch down, and retrim the airplane as needed. After these steps have been accomplished secure the autopilot electric trim system by pulling the autopilot (AUTO PILOT) circuit breaker. As with any other airplane emergency procedure, it is important that the 4 steps of the emergency procedure located on Page 15 be committed to memory.
4. The AVIONICS MASTER switch may be used to remove all electric power from the Autopilot and Electric Trim systems while the circuit breaker is located and pulled. Return the AVIONICS MASTER switch to the ON position as soon as possible. With the AVIONICS MASTER switch off, all avionics and autopilot equipment will be inoperable.
5. It is important that all portions of the autopilot and electric trim system are preflight tested prior to each flight in accordance with the procedures published herein in order to assure their integrity and continued safe operation during flight.

▲ WARNING

DO NOT RESET AUTOPILOT CIRCUIT BREAKER FOLLOWING AN AUTOPILOT/AUTOTRIM OR MANUAL ELECTRIC TRIM MALFUNCTION UNTIL THE CAUSE FOR THE MALFUNCTION HAS BEEN CORRECTED.

A flashing $\frac{P}{T}$ auto trim annunciation on the face of the autopilot indicates a failure of the auto trim function to relieve pitch servo loading in a timely manner. This condition should be temporary.

1. FLASHING $\frac{P}{T}$ ANNUNCIATION -- **OBSERVE** aircraft pitch behavior. If pitch behavior is satisfactory, wait 5-10 seconds for the annunciation to stop.

2. If annunciation continues, Airplane Control Wheel -- **GRASP FIRMLY**, disengage the autopilot and check for an out of pitch trim condition. Manually retrim as required.
3. **AUTOPILOT OPERATION** -- **CONTINUE** if satisfied that the out of trim indication was temporary. **DISCONTINUE** if evidence indicates a failure of the auto trim function.

A red **P** or **R** on the face of the autopilot computer.

1. A red **P** is an indication that the pitch axis of the autopilot has been disabled and cannot be engaged. **DO NOT ENGAGE INTO A ROLL AXIS ONLY SYSTEM.**

NOTE

If the red **P** lamp was the result of some abnormal accelerations on the airplane, the annunciation should be extinguished within approximately one minute and normal use of the autopilot will be reestablished.

2. A red **R** is an indication that the roll axis of the autopilot has been disabled and cannot be engaged. The autopilot cannot be reengaged.

Flashing mode annunciation in the display of the autopilot computer.

1. Flashing **HDG** -- Indicates a failed heading. **PRESS HDG** button to terminate flashing. **ROL** will be displayed.
2. Flashing **NAV**, **APR** or **REV** -- Usually an indication of a flagged navigation source. **PRESS** the **NAV**, **APR** or **REV** button to terminate flashing. **ROL** will be displayed. (Select a valid navigation source.)

NOTE

A flashing **NAV**, **APR** or **REV** annunciation can also be caused by a failed heading valid input.

3. Flashing **GS** -- Indication of a flagged glideslope. (GS will rearm automatically if a valid GS signal is received.)

NOTE

To continue tracking the localizer, observe the appropriate minimums for a nonprecision approach. (Press ALT twice in rapid succession to terminate the flashing. Control the pitch axis in the default VS mode.)

NOTE

At the onset of mode annunciator flashing, the autopilot has already reverted to a default mode of operation, i.e., ROL and or VS mode. An immediate attempt to reengage to lost mode may be made if the offending navigation, glideslope or compass flag has cleared.

EXCEPTION

The HDG annunciation will flash for 5 seconds upon selection of NAV, APR, or REV modes to remind the pilot to set the HDG bug for use as course datum.

Effects of instrument losses upon autopilot operation:

1. Loss of the artificial horizon -- no effect on the autopilot.
2. Loss of the turn coordinator -- autopilot inoperative.
3. Loss of the Directional Gyro (DG)-- The directional gyro does not provide any system valid flag. If the DG fails to function properly the autopilot heading and navigation mode will not function correctly. Under these conditions, the only usable lateral mode is ROL.
4. Loss of Horizontal Situation Indicator (HSI) (if installed) -- If the HSI fails to function properly the autopilot heading and navigation mode will not function correctly. Under these conditions, the only usable lateral mode is ROL.
5. Loss of Blind Altitude Encoder -- Altitude Alerter and Altitude Preselect function inoperative.

NOTE

The following procedures apply to airplane serials 17280831 thru 17281118 incorporating Honeywell Service Bulletin KC140-M1, and serials 17281119 and on.

The following voice messages will be annunciated as conditions warrant:

1. **"TRIM IN MOTION"** - Elevator trim running for more than 5 seconds, message repeats every 5 seconds.
2. **"CHECK PITCH TRIM"** - An out of trim condition has existed for approximately 20 seconds, take immediate corrective action.
 - a. Airplane Control Wheel -- GRASP FIRMLY and regain aircraft control.
 - b. **A/P DISC/TRIM INT** Switch -- PRESS and HOLD throughout recovery.
 - c. AIRCRAFT -- **RE-TRIM** Manually as Needed.
 - d. **AUTO PILOT** Circuit Breaker -- PULL.

**SECTION 4
NORMAL PROCEDURES**

A. PREFLIGHT (PERFORM PRIOR TO EACH FLIGHT):

1. **AVIONICS MASTER** -- ON.
2. **POWER APPLICATION AND SELF TEST** -- A self test is performed upon power application to the computer. This test is a sequence of internal checks that validate proper system operation prior to allowing normal system operation. The sequence is indicated by "PFT" with an increasing number for the sequence steps. Successful completion of self test is identified by all display segments being illuminated (Display Test), external "Pitch Trim" (A/C System Annunciator Panel) being illuminated, and the disconnect tone sounding.

NOTE

Upon applying power to the autopilot, the red P warning on the face of the autopilot may illuminate indicating that the pitch axis cannot be engaged. This condition should be temporary, lasting approximately 30 seconds. The P will extinguish and normal operation will be available.

⚠ WARNING

IF PITCH TRIM LIGHT STAYS ON, THEN THE AUTOTRIM DID NOT PASS PREFLIGHT TEST. THE AUTOPILOT CIRCUIT BREAKER MUST BE PULLED. MANUAL ELECTRIC TRIM AND AUTOPILOT ARE INOPERATIVE.

3. MANUAL ELECTRIC TRIM -- TEST as follows:

- a. LH SWITCH -- PUSH FORWARD to DN position and hold. OBSERVE NO MOVEMENT of Elevator Trim Wheel. Release switch to Center OFF Position.

NOTE

If movement of the elevator trim wheel is observed during a check of either LH or RH Switch, the manual electric trim system has malfunctioned. The flight may be continued if the AUTOPILOT Circuit Breaker is pulled to the OFF position and secured until repairs can be made.

- b. LH SWITCH -- PULL AFT to UP position and hold. OBSERVE NO MOVEMENT of the Elevator Trim Wheel. Release switch to center OFF position.
- c. RH SWITCH -- PUSH FORWARD to DN position and hold for 5 seconds. OBSERVE NO MOVEMENT of Elevator Trim Wheel. Verify red "P R" light above AP button. Release switch to center OFF position.

(Continued Next Page)

NOTE

If red "P R" light is not observed after holding RH switch for 5 seconds, the trim monitor system has failed. The flight may be continued if the AUTOPILOT Circuit Breaker is pulled to the OFF position until repairs can be made.

- d. RH SWITCH -- PULL AFT to UP position and hold for 5 seconds. OBSERVE NO MOVEMENT of Elevator Trim Wheel. Verify red "P R" light above AP button. Release switch to center OFF position.
- e. LH and RH Switch -- PUSH FORWARD SIMULTANEOUSLY and HOLD. OBSERVE MOVEMENT of Elevator Trim Wheel in proper direction (nose down). While holding LH and RH Switches forward, PRESS and HOLD A/P DISC/TRIM INT Switch. OBSERVE NO MOVEMENT of Elevator Trim Wheel. Continue to hold LH and RH Switches forward and RELEASE A/P DISC/TRIM INT Switch. OBSERVE MOVEMENT of Elevator Trim Wheel in proper direction. Release LH and RH Switches to center OFF position.

NOTE

During Steps e. and f., verify movement of elevator trim tab in proper direction (the elevator trim tab will move up for nose down trim). If movement of Elevator Trim Wheel is observed while the A/P DISC/TRIM INT Switch is pressed, the manual electric trim system has failed. The flight may be continued if the AUTOPILOT Circuit Breaker is pulled to the OFF position until repairs can be made.

- f. LH and RH Switch -- PULL AFT SIMULTANEOUSLY and HOLD. OBSERVE MOVEMENT of Elevator Trim Wheel in proper direction (nose up). While holding LH and RH Switches aft, PRESS and HOLD A/P DISC/TRIM INT Switch. OBSERVE NO MOVEMENT of Elevator Trim Wheel. Continue to hold LH and RH Switches aft and RELEASE A/P DISC/TRIM INT Switch. OBSERVE MOVEMENT of Elevator Trim Wheel in proper direction. Release LH and RH Switches to center OFF position.

4. **FLASHING BARO SETTING** (if installed) -- **SET** proper baro setting manually (or press BARO to accept the present value).
5. **AUTOPILOT -- ENGAGE** by pressing*, or pressing and holding** AP button.
6. **FLIGHT CONTROLS -- MOVE** fore, aft, left and right to verify the autopilot can be overpowered.
7. **A/P DISC/TRIM INT** Switch -- **PRESS**. Verify that the autopilot disconnects.
8. **TRIM -- SET** to take off position manually.

⚠ WARNING

THE PILOT IN COMMAND MUST CONTINUOUSLY MONITOR THE AUTOPILOT WHEN IT IS ENGAGED, AND BE PREPARED TO DISCONNECT THE AUTOPILOT AND TAKE IMMEDIATE CORRECTIVE ACTION -- INCLUDING MANUAL CONTROL OF THE AIRPLANE AND/OR PERFORMANCE OF EMERGENCY PROCEDURES -- IF AUTOPILOT OPERATION IS NOT AS EXPECTED OR IF AIRPLANE CONTROL IS NOT MAINTAINED.

⚠ WARNING

DURING ALL AUTOPILOT COUPLED OPERATIONS, THE PILOT IN COMMAND MUST USE PROPER AUTOPILOT COMMANDS AND USE THE PROPER ENGINE POWER TO ENSURE THAT THE AIRPLANE IS MAINTAINED BETWEEN 80 AND 160 KIAS, AND DOES NOT EXCEED OTHER BASIC AIRPLANE OPERATING LIMITATIONS.

* Airplane serials 17280831 thru 17281118 not incorporating Honeywell Service Bulletin KC140-M1.

** Airplane serials 17280831 thru 17281118 incorporating Honeywell Service Bulletin KC140-M1, and airplane serials 17281119 and on.

NOTE

Autopilot tracking performance will be degraded in turbulence.

1. BEFORE TAKEOFF:

- a. **A/P DISC/TRIM INT** Switch -- **PRESS**.
- b. **BARO** setting (if installed) -- **CHECK**.

⚠ CAUTION

CONTINUE TO SET MANUALLY THROUGHOUT THE FLIGHT EACH TIME THE ALTIMETER BARO SETTING REQUIRES ADJUSTMENT. NO FURTHER REMINDERS (FLASHING) WILL BE GIVEN.

- c. **ALTITUDE SELECT** KNOB (if installed) -- **ROTATE** until the desired altitude is displayed.

NOTE

An altitude alert is annunciated 1000 ft. prior to arrival at the selected altitude. Aircraft deviations greater than 200 feet above or below the selected altitude will produce an altitude alert. The alert annunciation is accompanied by a series of short tones.

2. AFTER TAKEOFF:

- a. Elevator Trim -- **VERIFY** or **SET** to place the airplane in a trimmed condition prior to Autopilot engagement.

NOTE

Engaging the autopilot into a mistrim condition may cause unwanted attitude changes and a "TRIM FAIL" annunciation.

- b. Airspeed and Rate of Climb -- **STABILIZED**.

NOTE

Avoid autopilot engagement into a climb condition that either cannot be maintained, or is on the performance limits of the airplane for its power and weight configuration.

- c. **AP** Button -- **PRESS***, or **PRESS and HOLD****. Note **ROL** and **VS** annunciator on. If no other modes are selected the autopilot will operate in the **ROL** and **VS** modes.

▲ WARNING

WHEN OPERATING AT OR NEAR THE BEST RATE OF CLIMB AIRSPEED, AT CLIMB POWER SETTINGS, AND USING VERTICAL SPEED (VS) MODE, CONTINUED OPERATION IN VERTICAL SPEED MODE CAN RESULT IN AN AIRPLANE STALL. IF NECESSARY, DISCONNECT THE AUTO PILOT AND RETURN THE AIRPLANE TO A STABILIZED CLIMB PRIOR TO RE-ENGAGEMENT.

▲ WARNING

WHEN OPERATING AT OR NEAR THE MAXIMUM AUTOPILOT SPEED, IT WILL BE NECESSARY TO REDUCE POWER IN ORDER TO MAINTAIN THE DESIRED RATE OF DESCENT AND NOT EXCEED THE MAXIMUM AUTOPILOT SPEED.

▲ WARNING

DO NOT HELP THE AUTOPILOT OR HAND-FLY THE AIRPLANE WITH THE AUTOPILOT ENGAGED AS THE AUTOPILOT WILL RUN THE PITCH TRIM TO OPPOSE CONTROL WHEEL MOVEMENT. A MISTRIM OF THE AIRPLANE, WITH ACCOMPANYING LARGE ELEVATOR CONTROL FORCES, MAY RESULT IF THE PILOT MANIPULATES THE CONTROL WHEEL MANUALLY WHILE THE AUTOPILOT IS ENGAGED.

* Airplane serials 17280831 thru 17281118 not incorporating Honeywell Service Bulletin KC140-M1.

** Airplane serials 17280831 thru 17281118 incorporating Honeywell Service Bulletin KC140-M1, and airplane serials 17281119 and on.

3. CLIMB OR DESCENT:

a. **BARO** setting (if installed) -- **CHECK**.

b. Using Vertical Trim:

1) **VERTICAL SPEED** Control -- **PRESS** either the **UP** or **DN** button to select aircraft vertical speed within the +1500 /-2000 ft. per min command limits .

2) **VERTICAL SPEED** Control -- **RELEASE** when desired vertical speed is displayed. The autopilot will maintain the selected vertical speed.

NOTE

Avoid selecting a climb rate that either cannot be maintained or is on the performance limit of the airplane for its power and weight configuration.

4. ALTITUDE HOLD:

a. Capture preselected altitudes (if installed):

1) **ALTITUDE SELECT** knob -- **ROTATE** until the desired altitude is displayed. Note **ARM** annunciation occurs automatically with altitude selection when the autopilot is engaged.

2) **ALTITUDE SELECT MODE (ARM)** button -- **PUSH** to alternately disarm or arm altitude capture.

3) Airplane -- **ESTABLISH** vertical speed necessary to intercept the selected altitude.

NOTE

It may be possible to observe minor difference between the autopilot's selected altitude and the aircraft altimeter after an altitude capture. These discrepancies are attributed to the autopilot and altimeter using different static sources combined with autopilot system tolerances. Not inputting the proper barometric setting into the autopilot computer will produce inaccuracies.

NOTE

Altitude preselect captures are not recommended on nonprecision approaches to capture the MDA. Glideslope coupling will preclude a preselect altitude capture on an ILS.

b. Altitude (**ALT**) Hold Button:

- 1) **ALT** Hold Selector Button -- **PRESS**. Note **ALT** hold annunciator **ON**. Autopilot will maintain the selected altitude.

NOTE

It is recommended by the FAA (AC00-24B) to use basic "PITCH ATTITUDE HOLD" mode during operation in severe turbulence. However, since this autopilot does **not** use the attitude gyro as a pitch reference, it is recommended that the autopilot be disconnected and that the airplane be flown by hand in severe turbulence.

c. Changing altitudes:

- 1) Using Vertical Speed (Recommended for altitude changes less than 100 ft.)
 - a) **VERTICAL SPEED** Control -- **PRESS** and **HOLD** either the **UP** or **DN** button. Vertical Speed will seek a rate of change of about 500 fpm.
 - b) **VERTICAL SPEED** Control -- **RELEASE** when desired altitude is reached. The autopilot will maintain the desired altitude.

NOTE

As an alternative, a series of quick momentary presses on the **UP** or **DN** button will program either an increase or decrease of the altitude reference, 20 feet each time the button is pressed.

5. HEADING HOLD:

- a. Heading Selector Knob -- **SET BUG** to desired heading.
- b. **HDG** Mode Selector Button -- **PRESS**. Note **HDG** mode annunciator **ON**. Autopilot will automatically turn the aircraft to the selected heading.

NOTE

Aircraft heading may change in ROL mode due to turbulence.

- c. Heading Selector Knob -- **MOVE BUG** to the desired heading. Autopilot will automatically turn the aircraft to the new selected heading.

6. NAV COUPLING:

- a. When equipped with DG:
 - 1) **OBS** Knob -- **SELECT** desired course.
 - 2) **NAV** Mode Selector Button -- **PRESS**. Note **NAVARM** annunciated.
 - 3) Heading Selector Knob -- **ROTATE BUG** to agree with **OBS** course.

NOTE

When NAV is selected, the autopilot will flash HDG for 5 seconds to remind the pilot to reset the HDG bug to the OBS course. IF HDG mode was in use at the time of NAV button selection, a 45° intercept angle will then be automatically established based on the position of the bug.

NOTE

All angle intercepts compatible with radar vectors may be accomplished by selecting ROL mode **PRIOR** to pressing the NAV button. The HDG bug must still be positioned to agree with the OBS course to provide course datum to the autopilot when using a DG (Directional Gyro).

- a) If the CDI needle is greater than 2 to 3 dots from center, the autopilot will annunciate **NAVARM**. When the computed capture point is reached the **ARM** annunciator will go out and the selected course will be automatically captured and tracked.
 - b) If the CDI needle is less than 2 to 3 dots from center, the HDG mode will disengage upon selecting NAV mode. The **NAV** annunciator will then illuminate and the capture/track sequence will automatically begin.
- b. When equipped with HSI:
- 1) Course Bearing Pointer - **SET** to desired course.
 - 2) Heading Selector Knob -- **SET BUG** to provide desired intercept angle and engage HDG mode.
 - 3) **NAV** Mode Selector Button -- **PRESS**.
 - a) If the Course Deviation Bar (D-Bar) is greater than 2 to 3 dots from center, the autopilot will annunciate **NAVARM**. When the computed capture point is reached the **ARM** annunciator will go out and the selected course will be automatically captured and tracked.
 - b) If the D-Bar is less than 2 to 3 dots from center, the HDG mode will disengage upon selecting NAV mode. The **NAV** annunciator will then illuminate and the capture/track sequence will automatically begin.

7. APPROACH (APR) COUPLING: (To enable glideslope coupling on an ILS and more precise tracking on instrument approaches).

a. When equipped with DG:

- 1) **BARO** setting -- **CHECK** (if installed).
- 2) **OBS** Knob -- **SELECT** desired approach course. (For a localizer, set it to serve as a memory aid.)
- 3) **APR** Mode Selector Button -- **PRESS**. Note **APR** annunciator.
- 4) Heading Selector Knob -- **ROTATE BUG** to agree with desired approach.

NOTE

When APR is selected, the autopilot will flash HDG for 5 seconds to remind the pilot to reset the HDG bug to the approach course. If HDG mode was in use at the time of APR button selection, a 45° intercept angle will then be automatically established based on the position of the bug.

NOTE

All angle intercepts compatible with radar vectors may be accomplished by selecting ROL mode PRIOR to pressing the APR button. The HDG bug must still be positioned to agree with the desired approach course to provide course datum to the autopilot when using a DG.

- a) If the CDI needle is greater than 2 to 3 dots from center, the autopilot will announce **APR** ARM, when the computed capture point is reached the **ARM** annunciator will go out and the selected course will be automatically captured and tracked.
- b) If the CDI needle is less than 2 to 3 dots from center, the HDG mode will disengage upon selecting APR mode; the **APR** annunciator will illuminate and the capture/track sequence will automatically begin.

b. When equipped with HSI:

- 1) **BARO** Setting (if installed) -- **CHECK**.
- 2) Course Bearing Pointer -- **SET** to desired course.
- 3) Heading Selector Knob -- **SET BUG** to provide desired intercept angle.
- 4) **APR** Mode Selector Button -- **PRESS**.
 - a) If the D-Bar is greater than 2 to 3 dots from center, the autopilot will annunciate **APRARM**; when the computed capture point is reached the **ARM** annunciator will go out and the selected course will be automatically captured and tracked.
 - b) If the D-Bar is less than 2 to 3 dots from center, the HDG mode will disengage upon selecting APR mode; the **APR** annunciator will illuminate and the capture/track sequence will automatically begin.
- 5) Airspeed -- **MAINTAIN** 90 KIAS minimum during coupled autopilot approaches (recommended).

8. BACK COURSE (REV) APPROACH COUPLING (i.e., reverse localizer):

a. When equipped with DG:

- 1) **BARO** setting (if installed) -- **CHECK**.
- 2) **OBS** Knob -- **SELECT** the localizer course to the front course inbound (as a memory aid).
- 3) **REV** Mode Selector Button -- **PRESS**.
- 4) Heading Selector Knob -- **ROTATE BUG** to the heading corresponding to the localizer front course inbound.

NOTE

When REV is selected, the autopilot will flash HDG for 5 seconds to remind the pilot to reset the HDG bug to the localizer FRONT COURSE INBOUND heading. If heading mode was in use at the time of REV button selection, a 45° intercept angle will then be automatically established based on the position of the bug.

NOTE

All angle intercepts compatible with radar vectors may be accomplished by selecting ROL mode PRIOR to pressing the REV button. The HDG bug must still be positioned to the localizer FRONT COURSE INBOUND heading to provide course datum to the autopilot when using a DG.

a) If the CDI needle is greater than 2 to 3 dots from center, the autopilot will annunciate **REVARM**; when the computed capture point is reached the **ARM** annunciator will go out and the selected back course will be automatically captured and tracked.

b) If the CDI needle is less than 2 to 3 dots from center, the HDG mode will disengage upon selecting **REV** mode; the **REV** annunciator will illuminate and the capture/track sequence will automatically begin.

b. When equipped with HSI:

- 1) **BARO** Setting (if installed) -- **CHECK**.
- 2) Course Bearing pointer -- **SET** to the ILS front course inbound heading.
- 3) Heading Selector Knob -- **SET BUG** to provide desired intercept angle and engage HDG mode.
- 4) **REV** Mode Selector Button -- **PRESS**.

- a) If the D-Bar is greater than 2 to 3 dots from center, the autopilot will annunciate **REVARM**; when the computed capture point is reached the **ARM** annunciator will go out and the selected back course will be automatically captured and tracked.
- b) If the D-Bar is less than 2 to 3 dots from center, the HDG mode will disengage upon selecting **REV** mode; the **REV** annunciator will illuminate and the capture/track sequence will automatically begin.
- 5) Airspeed -- **MAINTAIN** 90 KIAS minimum during autopilot coupled approaches (recommended).

9. GLIDESLOPE COUPLING

- a. **APR** Mode -- **ENGAGED**, Note **GS_{ARM}** annunciated.

NOTE

Glideslope coupling is inhibited when operating in NAV or REV modes. With NAV 1 selected to a valid ILS, glideslope armed and coupling occurs automatically in the APR mode when tracking a localizer.

- b. At Glideslope centering -- note **ARM** annunciator goes out.

NOTE

Autopilot can capture glideslope from above or below the beam.

- c. Airspeed -- **MAINTAIN** 90 KIAS minimum during autopilot coupled approaches (recommended).

10. MISSED APPROACH
- a. **A/P DISC/TRIM INTER** Switch - **PRESS** to disengage AP.
 - b. **MISSED APPROACH - EXECUTE.**
 - c. If autopilot is desired:
 - 1) Elevator Trim -- **VERIFY** or **SET.**
 - 2) Airspeed and Rate of Climb -- **STABILIZED.**

NOTE

Avoid autopilot engagement into a climb condition that either cannot be maintained, or is on the performance limits of the airplane for its power and weight configuration.

- 3) AP Button -- **PRESS***, or **PRESS and HOLD**.** Note **ROL** and **VS** annunciators on. If no other modes are selected the autopilot will operate in the ROL and VS modes. Verify that the aircraft Vertical Speed Indicator (VSI) and the Autopilot VS agree.

NOTE

If tracking the ILS course outbound as part of the missed approach procedure is desired, use the NAV mode to prevent inadvertent GS coupling.

11. BEFORE LANDING
- a. **A/P DISC/TRIM INT** Switch -- **PRESS** to disengage AP.

**SECTION 5
PERFORMANCE**

There is no change to the airplane performance when the KAP 140, 2 Axis Autopilot is installed.

- * Airplane serials 17280831 thru 17281118 not incorporating Honeywell Service Bulletin KC140-M1.
- ** Airplane serials 17280831 thru 17281118 incorporating Honeywell Service Bulletin KC140-M1, and airplane serials 17281119 and on.

Pilot's Operating Handbook and FAA Approved Airplane Flight Manual Supplement for Cessna 172R

FAA APPROVED
PILOT'S OPERATING HANDBOOK and
AIRPLANE FLIGHT MANUAL SUPPLEMENT
FOR
CESSNA 172R
AIRPLANES 17280001 AND ON

REGISTRATION NO: N71755

SERIAL NO: 17280800

This Supplement must be attached to the "Pilot's Operating Handbook and FAA Approved Airplane Flight Manual" dated December 2, 1998 (or later FAA approved revision) when the Textron Lycoming IO-360-L2A engine rated at 180 HP and McCauley 1A170E/JHA7660 propeller are installed in accordance with Supplemental Type Certificate SA10406SC

The information contained herein supplements or supersedes the information in the basic manual only in those areas listed. For limitations, procedures, performance and loading information not contained in this supplement, consult the basic "Pilot's Operating Handbook and FAA Approved Airplane Flight Manual".

FAA APPROVED

Fred Steller, Acting Manager
Special Certification Office
Federal Aviation Administration
Fort Worth, Texas 76193-0190

FAA APPROVED

DATE: May 6, 2006



551 AIRPORT DR. DALLAS, TX 75234

AFMS No.: 90001-3
Rev.: 1R
Page: 2 of 36

Pilot's Operating Handbook and FAA Approved Flight Manual Supplement for Cessna 172R

LOG OF REVISIONS

| Revision Number | Change Description | Pages Affected | FAA Approval and Date |
|-----------------|--------------------|----------------|-------------------------------|
| 1R | Initial Release | All | See Cover Page May 6, 2005 |

FAA APPROVED

DATE: May 6, 2005



331 Airport Dr. Denton, TX 76234

AFMS No.: 99001-3
Rev.: IR
Page: 3 of 36

Pilot's Operating Handbook and FAA Approved Flight Manual Supplement for Cessna 172R

**SECTION 1
GENERAL**

| TABLE OF CONTENTS | PAGE |
|--------------------------------|------|
| Descriptive Data..... | 4 |
| Engine..... | 4 |
| Propeller..... | 4 |
| Maximum Certified Weights..... | 4 |

FAA APPROVED
DATE: May 6, 2005



251 Airway Dr. Dallas, TX 75224

AFMS No.: 00001-3
Rev.: IR
Page: 4 of 36

Pilot's Operating Handbook and FAA Approved Flight Manual Supplement for Cassra 172R

DESCRIPTIVE DATA

ENGINE

Engine Manufacturer: Textron Lycoming
Engine Model Number: IO-360-L2A
Engine Type: Normally aspirated, direct drive, air-cooled, horizontally opposed,
fuel injected, four cylinder engine with 360 cu. in. displacement
Horsepower Rating and Engine Speed: 180 rated BHP at 2700 RPM

PROPELLER

Propeller Manufacturer: McCauley Propeller Systems
Propeller Model Number: 1A170E/JHA7680
Number of Blades: 2
Propeller Diameter: 76 inches
Propeller Type: Fixed pitch

MAXIMUM CERTIFICATED WEIGHTS

| | | |
|----------------|-------------------|-----------|
| Ramp Weight | Normal Category: | 2550 lbs. |
| | Utility Category: | 2200 lbs. |
| Takeoff Weight | Normal Category: | 2550 lbs. |
| | Utility Category: | 2200 lbs. |
| Landing Weight | Normal Category: | 2550 lbs. |
| | Utility Category: | 2200 lbs. |

FAA APPROVED

DATE: May 6, 2005

SECTION 2
LIMITATIONS

| TABLE OF CONTENTS | PAGE |
|-------------------------------------|-------------|
| Airspeed Limitations..... | 6 |
| Airspeed Indicator Markings..... | 7 |
| Powerplant Limitations..... | 7 |
| Powerplant Instrument Markings..... | 8 |
| Weight Limits..... | 8 |
| Normal Category..... | 8 |
| Utility Category..... | 9 |
| Center of Gravity Limits..... | 9 |
| Normal Category..... | 9 |
| Utility Category..... | 9 |
| Flight Load Factor Limits..... | 9 |
| Normal Category..... | 9 |
| Utility Category..... | 9 |
| Placards..... | 9 |

AIR SPEED LIMITATIONS

Air speed limitations and their operational significance are shown in Figure 1. Maneuvering speeds shown apply to normal category operations. The utility category maneuvering speed is 98 KIAS at 2200 lbs.

| Symbol | Speed | KCAS | KIAS | Remarks |
|-----------------|---|-----------------|-----------------|---|
| V _{NE} | Never Exceed Speed | 160 | 163 | Do not exceed this speed in any operation |
| V _{NO} | Maximum Structural Cruising Speed | 128 | 129 | Do not exceed this speed except in smooth air, and then only with caution |
| V _A | Maneuvering Speed; 2550 lbs. 2200 lbs. 1900 lbs. | 102 95 88 | 105 98 90 | Do not make full or abrupt control movements above this speed |
| V _{FE} | Maximum Flap Extended Speed; 10° Flaps 10° to 30° Flaps | 107 85 | 110 85 | Do not exceed this speed with flaps down. |
| | Maximum Window Open Speed | 160 | 163 | Do not exceed this speed with windows open |

Figure 1
Airspeed Limitations

AIRSPEED INDICATOR MARKINGS

Airspeed indicator markings and their color code significance are shown in Figure 2.

| MARKING | KIAS VALUE OR RANGE | SIGNIFICANCE |
|------------|---------------------|---|
| White Arc | 40-85 | Full Flap Operating Range. Lower limit is maximum weight V_{SO} in landing configuration. Upper limit is maximum speed permissible with flaps extended. |
| Green Arc | 48-129 | Normal Operating Range. Lower limit is maximum weight V_S at most forward C.G. with flaps retracted. Upper limit is maximum structural cruising speed. |
| Yellow Arc | 129-163 | Operations must be conducted with caution and only in smooth air. |
| Red Line | 163 | Maximum speed for all operations. |

Figure 2
Airspeed Indicator Markings

POWERPLANT LIMITATIONS

Engine Manufacturer: Textron Lycoming
Engine Model Number: IO-380-L2A
Maximum Power: 180 BHP rating
Engine Operating Limits for
Takeoff and Continuous Operations: Maximum Engine Speed: 2700 RPM

Note

The static RPM range at full throttle is 2300 – 2400 RPM

Propeller Manufacturer: McCauley Propeller Systems
Propeller Model Number: 1A170E/JHA7660
Propeller Diameter: Maximum 76 inches
Minimum 75 inch minimum

FAA APPROVED

DATE: May 6, 2005

POWERPLANT INSTRUMENT MARKINGS

| INSTRUMENT | RED LINE (MINIMUM) | GREEN ARC (NORMAL OPERATING) | RED LINE (MAX) |
|--|---------------------------------------|--|----------------|
| Tachometer: Sea-Level 5000 Feet 10,000 Feet | --- | 2100 to 2500 RPM 2100 to 2800 RPM 2100 to 2700 RPM | 2700 RPM |
| Oil Temperature | --- | 100 to 245°F | 245°F |
| Oil Pressure | 20 PSI | 50 to 90 PSI | 115 PSI |
| Fuel Quantity | 0 (1.5 Gal. Unusable Each Tank) | | |
| Fuel Flow | --- | 0 to 12 GPH | --- |
| Vacuum Gauge | --- | 4.5 - 5.5 in. Hg. | --- |

Figure 3
Powerplant Instrument Markings

WEIGHT LIMITS

Normal Category

Maximum Ramp Weight: 2550 lbs.
Maximum Takeoff Weight: 2550 lbs.
Maximum Landing Weight: 2550 lbs.
Maximum Weight in Baggage Compartment:
Baggage Area 1 - Station 82 to 108: 120 lbs.
Baggage Area 2 - Station 108 to 142: 50 lbs.

Note

The maximum combined weight capacity for baggage areas 1 and 2 is 120 lbs.

Utility Category

Maximum Ramp Weight: 2200 lbs.
Maximum Takeoff Weight: 2200 lbs.
Maximum Landing Weight: 2200 lbs.
Maximum Weight in Baggage Compartment: In the utility category, the baggage compartment must be empty and rear seat must not be occupied.

FAA APPROVED

DATE: May 6, 2005



391 Airport Dr., Lubbock, TX 79424

AFMS No.: 99001-3
Rev.: IR
Page: 9 of 38

Pilot's Operating Handbook and FAA Approved Flight Manual Supplement for Cessna 172R

CENTER OF GRAVITY LIMITS

Normal Category

Center of Gravity Range:

Forward: 35.0 inches aft of datum at 1950 lbs. or less, with straight line variation to 41.0 inches aft of datum at 2550 lbs.

Aft: 47.3 inches aft of datum at all weights.

Reference Datum: Lower portion of front face of firewall.

Utility Category

Center of Gravity Range:

Forward: 35.0 inches aft of datum at 1950 lbs. or less, with straight line variation to 37.5 inches aft of datum at 2200 lbs.

Aft: 40.5 inches aft of datum at all weights.

Reference Datum: Lower portion of front face of firewall.

FLIGHT LOAD FACTOR LIMITS

Normal Category

Flight Load Factors (Maximum Takeoff Weight - 2550 lbs.):

Flaps Up.....+3.8g, -1.52g

Flaps Down.....+3.0g

Utility Category

Flight Load Factors (Maximum Takeoff Weight - 2200 lbs.):

Flaps Up.....+4.4g, -1.78g

Flaps Down.....+3.0g

PLACARDS

Near Airspeed Indicator:

MANEUVERING SPEED - 105 KIAS

FAA APPROVED

DATE: May 6, 2005

**SECTION 3
EMERGENCY PROCEDURES**

| TABLE OF CONTENTS | PAGE |
|---|-------------|
| Introduction..... | 11 |
| AIRSPEEDS | |
| Airspeeds for Emergency Operation..... | 11 |
| EMERGENCY PROCEDURES CHECKLIST | |
| Engine Failures..... | 11 |
| Engine Failure Immediately after Takeoff..... | 11 |
| Engine Failure During Flight..... | 11 |
| Forced Landings..... | 11 |
| Emergency Landing Without Engine Power..... | 11 |
| Precautionary Landing With Engine Power..... | 11 |
| Ditching..... | 12 |
| AMPLIFIED EMERGENCY PROCEDURES | |
| Engine Failure..... | 12 |

FAA APPROVED

DATE: May 8, 2005



381 Alamo Dr. Decatur, TX 78234

AFMS No.: 09001-3
Rev.: IR
Page: 11 of 36

Pilot's Operating Handbook and FAA Approved Flight Manual Supplement for Cessna 172R

INTRODUCTION

AIRSPEEDS

AIRSPEEDS FOR EMERGENCY OPERATION

| | |
|--|----------|
| Engine Failure After Takeoff: | |
| Wing Flaps Up..... | 70 KIAS |
| Wing Flaps Down..... | 65 KIAS |
| Maneuvering Speed: | |
| 2550 lbs..... | 105 KIAS |
| 2200 lbs..... | 98 KIAS |
| 1900 lbs..... | 90 KIAS |
| Maximum Glide..... | 68 KIAS |
| Precautionary Landing With Engine Power..... | 65 KIAS |
| Landing Without Engine Power: | |
| Wing Flaps Up..... | 70 KIAS |
| Wing Flaps Down..... | 65 KIAS |

EMERGENCY PROCEDURES CHECKLIST

Note: The airspeeds shown below are the only changes to the emergency procedures for the modified aircraft. Refer to the basic Flight Manual for the remainder of the procedures for those sections shown below.

ENGINE FAILURES

ENGINE FAILURE IMMEDIATELY AFTER TAKEOFF

1. Airspeed - 70 KIAS (flaps Up),
65 KIAS (flaps Down)

ENGINE FAILURE DURING FLIGHT (Restart Procedures)

1. Airspeed - 68 KIAS

FORCED LANDINGS

EMERGENCY LANDING WITHOUT ENGINE POWER

3. Airspeed - 70 KIAS (flaps Up),
65 KIAS (flaps Down)

PRECAUTIONARY LANDING WITH ENGINE POWER

3. Airspeed - 65 KIAS
8. Airspeed - 65 KIAS

FAA APPROVED

DATE: May 6, 2005

Pilot's Operating Handbook and FAA Approved Flight Manual Supplement for Cessna 172R

DITCHING

1. Power - Establish 300 Ft/Min Descent at 55 KIAS

NOTE

If no power is available, approach at 70 KIAS with flaps up or at 65 KIAS with 10° flaps.

AMPLIFIED EMERGENCY PROCEDURES

ENGINE FAILURE

After an engine failure in flight, the most important course of action is to continue flying the airplane. Best glide speed (68 KIAS) should be established as quickly as possible. While gliding toward a suitable landing area, an effort should be made to identify the cause of the failure. If time permits, an engine restart should be attempted as shown in the checklist. If the engine cannot be restarted, a forced landing without power must be completed.

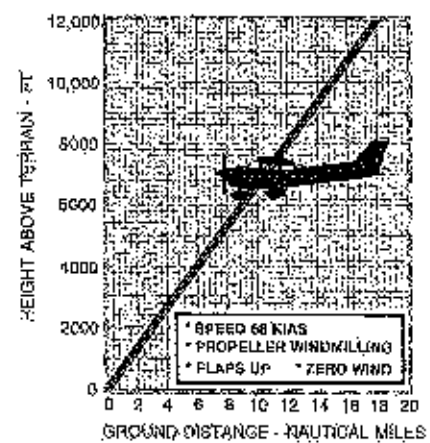

Figure 4
Maximum Glide

FAA APPROVED
DATE: May 6, 2005

.....

SECTION 4
NORMAL PROCEDURES

| TABLE OF CONTENTS | PAGE |
|-------------------------------------|-------------|
| Introduction..... | 11 |
| AIRSPEEDS | |
| Airspeeds for Normal Operation..... | 14 |
| CHECKLIST PROCEDURES | |
| Preflight Inspection..... | 14 |
| Noise..... | 14 |
| Takeoff..... | 14 |
| Normal Takeoff..... | 14 |
| Short Field Takeoff..... | 16 |
| Cruise..... | 15 |
| Landing..... | 15 |
| Short Field Landing..... | 15 |
| Balked Landing..... | 15 |
| AMPLIFIED PROCEDURES | |
| Takeoff..... | 15 |
| Power Check..... | 15 |
| Wing Flap Settings..... | 15 |
| Cruise..... | 16 |
| Landing..... | 16 |
| Short Field Landing..... | 16 |
| Noise Characteristics..... | 16 |



351 AIRCRAFT DR. DEFRAMO, TX 78224

AFMS No.: 98001-3
Rev.: IR
Page: 14 of 36

Pilot's Operating Handbook and FAA Approved Flight Manual Supplement for Cessna 172R

AIRSPEDS

AIRSPEDS FOR NORMAL OPERATION

Unless otherwise noted, the following speeds are based on a maximum weight of 2550 pounds and may be used for any lesser weight.

| | |
|---|--------------|
| Takeoff: | |
| Normal Climb Out..... | 75 - 85 KIAS |
| Short Field Takeoff, Flaps 10°, Speed at 50 Feet..... | 58 KIAS |
| Enroute Climb, Flaps Up: | |
| Normal, Sea Level..... | 75 - 85 KIAS |
| Normal, 10,000 Feet..... | 70 - 80 KIAS |
| Best Rate-of-Climb, Sea Level..... | 74 KIAS |
| Best Rate-of-Climb, 10,000 Feet..... | 72 KIAS |
| Best Angle-of-Climb, Sea Level..... | 62 KIAS |
| Best Angle-of-Climb, 10,000 Feet..... | 67 KIAS |
| Landing Approach: | |
| Normal Approach, Flaps Up..... | 65-75 KIAS |
| Normal Approach, Flaps 30°..... | 60-70 KIAS |
| Short Field Approach, Flaps 30°..... | 61 KIAS |
| Balked Landing: | |
| Maximum Power, Flaps 20°..... | 60 KIAS |
| Maximum Recommended Turbulent Air Penetration Speed: | |
| 2550 Lbs..... | 105 KIAS |
| 2200 Lbs..... | 95 KIAS |
| 1900 Lbs..... | 90 KIAS |
| Maximum Demonstrated Crosswind Velocity: | |
| Takeoff or Landing..... | 15 Knots |

CHECKLIST PROCEDURES

Note: Only the procedures shown below have changed from the checklist procedures for the original aircraft. Refer to the basic Flight Manual for the remainder of the steps not listed in this supplement.

PREFLIGHT INSPECTION

⑤ NOSE

2. Engine Oil Dipstick/Filler Cap - Check oil level, then check dipstick/filler cap SECURE. Do not operate with less than six quarts. Fill to eight quarts for extended flight.

TAKEOFF

NORMAL TAKEOFF

5. Climb Speed - 75 - 85 KIAS

FAA APPROVED

DATE: May 6, 2005

Pilot's Operating Handbook and FAA Approved Flight Manual Supplement for Cessna 172R

SHORT FIELD TAKEOFF

7. Climb Speed – 56 KIAS (until all obstacles are cleared)
8. Wing Flap – RETRACT slowly after reaching 75 KIAS

CRUISE

4. Power – 2100 – 2700 RPM (No more than 75% is recommended).

LANDING**SHORT FIELD LANDING**

3. Airspeed – 61 KIAS

BALKED LANDING

2. Climb Speed – 60 KIAS
3. Wing Flaps – 10° (until obstacles are cleared).
RETRACT (after reaching a safe altitude and 65 KIAS).

AMPLIFIED PROCEDURES**TAKEOFF****POWER CHECK**

It is important to check full throttle engine operation early in the takeoff roll. Any sign of rough engine operation or sluggish engine acceleration is good cause for discontinuing the takeoff. If this occurs, you are justified in making a thorough full throttle static runup before another takeoff is attempted. The engine should run smoothly and turn approximately 2300 – 2400 RPM with mixture leaned to provide maximum RPM.

WING FLAP SETTINGS

Normal takeoffs are accomplished with wing flaps 0° - 10°. Using 10° wing flaps reduces the ground roll and total distance over an obstacle by approximately 10 percent. Flap deflections greater than 10° are not approved for takeoff. If 10° wing flaps are used for takeoff, they should be left down until all obstacles are cleared and a safe flap retraction speed of 75 KIAS is reached. On a short field, 10° wing flaps and a obstacle clearance speed of 56 KIAS should be used.

FAA APPROVED

DATE: May 6, 2005

CRUISE
Normal cruise is performed between 45% and 75% rated power. The engine RPM and corresponding fuel consumption for various altitudes can be determined by using the data in Section 5.

| ALTITUDE | 75% POWER | | 65% POWER | | 55% POWER | |
|-----------|-----------|------|-----------|------|-----------|------|
| | KTAS | NMPG | KTAS | NMPG | KTAS | NMPG |
| Sea Level | 114 | 11.2 | 108 | 12.0 | 101 | 12.8 |
| 4000 feet | 119 | 11.7 | 112 | 12.4 | 104 | 13.2 |
| 8000 feet | 124 | 12.2 | 117 | 12.9 | 107 | 13.6 |

Figure 5
Cruise Performance Table

LANDING

SHORT FIELD LANDING
For a short field landing in smooth air conditions, make an approach at 61 KIAS with 30° flaps using enough power to control the glide path. (Slightly higher approach speeds should be used under turbulent air conditions.) After all approach obstacles are cleared, progressively reduce power and maintain the approach speed by lowering the nose of the airplane. Touchdown should be made with power off and on the main wheels first. Immediately after touchdown, lower the nose wheel and apply heavy braking as required. For maximum brake effectiveness, retract the flaps, hold the control wheel full back, and apply maximum brake pressure without sliding the tires.

NOISE CHARACTERISTICS

The certified noise level for the Model 172R at 160 HP at 2550 pounds maximum weight is 80.1 dB(A). No determination has been made by the Federal Aviation Administration that the noise levels of this airplane are or should be acceptable or unacceptable for operation at, into, or out of, any airport.

FAA APPROVED

DATE: May 6, 2005

SECTION 5
PERFORMANCE

| TABLE OF CONTENTS | PAGE |
|---|------|
| Figure 6, Airspeed Calibration – Normal Static Source..... | 18 |
| Figure 7, Airspeed Calibration – Alternate Static Source..... | 19 |
| Figure 8, Stall Speeds..... | 20 |
| Figure 9, Short Field Takeoff Distance, 2550 lbs..... | 21 |
| Figure 10, Short Field Takeoff Distance, 2400 lbs..... | 22 |
| Figure 11, Short Field Takeoff Distance, 2200 lbs..... | 23 |
| Figure 12, Maximum Rate-Of-Climb..... | 24 |
| Figure 13, Time, Fuel And Distance To Climb..... | 25 |
| Figure 14, Cruise Performance..... | 26 |
| Figure 15, Cruise Performance..... | 27 |
| Figure 16, Range Profile..... | 28 |
| Figure 17, Endurance Profile..... | 29 |
| Figure 18, Short Field Landing Distance..... | 30 |

FAA APPROVED

DATE: May 6, 2005

AIRPEED CALIBRATION

NORMAL STATIC SOURCE

CONDITION:

Power required for level flight or maximum power descent.

| | | | | | | | | | | | | | | | | |
|------------------|----|----|----|----|----|-----|-----|-----|-----|-----|-----|-----|--|--|--|--|
| FLAPS UP | | | | | | | | | | | | | | | | |
| KIAS | 50 | 60 | 70 | 80 | 90 | 100 | 110 | 120 | 130 | 140 | 150 | 160 | | | | |
| KCAS | 58 | 62 | 70 | 78 | 87 | 97 | 107 | 117 | 127 | 137 | 147 | 157 | | | | |
| FLAPS 10° | | | | | | | | | | | | | | | | |
| KIAS | 40 | 50 | 60 | 70 | 80 | 90 | 100 | 110 | | | | | | | | |
| KCAS | 51 | 57 | 63 | 71 | 80 | 89 | 99 | 109 | | | | | | | | |
| FLAPS 30° | | | | | | | | | | | | | | | | |
| KIAS | 40 | 50 | 60 | 70 | 80 | 95 | | | | | | | | | | |
| KCAS | 50 | 56 | 63 | 72 | 81 | 86 | | | | | | | | | | |

Figure 6
Airspeed Calibration - Normal

FAA APPROVED

DATE: May 8, 2005

AIRSPPEED CALIBRATION

ALTERNATE STATIC SOURCE

CONDITION:

Power required for level flight or maximum power descent.

| | | | | | | | | | | | | | | | | |
|------------------|----|----|----|----|----|-----|-------|-----|-------|-----|-----|-----|--|--|--|--|
| FLAPS UP | | | | | | | | | | | | | | | | |
| KIAS | 50 | 60 | 70 | 80 | 90 | 100 | 110 | 120 | 130 | 140 | 150 | 160 | | | | |
| KCAS | 56 | 62 | 68 | 76 | 85 | 95 | 105 | 115 | 125 | 134 | 144 | 154 | | | | |
| FLAPS 10° | | | | | | | | | | | | | | | | |
| KIAS | 40 | 50 | 60 | 70 | 80 | 90 | 100 | 110 | ----- | | | | | | | |
| KCAS | 51 | 55 | 60 | 68 | 77 | 86 | 96 | 105 | ----- | | | | | | | |
| FLAPS 30° | | | | | | | | | | | | | | | | |
| KIAS | 40 | 50 | 60 | 70 | 80 | 85 | ----- | | | | | | | | | |
| KCAS | 49 | 54 | 61 | 69 | 76 | 83 | ----- | | | | | | | | | |

NOTE:

Windows closed, ventilators closed, cabin heater, cabin air, and defroster on maximum.

Figure 7
Airspeed Calibration - Alternate

STALL SPEEDS AT 2550 POUNDS

Conditions:
Power On

MOST REARWARD CENTER OF GRAVITY

| FLAP SETTING | ANGLE OF BANK | | | | | | | |
|--------------|---------------|------|------|------|------|------|------|------|
| | 0° | | 30° | | 45° | | 60° | |
| | KIAS | KCAS | KIAS | KCAS | KIAS | KCAS | KIAS | KCAS |
| UP | 48 | 53 | 52 | 57 | 57 | 63 | 68 | 75 |
| 10° | 42 | 50 | 45 | 54 | 50 | 59 | 59 | 71 |
| 30° | 40 | 48 | 43 | 52 | 48 | 57 | 57 | 68 |

MOST FORWARD CENTER OF GRAVITY

| FLAP SETTING | ANGLE OF BANK | | | | | | | |
|--------------|---------------|------|------|------|------|------|------|------|
| | 0° | | 30° | | 45° | | 60° | |
| | KIAS | KCAS | KIAS | KCAS | KIAS | KCAS | KIAS | KCAS |
| UP | 48 | 53 | 52 | 57 | 57 | 63 | 68 | 75 |
| 10° | 43 | 51 | 46 | 55 | 51 | 61 | 61 | 72 |
| 30° | 40 | 48 | 43 | 52 | 48 | 57 | 57 | 68 |

NOTES:

1. Airframe loads during a stall recovery may be as much as 230 feet.
2. KIAS values are approximate.

Figure 8
Stall Speeds

FAA APPROVED

DATE: May 0, 2005

**SHORT FIELD TAKEOFF DISTANCE
AT 2550 POUNDS**

CONDITIONS:

Wing 10°
Full Throttle Prior to Brake Release
Paved, level, dry runway
Zero Wind
Lift Off: 51 KIAS
Speed at 50 Ft: 68 KIAS

| Press Alt In Feet | 0°C | | 10°C | | 20°C | | 30°C | | 40°C | |
|-------------------|--------------|------------------------------|--------------|------------------------------|--------------|------------------------------|--------------|------------------------------|--------------|------------------------------|
| | Grnd Roll Ft | Total Ft To Clear 50 Ft Obst | Grnd Roll Ft | Total Ft To Clear 50 Ft Obst | Grnd Roll Ft | Total Ft To Clear 50 Ft Obst | Grnd Roll Ft | Total Ft To Clear 50 Ft Obst | Grnd Roll Ft | Total Ft To Clear 50 Ft Obst |
| S. L. | 860 | 1465 | 925 | 1575 | 995 | 1690 | 1070 | 1810 | 1150 | 1945 |
| 1000 | 940 | 1600 | 1010 | 1720 | 1090 | 1850 | 1170 | 1990 | 1260 | 2135 |
| 2000 | 1025 | 1755 | 1110 | 1890 | 1195 | 2035 | 1285 | 2190 | 1380 | 2355 |
| 3000 | 1125 | 1925 | 1215 | 2080 | 1310 | 2240 | 1430 | 2420 | 1515 | 2605 |
| 4000 | 1235 | 2120 | 1335 | 2295 | 1440 | 2480 | 1550 | 2685 | 1660 | 2880 |
| 5000 | 1355 | 2345 | 1465 | 2545 | 1585 | 2755 | 1705 | 2975 | 1825 | 3205 |
| 6000 | 1495 | 2605 | 1615 | 2840 | 1745 | 3075 | 1875 | 3320 | 2010 | 3585 |
| 7000 | 1645 | 2910 | 1785 | 3170 | 1920 | 3440 | 2065 | 3730 | 2215 | 4045 |
| 8000 | 1820 | 3265 | 1970 | 3575 | 2120 | 3880 | 2280 | 4225 | 2450 | 4615 |

NOTES:

1. Short field technique as specified in Section 4.
2. Prior to takeoff from fields above 3000 feet elevation, the runway should be tapered to give maximum RPM in a full throttle, static runup.
3. Decrease distances 10% for each 8 knots headwind. For operation with tailwinds up to 10 knots, increase distances by 10% for each 2 knots.
4. For operation on dry, grass runway, increase distances by 15% of the "grnd roll" figure.

Figure 9
Short Field Takeoff Distance - 2550 lbs.

Pilot's Operating Handbook and FAA Approved Flight Manual Supplement for Cessna 172R

**SHORT FIELD TAKEOFF DISTANCE
AT 2400 POUNDS**

CONDITIONS:

Power 10"
Full Throttle Prior to Brake Release
Paved, level, dry runway
Zero Wind
J/R Oil: 48 KIAS
Speed at 60 Ft: 64 KIAS

| Press Alt In Feet | 0°C | | 10°C | | 20°C | | 30°C | | 40°C | |
|-------------------|--------------|------------------------------|--------------|------------------------------|--------------|------------------------------|--------------|------------------------------|--------------|------------------------------|
| | Grnd Roll Ft | Total Ft To Clear 50 Ft Obst | Grnd Roll Ft | Total Ft To Clear 50 Ft Obst | Grnd Roll Ft | Total Ft To Clear 50 Ft Obst | Grnd Roll Ft | Total Ft To Clear 50 Ft Obst | Grnd Roll Ft | Total Ft To Clear 50 Ft Obst |
| S.L. | 745 | 1275 | 800 | 1370 | 860 | 1470 | 925 | 1570 | 995 | 1685 |
| 1000 | 810 | 1390 | 875 | 1495 | 940 | 1605 | 1010 | 1720 | 1085 | 1845 |
| 2000 | 885 | 1520 | 955 | 1635 | 1030 | 1760 | 1110 | 1890 | 1190 | 2030 |
| 3000 | 970 | 1665 | 1050 | 1795 | 1130 | 1930 | 1215 | 2080 | 1305 | 2230 |
| 4000 | 1065 | 1830 | 1150 | 1975 | 1240 | 2130 | 1335 | 2295 | 1430 | 2455 |
| 5000 | 1170 | 2015 | 1265 | 2180 | 1360 | 2355 | 1465 | 2530 | 1570 | 2715 |
| 6000 | 1285 | 2230 | 1390 | 2410 | 1500 | 2610 | 1610 | 2805 | 1725 | 3015 |
| 7000 | 1415 | 2470 | 1530 | 2685 | 1650 | 2900 | 1770 | 3125 | 1900 | 3370 |
| 8000 | 1560 | 2755 | 1690 | 3000 | 1815 | 3240 | 1950 | 3500 | 2095 | 3790 |

NOTES:

- Short field technique as specified in Section 4.
- Prior to takeoff from fields above 3000 feet elevation, the mixture should be leaned to give maximum RPM at full throttle, static rpm.
- Decrease distances 10% for each 0 knots headwind. For operation with tail winds up to 10 knots, increase distances by 10% for each 2 knots.
- For operation on dry, grass runway, increase distances by 15% of the "ground roll" figure.

Figure 19
Short Field Takeoff Distance - 2400 lbs.

FAA APPROVED

DATE: May 6, 2005

Pilot's Operating Handbook and FAA Approved Flight Manual Supplement for Cessna 172R

**SHORT FIELD TAKEOFF DISTANCE
AT 2200 POUNDS**

CONDITIONS:

Flaps 10°
Full Throttle Prior to Brake Release
Paved, level, dry runway
Zero Wind
Lift Off: 44 KIAS
Speed at 50 Ft: 50 KIAS

| Press Alt In Feet | 0°C | | 10°C | | 20°C | | 30°C | | 40°C | |
|-------------------|--------------|------------------------------|--------------|------------------------------|--------------|------------------------------|--------------|------------------------------|--------------|------------------------------|
| | Grnd Roll Ft | Total Ft To Clear 50 Ft Obst | Grnd Roll Ft | Total Ft To Clear 50 Ft Obst | Grnd Roll Ft | Total Ft To Clear 50 Ft Obst | Grnd Roll Ft | Total Ft To Clear 50 Ft Obst | Grnd Roll Ft | Total Ft To Clear 50 Ft Obst |
| S.L. | 610 | 1055 | 655 | 1130 | 705 | 1205 | 760 | 1290 | 815 | 1380 |
| 1000 | 665 | 1145 | 720 | 1230 | 770 | 1315 | 830 | 1410 | 890 | 1505 |
| 2000 | 725 | 1250 | 785 | 1340 | 845 | 1435 | 905 | 1540 | 970 | 1650 |
| 3000 | 795 | 1365 | 860 | 1465 | 925 | 1570 | 995 | 1685 | 1065 | 1805 |
| 4000 | 870 | 1490 | 940 | 1605 | 1010 | 1725 | 1090 | 1855 | 1165 | 1975 |
| 5000 | 955 | 1635 | 1030 | 1765 | 1110 | 1900 | 1195 | 2035 | 1275 | 2175 |
| 6000 | 1050 | 1800 | 1130 | 1940 | 1220 | 2090 | 1310 | 2240 | 1400 | 2395 |
| 7000 | 1150 | 1985 | 1245 | 2145 | 1340 | 2305 | 1435 | 2475 | 1510 | 2650 |
| 8000 | 1270 | 2195 | 1370 | 2375 | 1475 | 2555 | 1580 | 2745 | 1685 | 2950 |

NOTES:

1. Short field technique as specified in Section 4.
2. Prior to takeoff from fields above 3000 feet elevation, the mixture should be leaned to give maximum RPM on full throttle, 2500 RPM.
3. Decrease distance 10% for each 9 knots headwind. For operation with tail winds up to 10 knots, increase distance by 10% for each 2 knots.
4. For operation on dry, grass runway, increase distance by 15% of the ground roll figure.

Figure 11
Short Field Takeoff Distance - 2200 lbs.

MAXIMUM RATE-OF-CLIMB AT 2550 POUNDS

CONDITIONS:

Flaps Up,
Full Throttle

| PRES. ALT FT | CLIMB SPEED KIAS | RATE OF CLIMB - FPM | | | |
|--------------------|------------------------|---------------------|-----|------|------|
| | | -20°C | 0°C | 20°C | 40°C |
| S.L. | 74 | 855 | 785 | 710 | 645 |
| 2000 | 73 | 760 | 695 | 625 | 560 |
| 4000 | 73 | 685 | 620 | 555 | 495 |
| 6000 | 73 | 575 | 515 | 450 | 390 |
| 8000 | 72 | 465 | 405 | 345 | 285 |
| 10,000 | 72 | 360 | 300 | 240 | 180 |
| 12,000 | 72 | 255 | 195 | 135 | --- |

NOTE:

- Mixture leaned above 3,000 feet for maximum RPM.

Figure 12
Maximum Rate of Climb

FAA APPROVED

DATE: May 6, 2005

**TIME, FUEL AND DISTANCE TO CLIMB
AT 2550 POUNDS**

CONDITIONS:

Flaps Up
Full Throttle
Standard Temperature

| PRESS ALT FT | CLIMB SPEED KIAS | RATE OF CLIMB FPM | FROM SEA LEVEL | | |
|--------------------|------------------------|----------------------------|-------------------|---------------------|------------|
| | | | TIME IN MIN | FUEL USED GAL | DIST NM |
| S.L. | 74 | 730 | 0 | 0.0 | 0 |
| 1000 | 73 | 695 | 1 | 0.4 | 2 |
| 2000 | 73 | 655 | 3 | 0.8 | 4 |
| 3000 | 73 | 620 | 4 | 1.2 | 6 |
| 4000 | 73 | 600 | 6 | 1.5 | 8 |
| 5000 | 73 | 550 | 8 | 1.9 | 10 |
| 6000 | 73 | 505 | 10 | 2.2 | 13 |
| 7000 | 73 | 455 | 12 | 2.6 | 16 |
| 8000 | 72 | 410 | 14 | 3.0 | 19 |
| 9000 | 72 | 360 | 17 | 3.4 | 22 |
| 10,000 | 72 | 315 | 20 | 3.9 | 27 |
| 11,000 | 72 | 265 | 24 | 4.4 | 32 |
| 12,000 | 72 | 220 | 28 | 5.0 | 38 |

NOTES:

1. Add 1.4 gallons of fuel for engine start, taxi and takeoff allowance.
2. Mixture required above 3,000 feet for maximum RPM.
3. Increase time, fuel and distance by 10% for each 10°C above standard temperature.
4. Distances shown are based on zero wind.

Figure 13
Time, Fuel and Distance to Climb

FAA APPROVED

DATE: May 6, 2005

Pilot's Operating Handbook and FAA Approved Flight Manual Supplement for Cessna 172R

CRUISE PERFORMANCE

CONDITIONS:
2500 Pounds
Recommended Lean Mixture At All Altitudes (Refer to Section 4, Cruise)

| PRESS ALT FT | RPM | 20°C BELOW STANDARD TEMP | | | STANDARD TEMPERATURE | | | 20°C ABOVE STANDARD TEMP | | |
|--------------|------|--------------------------|------|------|----------------------|------|------|--------------------------|------|-----|
| | | % RHP | KTAS | GPH | % DHP | KTAS | GPH | % RHP | KTAS | GPH |
| 2000 | 2500 | 83 | 117 | 11.1 | 77 | 118 | 10.5 | 72 | 117 | 9.9 |
| | 2500 | 78 | 115 | 10.6 | 73 | 115 | 9.9 | 68 | 115 | 9.4 |
| | 2400 | 69 | 111 | 9.6 | 64 | 110 | 9.0 | 60 | 109 | 8.5 |
| | 2300 | 61 | 105 | 8.6 | 57 | 104 | 8.1 | 53 | 102 | 7.7 |
| | 2200 | 53 | 99 | 7.7 | 50 | 97 | 7.3 | 47 | 95 | 6.9 |
| | 2100 | 47 | 92 | 6.9 | 44 | 90 | 6.6 | 42 | 89 | 6.3 |
| 4000 | 2600 | 83 | 120 | 11.1 | 77 | 120 | 10.4 | 72 | 119 | 9.8 |
| | 2550 | 79 | 118 | 10.6 | 73 | 117 | 9.9 | 68 | 117 | 9.4 |
| | 2500 | 74 | 115 | 10.1 | 69 | 115 | 9.5 | 64 | 114 | 8.9 |
| | 2400 | 65 | 110 | 9.1 | 61 | 109 | 8.5 | 57 | 107 | 8.1 |
| | 2300 | 58 | 104 | 8.2 | 54 | 102 | 7.7 | 51 | 101 | 7.3 |
| | 2200 | 51 | 98 | 7.4 | 48 | 96 | 7.0 | 45 | 94 | 6.7 |
| 6000 | 2650 | 83 | 122 | 11.1 | 77 | 122 | 10.4 | 72 | 121 | 9.8 |
| | 2600 | 74 | 120 | 10.6 | 73 | 119 | 9.9 | 68 | 119 | 9.4 |
| | 2500 | 70 | 115 | 9.6 | 65 | 114 | 9.0 | 60 | 112 | 8.5 |
| | 2400 | 62 | 109 | 8.6 | 57 | 108 | 8.2 | 54 | 106 | 7.7 |
| | 2300 | 54 | 103 | 7.8 | 51 | 101 | 7.4 | 48 | 99 | 7.0 |
| | 2200 | 48 | 96 | 7.1 | 45 | 94 | 6.7 | 43 | 92 | 6.4 |

NOTE:

1. Cruise speeds are shown for an airplane equipped with speed fittings. Without speed fittings, decrease speeds shown by 2 knots.

Figure 14
Cruise Performance

FAA APPROVED

DATE: May 6, 2006

CRUISE PERFORMANCE

CONDITIONS:
2550 Pounds
Recommended Lean Mixture At All Altitudes (Refer to Section 4,
Cruise)

| PRESS ALT FT | RPM | 20°C BELOW STANDARD TEMP | | | STANDARD TEMPERATURE | | | 20°C ABOVE STANDARD TEMP | | |
|--------------------|------|-----------------------------|------|------|-------------------------|------|------|-----------------------------|------|-----|
| | | % BHP | KTAS | GPH | % BHP | KTAS | GPH | % BHP | KTAS | GPH |
| 8000 | 2700 | 83 | 125 | 11.3 | 77 | 124 | 10.4 | 71 | 123 | 9.7 |
| | 2650 | 78 | 122 | 10.5 | 72 | 122 | 9.8 | 67 | 120 | 9.3 |
| | 2600 | 74 | 120 | 10.0 | 68 | 119 | 9.4 | 64 | 117 | 8.9 |
| | 2500 | 65 | 114 | 9.1 | 61 | 112 | 8.6 | 57 | 113 | 8.1 |
| | 2400 | 58 | 108 | 8.2 | 54 | 106 | 7.8 | 51 | 104 | 7.4 |
| | 2300 | 52 | 101 | 7.5 | 48 | 99 | 7.1 | 46 | 97 | 6.8 |
| | 2200 | 46 | 94 | 6.8 | 43 | 92 | 6.5 | 41 | 90 | 6.2 |
| 10,000 | 2780 | 78 | 124 | 10.5 | 72 | 123 | 9.8 | 67 | 122 | 9.3 |
| | 2650 | 73 | 122 | 10.0 | 68 | 120 | 9.4 | 63 | 119 | 8.9 |
| | 2600 | 69 | 119 | 9.5 | 64 | 117 | 9.0 | 60 | 115 | 8.5 |
| | 2500 | 62 | 113 | 8.7 | 57 | 111 | 8.2 | 54 | 109 | 7.8 |
| | 2400 | 55 | 106 | 7.9 | 51 | 104 | 7.5 | 49 | 102 | 7.1 |
| | 2360 | 49 | 100 | 7.2 | 46 | 97 | 6.8 | 44 | 95 | 6.5 |
| 12,000 | 2650 | 69 | 121 | 9.5 | 64 | 119 | 8.9 | 60 | 117 | 8.5 |
| | 2600 | 65 | 118 | 9.1 | 61 | 116 | 8.5 | 57 | 114 | 8.1 |
| | 2500 | 58 | 111 | 8.3 | 54 | 109 | 7.8 | 51 | 107 | 7.4 |
| | 2400 | 52 | 105 | 7.5 | 49 | 102 | 7.1 | 46 | 100 | 6.8 |
| | 2360 | 47 | 98 | 6.9 | 44 | 95 | 6.6 | 41 | 92 | 6.3 |

NOTE:
1. Cruise speeds are shown for an airplane equipped with speed fairings.
Without speed fairings, decrease speeds shown by 2 knts.

Figure 15
Cruise Performance

Pilot's Operating Handbook and FAA Approved Flight Manual Supplement for Cessna 172R

RANGE PROFILE
45 MINUTES RESERVE
#3 GALLONS USABLE FUEL

CONDITIONS:
2850 Feet
Best Mixture
Lean Mixture for Cruise At All Altitudes
Standard Temperature
Zero Wind

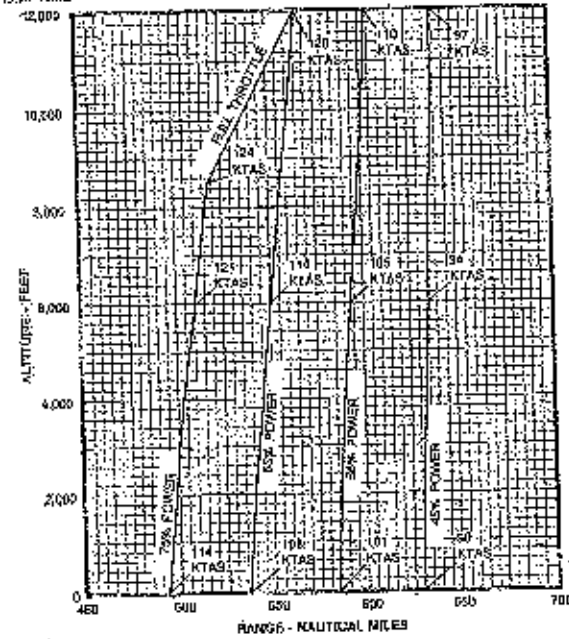

NOTE:
1. This chart allows for the fuel used for engine start, taxi, takeoff and climb, and the distance during climb.
2. Performance is shown for an airplane equipped with speed fittings, which increase the cruise speeds by approximately 2 knots.

Figure 16
Range Profile

FAA APPROVED

DATE: May 8, 2005

Pilot's Operating Handbook and FAA Approved Flight Manual Supplement for Cessna 172R

ENDURANCE PROFILE
45 MINUTES RESERVE
63 GALLONS USABLE FUEL

CONDITIONS:
2050 Pounds
Recommended LSA Mixture for Cruise At All Altitudes
Standard Temperature

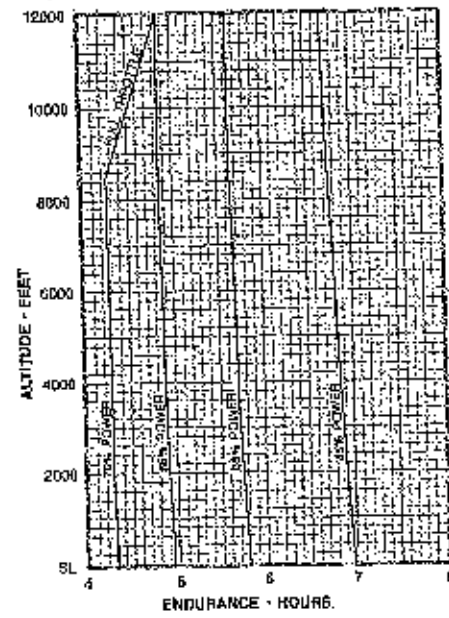

NOTE:
1. This chart allows for the fuel used for engine start, taxi, takeoff and climb, and the time during descent.

Figure 17
Endurance Profile

FAA APPROVED
DATE: May 6, 2005

**SHORT FIELD LANDING DISTANCE
AT 2550 POUNDS**

CONDITIONS:

Flaps 30°
Power Off
Maximum Braking
Level, level, dry runway
25° Wind
Speed at 50 Ft: 61 KIAS

| Press Alt In Feet | 0°C | | 10°C | | 20°C | | 30°C | | 40°C | |
|-------------------|--------------|------------------------------|--------------|------------------------------|--------------|------------------------------|--------------|------------------------------|--------------|------------------------------|
| | Grnd Roll Ft | Total Ft To Clear 50 Ft Obst | Grnd Roll Ft | Total Ft To Clear 50 Ft Obst | Grnd Roll Ft | Total Ft To Clear 50 Ft Obst | Grnd Roll Ft | Total Ft To Clear 50 Ft Obst | Grnd Roll Ft | Total Ft To Clear 50 Ft Obst |
| S.L. | 545 | 1290 | 565 | 1320 | 585 | 1350 | 605 | 1380 | 625 | 1415 |
| 1000 | 565 | 1320 | 585 | 1350 | 605 | 1385 | 625 | 1420 | 640 | 1450 |
| 2000 | 585 | 1355 | 610 | 1385 | 630 | 1420 | 650 | 1455 | 670 | 1490 |
| 3000 | 610 | 1395 | 630 | 1425 | 655 | 1460 | 675 | 1495 | 695 | 1530 |
| 4000 | 630 | 1425 | 655 | 1460 | 675 | 1495 | 700 | 1535 | 725 | 1570 |
| 5000 | 655 | 1460 | 680 | 1500 | 705 | 1535 | 725 | 1575 | 750 | 1615 |
| 6000 | 680 | 1500 | 705 | 1540 | 730 | 1580 | 755 | 1620 | 780 | 1660 |
| 7000 | 705 | 1545 | 730 | 1585 | 760 | 1625 | 785 | 1665 | 810 | 1705 |
| 8000 | 735 | 1585 | 760 | 1630 | 790 | 1670 | 815 | 1715 | 840 | 1755 |

NOTES:

- Short field technique as specified in Section 4.
- Decrease distances 10% for each 8 knots headwind. For operation with tail wind up to 10 knots, increase distances by 10% for each 2 knots.
- For operation on dry, grass runway, increase distances by 45% of the "ground roll" figure.
- If landing with flaps up, increase the approach speed by 9 KIAS and allow for 35% longer distances.

Figure 18
Short Field Landing Distance

FAA APPROVED

DATE: May 6, 2005



351 Airway Dr. Decatur, TX 75224

AFMS No.: 09001-3
Rev.: IR
Page: 31 of 36

Pilot's Operating Handbook and FAA Approved Flight Manual Supplement for Cessna 172R

SECTION 6
WEIGHT & BALANCE/EQUIPMENT LIST

| TABLE OF CONTENTS | PAGE |
|---|-------------|
| Figure 19, Center of Gravity Moment Envelope..... | 32 |
| Figure 20, Center of Gravity Limits..... | 33 |
| Comprehensive Equipment List..... | 34 |

FAA APPROVED

DATE: May 6, 2005

Pilot's Operating Handbook and FAA Approved Flight Manual Supplement for Cessna 172R

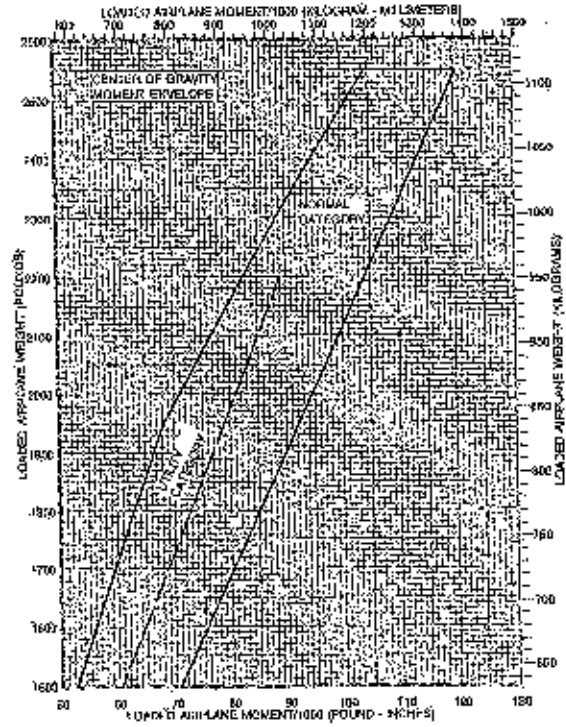

Figure 19
Center of Gravity Moment Envelope

FAA APPROVED
DATE: May 6, 2005

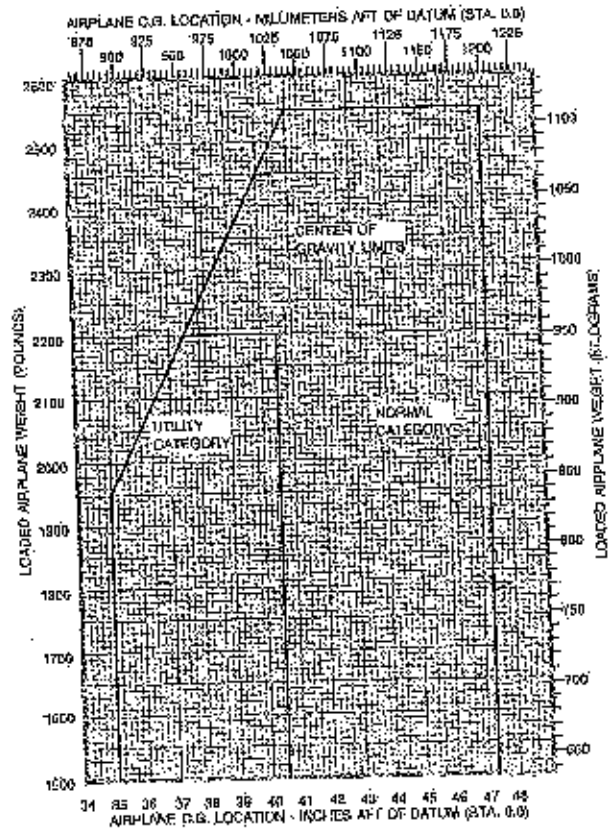

Figure 20
Center of Gravity Limits

FAA APPROVED
DATE: May 8, 2005



591 AIRPORT DR. CASSEL, TX 76234

AFMS No.: 99001-3
Rev.: IR
Page: 34 of 36

Pilot's Operating Handbook and FAA Approved Flight Manual Supplement for Cessna 172R

COMPREHENSIVE EQUIPMENT LIST

| ITEM No. | EQUIPMENT LIST DESCRIPTION | REF PART NO. | WT LBS | ARM INCHES |
|----------|-------------------------------------|----------------|--------|------------|
| 32-01-R | WHEEL BRAKE AND TIRE, 6.00 X 8 MAIN | | 36.2* | 57.8* |
| | - WHEEL ASSY, CLEVELAND (EACH) | C183001-0104 | 6.2 | 58.2 |
| | - BRAKE ASSY, CLEVELAND (EACH) | C183030-0111 | 1.8 | 54.6 |
| | - TIRE, 6-PLY BLACKWALL (EACH) | 6.00-6, 6-PLY | 8.0 | 58.2 |
| | - TUBE (EACH) | | 2.1 | 58.2 |
| 34-01-R | INDICATOR, AIRSPEED | S3325-6 | 0.6 | 16.2 |
| 61-01-R | PROPELLER ASSY, FIXED-PITCH | | 36.8* | -36.2* |
| | - PROPELLER, 78" McCADLEY | 1A170E/JHA7060 | 35.0 | -36.4 |
| | - PROP SPACER ADAPTER, 3.5" | G7726 | 3.6 | -36.0 |
| 79-01-S | EGT/FUEL FLOW | S3277-B | 0.8 | 7.8 |
| 77-01-R | TACHOMETER, RECORDING | S3320-5 | 1.0 | 12.1 |

FAA APPROVED

DATE: May 6, 2005



351 Airport Dr., Decatur, TX 78834

AFMS No.: 99001-3
Rev.: 1R
Page: 35 of 38

Pilot's Operating Handbook and FAA Approved Flight Manual Supplement for Cessna 172R

**SECTION 7
AIRPLANE AND SYSTEMS DESCRIPTION**

| TABLE OF CONTENTS | PAGE |
|-------------------------|------|
| Engine..... | 36 |
| Engine Instruments..... | 38 |
| Propeller..... | 38 |

FAA APPROVED

DATE: May 8, 2005



851 Airport Dr. DECATUR, TX 76924

AFMS No.: 89001-3
Rev.: 1R
Page: 36 of 36

Pilot's Operating Handbook and FAA Approved Flight Manual Supplement for Cessna 172R

ENGINE

ENGINE INSTRUMENTS

The engine driven mechanical tachometer is located on the instrument panel to the right of the pilot's control wheel. The instrument is calibrated in increments of 100 RPM and indicates both engine and propeller speed. An hour meter in the lower section of the dial records elapsed engine time in hours and tenths. Instrument markings include the normal operating range (multiple width green arc) of 2100 to 2700 RPM, and a maximum (red line) of 2700 RPM. The multiple width green arc has steps at 2500, 2600, and 2700 RPM which indicate the maximum recommended power settings for altitudes of sea level, 5,000 and 10,000 feet respectively.

PROPELLER

The airplane is equipped with a two-bladed, fixed-pitch, one-piece forged aluminum alloy propeller which is anodized to retard corrosion. The propeller is 78 inches in diameter.

FAA APPROVED

DATE: May 6, 2005

Garmin International, Inc.
1200 E. 151st Street
Olathe, Kansas 66062 U.S.A.

FAA APPROVED

AIRPLANE FLIGHT MANUAL SUPPLEMENT
or
SUPPLEMENTAL AIRPLANE FLIGHT MANUAL

for the
Garmin GPS 175/GNX 375/GNC 355 GPS/XPDR/COM Navigation System

as installed in
Cessna 172R / \$
Make and Model Airplane

Registration Number: N71255 Serial Number: 17280800

This document serves as an Airplane Flight Manual Supplement or as a Supplemental Airplane Flight Manual when the aircraft is equipped in accordance with Supplemental Type Certificate SA02636SE for the installation and operation of the Garmin GPS 175, GNC 355, or GNX 375 GPS/COM/XPDR Navigation System. This document must be incorporated into the FAA Approved Airplane Flight Manual or provided as an FAA Approved Supplemental Airplane Flight Manual.

The information contained herein supplements the information in the FAA Approved Airplane Flight Manual. For limitations, procedures, loadings and performance information not contained in this document, refer to the FAA Approved Airplane Flight Manual, markings, or placards.

FAA Approved by: JR Brownell

JR Brownell
ODA STC Unit Administrator
Garmin International, Inc.
CDA-240087-CE

Date: 3/3/2020

AFMS, Garmin GPS/GNC/GNX System
FAA APPROVED

LOG OF REVISIONS

| Revision Number | Date | Page Number | Description | I/A-A Approved |
|-----------------|----------|---|---|--|
| 1 | 03/22/19 | All | Complete Supplement | <p><i>IR Brewster</i> ODA STC Unit Administrator Garmin International, Inc. ODA-240087-CE Date: <u>03/22/2019</u></p> |
| 2 | 07/25/19 | Through out Page 20 Page 34 Page 36 Page 37 | <p>Added information for GNC 355.</p> <p>Updated Software Versions</p> <p>Removed Narco 4 and 5 indicators.</p> <p>Updated Pilot Guide references</p> <p>Added circuit breaker label for GNC 355</p> | <p><i>IR Brewster</i> ODA STC Unit Administrator Garmin International, Inc. ODA-240087-CE Date: <u>07/25/2019</u></p> |
| 3 | 03/03/20 | Page 3 Page 19 Page 21 Page 25 Page 37 Page 46 | <p>Added new FIS-B Weather Products</p> <p>Updated RAIM check wording.</p> <p>Updated software versions table</p> <p>Added Database Sync Exception to Database Updates</p> <p>Updated revision of Pilot's Guide</p> <p>Added Database Sync Discussion</p> | <p><i>IR Brewster</i> ODA STC Unit Administrator Garmin International, Inc. ODA-240087-CE Date: <u>03/03/2020</u></p> |



To/From Indication

Figure 6 - To/From Indication Location

7.22 Database Sync Compatibility

The GPS 175/GNC 355/GNX 375 units are capable of utilizing database sync completely between other GPS 175/GNC 355/GNX 375 units, as well as G1275 units. The GPS 175/GNC 355/GNX 375 are capable of a limited database sync from a G500 TXi and G600 TXi. Sync from the GPS 175/GNC 355/GNX 375 to the G500 TXi and G600 TXi is not supported.

| SECTION | PAGE |
|--|-----------|
| Section 1. General | 1 |
| 1.1 Garmin GPS 175/GNC 355/GNX 375 Navigators | 1 |
| 1.2 System Capabilities | 5 |
| 1.3 GENSS (GPS/SBAS) Navigation system Equipment approvals | 5 |
| 1.4 Definitions | 15 |
| Section 2. LIMITATIONS | 17 |
| 2.1 Kinds of Operation | 17 |
| 2.2 Minimum Equipment | 17 |
| 2.3 ADS-B Out | 18 |
| 2.4 Pressure Altitude Broadcast Inhibit (PABI) | 18 |
| 2.5 Flight Planning | 19 |
| 2.6 System Use | 20 |
| 2.7 Applicable System Software | 21 |
| 2.8 Navigation Database | 21 |
| 2.9 Ground Operations | 21 |
| 2.10 Instrument Approaches | 22 |
| 2.11 RF Legs | 23 |
| 2.12 Autopilot Coupling | 23 |
| 2.13 Terrain Alerting Function | 24 |
| 2.14 Polar Operations | 24 |
| 2.15 ADS-B Weather (Optional for GPS 175/GNC355) | 24 |
| 2.16 Traffic Display (Optional for GPS 175/GNC355) | 24 |
| 2.17 Flight Planner/Calculator Functions | 25 |
| 2.18 Glove Use / Covered Fingers | 25 |
| 2.19 Demo Mode | 25 |
| 2.20 Wire Obstacle Database | 25 |
| 2.21 Portable Electronic Devices | 25 |
| 2.22 Database Updates | 25 |
| 2.23 OBS Mode | 25 |
| 2.24 Advisory Visual Approaches | 25 |
| 2.25 Placards | 26 |
| Section 3. EMERGENCY PROCEDURES | 27 |
| 3.1 Emergency Procedures | 28 |
| 3.2 Abnormal Procedures | 31 |
| Section 4. NORMAL PROCEDURES | 31 |
| 4.1 Unit Power On | 31 |
| 4.2 Before Takeoff | 32 |
| 4.3 HSI and EHSI Operation | 32 |
| 4.4 Autopilot Operation | 34 |
| 4.5 Coupling the Autopilot during approaches | 34 |
| 4.6 Composite Indicators | 35 |

| | |
|--|----|
| Section 5. PERFORMANCE | 36 |
| Section 6. WEIGHT AND BALANCE | 36 |
| Section 7. SYSTEM DESCRIPTIONS | 37 |
| 7.1 Pilot's Guide | 37 |
| 7.2 Leg Sequencing | 37 |
| 7.3 Terrain Alerting | 37 |
| 7.4 Traffic System (Optional for GPS 175/GNC355) | 38 |
| 7.5 Power | 38 |
| 7.6 Databases and Flight Plan Waypoints/Procedures | 39 |
| 7.7 External Switches | 39 |
| 7.8 Airspace Depiction and Alerts | 40 |
| 7.9 ADS-B Traffic (Optional for GPS 175/GNC355) | 41 |
| 7.10 Transponder Control (GNX 375 Only) | 42 |
| 7.11 Depiction of Obstacles and Wires | 42 |
| 7.12 Flight Stream 510 (Optional) | 43 |
| 7.13 Built in Blueooth | 43 |
| 7.14 Map Page | 43 |
| 7.15 Flight Plan Depiction | 44 |
| 7.16 User Defined Waypoints | 44 |
| 7.17 Times and Distances | 44 |
| 7.18 Direct-To Operations | 44 |
| 7.19 European Visual Reporting Points | 44 |
| 7.20 Advisory Visual Approaches | 45 |
| 7.21 Composite CDIs | 45 |

7.20 Advisory Visual Approaches

The GPS 175/GNC 355/GNX 375 will provide advisory visual approaches to many runways in the aviation database. Lateral guidance for the visual approach is aligned with the runway bearing. Vertical guidance is provided for those runways with VGS1 information for distances up to 4.0NM from the runway. If a terrain database is installed in the GPS 175/GNC 355/GNX 375, the GPS 175/GNC 355/GNX 375 provides vertical guidance up to 28NM from the runway end unless the computed glide slope would impact terrain or obstacles from the database. If the projected impact point is under 28NM and greater than 4NM, the flight plan line for the approach is shortened to indicate where vertical guidance is active for the approach. If the terrain impact point is less than 4NM from the runway and there is no VGS1 data available, vertical guidance is not provided for that approach. Lateral guidance is still available when vertical guidance is removed.

CDI and VDI indications are equivalent to those of other GPS-based approaches (e.g. LPV or LNAV+V). The GPS 175/GNC 355/GNX 375 annunciates "VISUAL" in the annunciator bar to indicate a visual approach is active.

When loading, or activating the approach, the GPA and TCH information for that approach will be displayed on a popup. If there is no vertical guidance available, the popup will display "(NO VERTICAL GUIDANCE)".

Visual approaches are intended to be used as an aid to situational awareness. Visual approaches are advisory in nature and do not guarantee terrain and obstacle clearance for the approach runway.

7.21 Composite CDIs

When the GPS 175/GNC 355/GNX 375 is interfaced to a composite CDI indicator, the TO/From Flag will not function on the indicator, and a placard must be installed adjacent to the indicator. The placard must read: "TO/FROM FLAG WILL NOT FUNCTION CORRECTLY WHEN DISPLAYING GPS DEVIATION USE TO/FROM INDICATION ON GPS." and follow all placard guidelines in the Installation Manual.

These indicators will either show no To/From indication at all, or will only show the "TO" indication. Pilots must use the on screen TO/FROM indications when interfaced to these CDIs.

7.14 Map Page

7.14.1 Configuration

The moving map and weather pages are capable of displaying a large quantity and variety of data. Map data is layered to ensure that data which is typically more critical is drawn above less critical data, however at some zoom scales and configurations the map may be cluttered with large amounts of data. Controls are provided on the Map and Weather pages for the pilot to select which data is displayed, the declutter level, and the zoom scales at which data is added to or removed from the display. It is the responsibility of the pilot to select settings for the map page that will provide the display of data most appropriate to the operation being conducted.

7.15 Flight Plan Depiction

The map page depicts the current active flight plan. When an off-route Direct To is active the flight plan will no longer be depicted on the map.

7.16 User Defined Waypoints

When a User Defined Waypoint is created, a default name will automatically be provided, and the pilot is given the option to enter a different name for the waypoint. Pages which have the autofill function will prevent some waypoint names from being used. If it is desired to name the waypoint with a subset of the name of an existing waypoint in the database then this must be accomplished on the Waypoint Info / User Waypoints page.

7.17 Times and Distances

Time and Distance data to the next waypoint is always calculated from the present position to that waypoint and does not account for the path which may be flown (such as intercepting a course) to reach the waypoint.

When navigating using GPS guidance most legs are TO type legs where distance to the next waypoint decreases along the route. However, some procedures include FROM type legs. When navigating on a leg that is a FROM leg indications that it is a FROM leg include the TO:FROM flag indicating FROM and distances increasing in distance fields.

7.18 Direct-To Operations

When conducting Direct-To operations the Flight Plan tab provides a list of waypoints in the flight plan for which Direct-To is available. Some entries in the flight plan such as Holds and Course Reversals are not eligible for Direct-To and the pilot must instead select the associated waypoint if Direct-To operation is desired.

7.19 European Visual Reporting Points

If the GPS 175/GNC 355/GNX 375 is interfaced with a G500/600 PFD/MFD, and a flight plan in the GPS 175/GNC 355/GNX 375 contains a VRP, the G500/600 must have a database that contains the VRP in order to appropriately display the VRP on the MFD map. If the database on the PFD/MFD does not contain the VRP, the VRP will display on the MFD map as an intersection.

Section 1. General

1.1 Garmin GPS 175/GNC 355/GNX 375 Navigators
The Garmin GPS 175/GNC 355/GNX 375 navigation system is a GPS system with a Satellite Based Augmentation System (SBAS) and optional transponder, comprised of a Garmin TSO-C146e navigator and a Garmin approved GPS/SBAS antenna(s). The GPS 175/GNC 355/GNX 375 navigation system is installed in accordance with AC 20-138D.

The GNX 375 also contains an ADS-B In/Out transponder capable of 1090ES out and UAT/1090 In. The transponder is a radio transmitter/receiver that operates on radar frequencies, receiving ground radar or TCAS interrogations at 1030 MHz and transmitting a coded response of pulses to ground-based radar on a frequency of 1090 MHz. Each unit is equipped with IDENT capability to initiate the SPI (special position identification) pulse for 18 seconds and will reply to AICRBS Mode A, Mode C, and Mode S All-Call interrogation.

The GNC 355(A) is a GPS 175 with an integrated com radio with either 8.33 or 25 kHz spacing.

| | GPS 175 | GNC 355 | GNC 355A | GNX 375 |
|--|---------|---------|----------|---------|
| GPS SBAS Navigation: <ul style="list-style-type: none">Oceanic, enroute, terminal, and non-precision approach guidancePrecision approach guidance (LP, LPV) | X | X | X | X |
| Moving map including topographic, terrain, aviation, and geopolitical data | X | X | X | X |
| Display of FIS-B weather products (optional for GPS 175 / GNC 355) | X | X | X | X |
| Display of ADS-B traffic data (optional for GPS 175 / GNC 355) | X | X | X | X |
| Built in transponder with 1090ES out, and 1090/UAT In | X | X | X | X |
| Visual Terrain Alerting | X | X | X | X |
| Supplemental calculators and timers | X | X | X | X |
| Control of Flight Stream 510 (optional) | X | X | X | X |
| 25 kHz Com Radio | | X | | |
| 8.33 kHz Com Radio | | | X | |

Table 1 -- GPS 175/GNC 355/GNX 375 Functions

The GPS navigation functions and optional transponder and navigation radio functions are operated by dedicated hard keys, a dual concentric rotary knob, or the touchscreen.

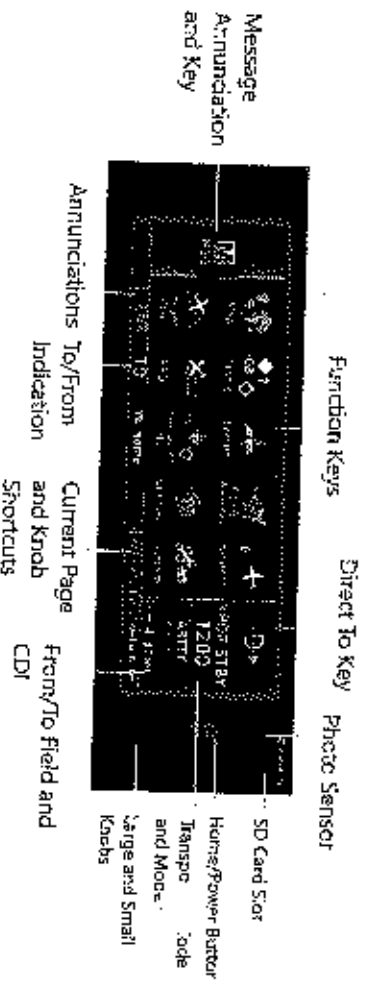

Figure 1 - GNX 375 Control and Display Layout

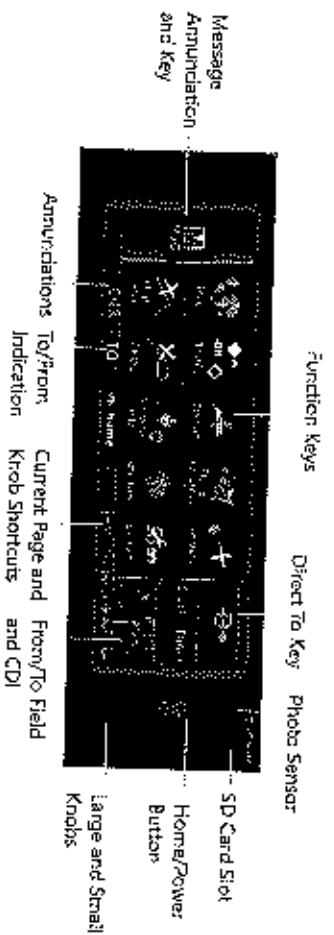

Figure 2 - GPS 175 Control and Display Layout



Figure 3 - GNC 355 Display Layout



Figure 5 - Obstacle Overlay Icon (Left), Wire Overlay Icon (Right)

7.12 Flight Stream 510 (Optional)

The Flight Stream 510 is mounted in the GPS 175/GNC 355/GNX 375 SD card slot and includes a Wi-Fi transmitter. The Flight Stream product line uses a wireless transmitter to allow databases to be loaded onto the GPS 175/GNC 355/GNX 375 from a personal electronic devices (PEDs). Limitations regarding database operations are found in Section 2.22.

Garmin provides a list of tested and compatible devices that can be used with the Flight Stream. Connection to the Flight Stream may be possible with devices other than those on the supported device list, but Wi-Fi stability and wireless data integrity cannot be guaranteed.

For details about the Garmin supported devices and apps for use with the Flight Stream product line, please visit: http://www.garmin.com/connections/supported_devices

7.13 Built in Bluetooth

The GPS 175/GNC 355/GNX 375 have built in Bluetooth transceivers to allow PEDs to connect to the certified avionics. Data such as traffic, flight plan, datalink weather, and altitude information is sent from the GPS 175/GNC 355/GNX 375 to the PED. The PED is capable of sending flight plans to the GPS 175/GNC 355/GNX 375.

Garmin provides a list of tested and compatible devices that can be used with the GPS 175/GNC 355/GNX 375. Connection to the GPS 175/GNC 355/GNX 375 may be possible with devices other than those on the supported device list, but Bluetooth® stability and wireless data integrity cannot be guaranteed.

For details about the Garmin supported devices and apps for use with GPS 175/GNC 355/GNX 375 product line, please visit: http://www.garmin.com/connections/supported_devices

7.10 Transponder Control (GNX 375 Only)

The GNX 375 has a built in transponder with on screen controls for squawk code, mode, and additional transponder functions. The transponder is a 1090ES out, and 1090/UAT In device.

7.11 Depiction of Obstacles and Wires

7.11.1 Dedicated Terrain Page

The dedicated Terrain page will always depict point obstacles at zoom scales of 10 nm or less and depict wire obstacles at zoom scales of 5 nm or less. The obstacle or wire overlay icon (see Figure 4) will be shown near the bottom of the display when the obstacle or wire depiction is active based on the zoom scale.

NOTE

Only obstacles and wires within 2,000 feet vertically of the aircraft will be drawn on the Terrain page. It is therefore possible to have an obstacle or wire overlay icon displayed with no obstacles or wires being depicted on the display.



Figure 4 – Obstacle Overlay Icon (Left), Wire Overlay Icon (Right)

7.11.2 Map Page

The Map page may be configured to depict point obstacles and wire obstacles at various zoom scales by the pilot by using the Map page menu. The obstacle or wire overlay icon (see Figure 5) will be shown near the bottom of the display when the obstacle or wire overlay is active based on the current zoom scale and setting selected by the pilot.

The settings chosen by the pilot on the Map page menu (including obstacle and wire display ranges) are saved over a power cycle.

NOTE

Only obstacles and wires within 2,000 feet vertically of the aircraft will be drawn on the Map page. It is therefore possible to have an obstacle or wire overlay icon displayed with no obstacles or wires being depicted on the display.

NOTE

The Map page may be configured by the pilot to not show any obstacles or wires at any zoom scale.

The GNX 375 transponder transmits ADS-B Out data on 1090 extended squitter (1090 MHz). It integrates data from internal and external sources to transmit the following data per 14 CFR 91.227:

- GPS Position, Altitude, and Position Integrity
- Ground Track and/or Heading, Ground Speed, and Velocity Integrity
- Air Ground Status
- Flight ID, Call Sign, ICAO Registration Number
- Capability and Status Information
- Transponder Squawk Codes between 0000-7777.
- Emergency Status
- IDENT - initiates SPI (special position identification) pulse for 18 seconds

The transponder also receives ADS-B In data on 1090 MHz, including ADS-B and ADS-R Data. ADS-B is data directly from another transmitting aircraft, and the ADS-R data which is rebroadcast ADS-B data from a ground station. The transponder also includes ADS-B In data on UAT (978 MHz). UAT In data includes ADS-B, ADS-R, TIS-B, and FIS-B data. TIS-B Data is a broadcast of secondary surveillance radar (SSR) derived traffic information from ground stations, and FIS-B data is broadcast of aviation data from a ground station. FIS-B data includes the following products:

- Graphical and textual weather products
 - NEXRAD
 - PIREPs
 - G ARMETs
 - METARs
 - TAFs
 - Winds Aloft
 - Lightning
 - Icing
 - Turbulence
 - Center Weather Advisories
- Aviation Data
 - TFRs
 - NOTAMS

The transponder provides ADS-B traffic information and alerting to the pilot. The

alerting icon, aural and visual traffic alerting information on the display, as well as on interfaced displays where supported.

7.9 ADS-B Traffic (Optional for GPS 175/GNC355)

The GNX 375 has a built in ADS-B In traffic system. A Garmin ADS-B traffic system may be interfaced to the GPS 175/GNC 355/GNX 375. The nose of the ownship symbol on the GPS 175/GNC 355/GNX 375 main map page and dedicated traffic page serves as the actual location of your aircraft. The center of the traffic target icon serves as the reported location for the target aircraft. Motion vectors for traffic may be displayed in either absolute or relative motion. The location of the traffic targets relative to the ownship are the same, regardless of the selected motion vector.

Absolute motion vectors are colored either cyan or white, depending on unit configuration. Absolute motion vectors depict the reported track of the traffic target referenced to the ground. An absolute motion vector pointed towards your ownship symbol *does not* necessarily mean the traffic target is getting closer to your aircraft.

Relative motion vectors are always colored green and depict the motion of the traffic target relative to your ownship symbol. The direction the traffic target is pointed may vary greatly from the motion vector and a target may be getting closer to your aircraft independent of the direction the target is pointed. A green relative motion vector pointed towards your ownship indicates that the traffic target is converging on your aircraft.

Traffic grouping can be enabled or disabled in the traffic page menu. If grouping is enabled, and more than one target is occupying the same area of the screen, the GPS 175/GNC 355/GNX 375 will combine the two or more traffic targets into one traffic group. The presence of an asterisk to the left of a target indicates that traffic has been grouped. The highest priority traffic target in the group is displayed to the pilot. When applied to airborne targets the asterisk will be displayed in white or cyan depending on the traffic depiction color used in the installation. The asterisk will be brown for grouped ground targets. The asterisk will not turn amber, even if an alerted target is included in the group. If traffic grouping is disabled, the traffic targets will draw on top of one another.

An alerted target may be placed in the same group as non-alerted targets. In this case, the alerted target will be displayed. Two alerted targets will not be placed in the same group. All alerted targets will be displayed on the screen.

Traffic targets displayed on the dedicated traffic page may be selected in order to obtain additional information about a traffic target or to view all targets in a grouped target. When a grouped target is selected, the "Next" button on the dedicated traffic page will cycle through all targets located in close proximity to where the screen has been touched.

7.8 Airspace Depiction and Alerts

The GPS 175/GNC 355/GNX 375 aides the flight crew in avoiding certain airspace with Smart Airspace and airspace alerts. Smart Airspace de-emphasizes depicted airspace that is not near the aircraft's current altitude. Airspace Alerts provide a message indication to the flight crew when the aircraft's current ground track will intercept an airspace type that has been selected for alerting.

NOTE

Smart Airspace and Airspace Alerts are separate features. Turning on/off Smart Airspace does not affect Airspace Alerts, and vice versa.

1.2 System Capabilities

This Flight Manual Supplement documents the installed capabilities of the GPS 175/GNC 355/GNX 375 specific to the aircraft for which this manual is created.

NOTE

In sections which contain a square checkbox (☐) the installer will have placed an "X" in the boxes next to the capabilities applicable to the installation.

The GPS 175/GNC 355/GNX 375 system and associated navigation interface in this aircraft have the following capabilities, in addition to the core multifunction display capability:

- Primary GPS Navigation (Enroute) and Approach Capability (LF/LNAV) – See below
- Primary GPS Approach Capability with Vertical Guidance (LNAV/VNAV, LPV) – See below
- Built in ADS-B In/Out Transponder (GNX 375)

1.3 GNSS (GPS/SBAS) Navigation system Equipment approvals

The Garmin GPS 175/GNC 355/GNX 375 navigator installed in this aircraft is a TSO-C145c Class 3 approved GPS navigator that complies with AC 20-138D. The Garmin GPS 175/GNC 355/GNX 375 system as installed in this aircraft is approved for navigation using GPS and GPS/SBAS (within the coverage of a Satellite Based Augmentation System complying with ICAO Annex 10) for IFR en route, terminal area, non-precision approach, and approach procedures with vertical guidance operations.

The Garmin GPS 175/GNC 355/GNX 375 system as installed in this airplane complies with the equipment, performance, and functional requirements to conduct RNAV operations in accordance with the following table. This table is accurate at the time it was published. However, changes to operational rules, FAA advisory circulars, flight plan formats, etc., are possible. The pilot is responsible to ensure compliance with current operational requirements.

| Navigation Spec | Operational Requirements/ Authorization | Reference Documents | ICAO Flight Plan Code | | Notes |
|---|--|---|-----------------------|--------------|---|
| | | | Item 10a Code | Item 18 PBN/ | |
| RNAV 10 | GNSS FDE availability must be verified prior to flight. Maximum predicted FDE unavailability is 34 minutes. Two GNSS systems required to be operational. (one GNSS system for those routes requiring only one long range navigation system). | FAA AC 20-138D CHG 2, FAA AC 90-105A, FAA AC 91-70B, EASA AMC 20-12 | R | AI | The GPS equipment as installed requires a second GNSS system for Class II navigation in oceanic and remote airspace. When installed with a second GNSS system, the GPS 175/GNC 355/GNX 375 equipment complies with the requirements for GPS primary means of Class II navigation in oceanic and remote airspace, when used in conjunction with an FDE prediction tool that satisfies the guidance of FAA AC 20-138D and AC 90-105A (or later revision). |
| Oceanic Areas of Operation (Class II Navigation) | Part 91, Part 91 subpart K, 121, 125, and 135 operators require operational approval. | | | | Additional equipment may be required to obtain operational approval to utilize RNP-10 performance. |
| 3-RNAV / RNAV 5 (Europe) | This does not constitute an operational approval. | FAA AC 30-96A CHG 2, EASA AMC 20-4A | R | B2 | |
| RNP 4 Oceanic and Remote Areas of Operation (Class II Navigation) | GNSS FDE unavailability must be verified prior to flight. Maximum predicted FDE unavailability is 25 minutes. Two operational long-range navigation systems required for one navigation system and one GNSS sensor for those routes requiring only one | FAA AC 20-138D CHG 2, FAA AC 90-105A, FAA AC 91-70B | R | L1 | The GPS equipment as installed requires a second GNSS system for Class II navigation in oceanic and remote airspace. Additional equipment may be required to obtain operational approval to utilize RNP-4 performance. |

- Power to the optional Flight Stream 510 is provided through the GPS 175/GNC 355/GNX 375 MDM/SD card slot and protected via the GPS 175/GNC 355/GNX 375 circuit breaker.

7.6 Databases and Flight Plan Waypoints/Procedures

Database versions (or cycles) and effective dates are displayed on the start-up database verification page immediately after power-on for those databases with an effective or expiration date. Databases with no effective or expiration date (e.g. - terrain database) are considered effective upon installation in the GPS 175/GNC 355/GNX 375. Database information can also be viewed on the System – System Status page.

The Obstacle Database has an area of coverage that includes the United States and Europe and is updated as frequently as every 56 days. The HOT Line wire database only includes the continental United States and portions of Canada/Mexico.

Only the Obstacle/HOT Line wire database may be used in accordance with the limitation found in Section 2.20.

If a stored flight plan contains a waypoint or procedure that does not correspond to a waypoint or procedure in the navigation database in use, the waypoint or procedure will become locked (depicted as "locked") in the flight plan. Flight plans with locked waypoints may be placed in the active flight plan portion of the system but no navigation will be provided. The locked waypoint/procedure must be reset by removing or replacing it with the correct waypoint/procedure in the flight plan before the system will provide navigation.

7.7 External Switches

External switches may be installed and interfaced to the GPS 175/GNC 355/GNX 375. Table 7 lists the switches and function they perform:

| Switch Label | Function |
|--------------|--|
| TFC MUTR | Mutes the traffic alert audio (GNX 375 only) |
| GA | Remote Go Around |
| IDENNT | Transponder IDENNT |

Table 7 – External Switches

Obstacles and wires on the dedicated terrain page or main map are depicted in the following manner.

- Obstacles and wires more than 2,000 feet below the aircraft are not depicted.
- Obstacles and wires between 2,000 feet and 1,000 feet below the aircraft are depicted as white.
- Obstacles and wires between 1,000 feet and 100 feet below the aircraft are depicted as amber.
- Obstacles and wires within 100 feet below the aircraft, or above the aircraft, are depicted as red.

Multiple obstacles may be depicted using a single obstacle icon and an asterisk to indicate obstacle grouping is occurring. The color of the asterisk indicates the relative altitude of the tallest obstacle in the group. The asterisk does not indicate any information about the relative altitude or number of obstacles not being displayed in the obstacle group.

The Garmin GPS 175/GNC 355/GNX 375 Pilot's Guide provides additional information regarding terrain and obstacle colors and grouped obstacle icons.

The terrain alerting is inhibited in the vicinity of airports in the navigation database. If an airport is not in the database, terrain alerting will still occur. Airports not in the database will not be viewable as airports in the unit. If flying into an airport that is not in the database, the inhibit terrain feature can be used to prevent alerting. The terrain inhibit option is in the menu on the terrain page, and provides a means to prevent all terrain alerts while inhibited. The bottom status bar of the GPS 175/GNC 355/GNX 375 will display TER ENHB, and a message will persist in the message window indicating that the terrain alerts are inhibited.

7.4 Traffic System (Optional for GPS 175/GNC355)

This system is configured for the following type of traffic system. The Garmin Garmin GPS 175/GNC 355/GNX 375 Pilot's Guide provides additional information regarding the functionality of the traffic device.

- GPS 175/GNC 355 with no external traffic source.
- GPS 175/GNC 355 with external ADS-B In Source.
- GNX 375 including built in ADS-B In Source.

7.5 Power

- Power to the GPS 175 or GNC 355 is provided through a circuit breaker labeled GPS or GPS 2.
- Power to the GNX 375 is provided through a circuit breaker labeled GPS/XPDR or GPS/XPDR 2.
- Power to the COM radio in a GNC 355 is provided through a circuit breaker labeled COM or COM2.

| Navigation Spec. | Operational Requirements/ Authorization | Reference Documents | ICAO Flight Plan Code | | Notes |
|------------------|--|--|-----------------------|-------------|-------------------------------|
| | | | Item 10a Code | Item 18 PBN | |
| RNAV 2 | <p>long-range navigation secur).</p> <p>No time limit using GNSS as the primary navigation sensor.</p> <p>Part 91, Part 91 subpart K, 121, 125, and 135 operators require operational approval.</p> <p>The GNSS RNAV system is installed and meets the performance and functional requirements of AC 90-100A.</p> <p>In accordance with AC 90-100A, CHG 2, Part 91 operators (except subpart K) following the aircraft end training guidance in AC 90-100A are authorized to fly RNAV 2 procedures.</p> <p>Part 91 subpart K, 121, 125, 129, and 135 operators require operational approval.</p> | <p>FAA AC 26-138D CHG 2,</p> <p>FAA AC 90-100A CHG 2</p> | R | C2 | Includes RNAV Q and I routes. |

Obstacles and wires on the dedicated terrain page or main map are depicted in the following manner.

- Obstacles and wires more than 2,000 feet below the aircraft are not depicted.
- Obstacles and wires between 2,000 feet and 1,000 feet below the aircraft are depicted as white.
- Obstacles and wires between 1,000 feet and 100 feet below the aircraft are depicted as amber.
- Obstacles and wires within 100 feet below the aircraft, or above the aircraft, are depicted as red.

Multiple obstacles may be depicted using a single obstacle icon and an asterisk to indicate obstacle grouping is occurring. The color of the asterisk indicates the relative altitude of the tallest obstacle in the group. The asterisk does not indicate any information about the relative altitude or number of obstacles not being displayed in the obstacle group.

The Garmin GPS 175/GNC 355/GNX 375 Pilot's Guide provides additional information regarding terrain and obstacle colors and grouped obstacle icons.

The terrain alerting is inhibited in the vicinity of airports in the navigation database. If an airport is not in the database, terrain alerting will still occur. Airports not in the database will not be viewable as airports in the unit. If flying into an airport that is not in the database, the inhibit terrain feature can be used to prevent alerting. The terrain inhibit option is in the menu on the terrain page, and provides a means to prevent all terrain alerts while inhibited. The bottom status bar of the GPS 175/GNC 355/GNX 375 will display TER ENHB, and a message will persist in the message window indicating that the terrain alerts are inhibited.

7.4 Traffic System (Optional for GPS 175/GNC355)

This system is configured for the following type of traffic system. The Garmin Garmin GPS 175/GNC 355/GNX 375 Pilot's Guide provides additional information regarding the functionality of the traffic device.

- GPS 175/GNC 355 with no external traffic source.
- GPS 175/GNC 355 with external ADS-B In Source.
- GNX 375 including built in ADS-B In Source.

7.5 Power

- Power to the GPS 175 or GNC 355 is provided through a circuit breaker labeled GPS or GPS 2.
- Power to the GNX 375 is provided through a circuit breaker labeled GPS/XPDR or GPS/XPDR 2.
- Power to the COM radio in a GNC 355 is provided through a circuit breaker labeled COM or COM2.

| Navigation Spec. | practical requirements/ authorization | Reference Documents | ICAO Flight Plan Code | | Notes |
|------------------|---|--|-----------------------|--------------|---|
| | | | Item 10a Code | Item 18 PBN/ | |
| RNAV 1 | The GNSS RNAV system is installed and meets the performance and functional requirements of AC 90-100A. | FAA AC 20-138D CHG 2, FAA AC 90-100A CHG 2 | R | D2 | Includes RNAV terminal departure, arrival procedures, and approach procedures up to the Final Approach Fix. |
| | In accordance with AC 90-100A, Part 91 operators (except subpart K) following the aircraft and training guidance in AC 90-100A are authorized to fly RNAV 1 procedures. | | | | |
| | Part 91 subpart K, 121, 125, 129, and 135 operators require operational approval. | | | | |
| P-RNAV (Enroute) | This does not constitute an operational approval. | FAA AC 90-96A CHG 1, JAA TGL 10 Rev 1 | R | D2 | ICAO flight plan code for P-RNAV no longer exists. P-RNAV utilizes RNAV 1 flight plan codes. |

Section 7. SYSTEM DESCRIPTIONS

7.1 Pilot's Guide

The Garmin GPS 175/GNC 355/GNX 375 Pilot's Guides, part number and revision listed below, contain additional information regarding GPS 175/GNC 355/GNX 375 system description, control and function.

- GPS175/GNX375 Pilot's Guide P/N 190-02207-02 Rev B or later
- GPS175/GNC 355/GNX375 Pilot's Guide P/N 190-02488-01 Rev B or later

7.2 Leg Sequencing

The GPS 175/GNC 355/GNX 375 supports all ARINC 424 leg types. Certain leg types require altitude input in order to sequence (course to altitude, for example). If a barometric corrected altitude source is not interfaced to the GPS 175/GNC 355/GNX 375, a popup will appear prompting the flight crew to manually sequence the leg once the altitude prescribed in the procedure is reached.

- This installation has a barometric corrected altitude source. The GPS 175/GNC 355/GNX 375 will automatically sequence altitude legs.
- This installation does not have a barometric corrected altitude source. The flight crew will be prompted to manually sequence altitude legs.

7.3 Terrain Alerting

CAUTION

Not all obstacles and wires are contained in the Obstacle/HOT Line database. The system provides depiction and alerts only for obstacles and wires contained in the database.

NOTE

The area of coverage may be modified as additional terrain data sources become available.

The GPS 175/GNC 355/GNX 375 supports Terrain Alerting. Visual alerts are provided. Terrain Alerting does not satisfy the TAWS requirement of 91.223.

Terrain on the dedicated terrain page or main map overlay is depicted in the following manner:

- Terrain more than 1,000 feet below the aircraft is not depicted or depicted as black.
- Terrain between 1,000 feet and 100 feet below the aircraft is depicted as amber.
- Terrain within 100 feet below the aircraft, or above the aircraft, is depicted as red.

Section 5. PERFORMANCE

No change.

Section 6. WEIGHT AND BALANCE

See current weight and balance data.

| Navigation Spec. | Operational Requirements/Authorization | Reference Documents | ICAO Flight Plan Code | | Notes |
|------------------|---|--|-----------------------|-------------|--|
| | | | Item 10a Code | Item 18 PBN | |
| RNP 1 | <p>When flying a RNP procedure containing an RE leg, the AFCS must be operational.</p> <p>At a minimum, the flight director must be displayed and utilized when conducting procedures containing radius-to-fix (RF) legs.</p> <p>In accordance with AC 90-105A, Part 91 operators (except subpart K), following the aircraft and training guidance in AC 90-105A are authorized to fly RNP 1 procedures.</p> <p>Part 91 subpart K, 121, 125, 129, and 135 operators require operational approval.</p> | <p>FAA AC 20-138D CRG 2,</p> <p>FAA AC 90-105A</p> | R | O2 | <p>Includes RNP terminal departure and arrival procedures, including procedures with radius-to-fix (RF) legs. Also includes approach procedures to the Final Approach Fix.</p> <p>AC 90-105A states that procedures with RF legs must be flown using either a flight director or coupled to the autopilot.</p> <p>Garmin has demonstrated acceptable crew workload and Flight Technical Error for hand flown procedures with RF legs when the installation complies with limitation set forth in Section 2.1.1 of this document. It is recommended to couple the autopilot for RF procedures, if available, but it is not required to do so. See section 4.5 of this manual to determine if this capability is supported in this installation.</p> |

| Navigation Spec | Operational Requirements/ Authorization | Reference Documents | ICAO Flight Plan Code | | Notes |
|-------------------------------------|---|--|-----------------------|--------------|--|
| | | | Item 10a Code | Item 18 PBN/ | |
| RNP-2 (Oceanic/ Remote) | GNSS RDE availability must be verified prior to flight. Maximum predicted FDE unavailability is 5 minutes. Two operational long-range navigation systems required, (or one navigation system and one GNSS sensor for those routes requiring only one long-range navigation sensor.) No time limit using GNSS as the primary navigation sensor. Part 91, Part 91 subpart K, 121, 125, and 135 operators require operational approval. | FAA AC 20-138D CHG2, FAA AC 90-105A, FAA AC 91-708 | R | TBD | The OPS equipment as installed requires a second GNSS system for Class II navigation in oceanic and remote airspace. Additional equipment may be required to obtain operational approval in unsize RNP-2 performance. Item 18 PBN flight plan code is still to-be-determined at time of publication of this AFMS. |
| RNP-2 (Domestic/ Offshore En route) | In accordance with AC 90-105A, Part 91 operators (except subpart N) following the enroute and tracking guidance in AC 90-105A are authorized to fly RNP-2 domestic and offshore routes. Per 91 subpart K, 121, 125, 129, and 135 operators require operational approval. | FAA AC 20-138D CFIG 2, FAA AC 90-105A, FAA AC 91-708 | R | TBD | Includes RNP-2 domestic and offshore routes. Item 18 PBN flight plan code is still to-be-determined at time of publication of this AFMS. |

The GPS 175/GNC 355/GNX 375 allows for the utilization of FR procedures that include RF (Radius to Fix) legs as part of RNP 1.0 capabilities.

- This installation is equipped to support coupled RF leg navigation up to RNP 1.0.
- This installation is equipped to support *un-coupled* RF leg navigation up to RNP 1.0.
- This installation does not support RF leg navigation.

4.6 Composite Indicators

When the GPS 175/GNC 355/GNX 375 is interfaced to an existing composite CDI indicator, the TO/From Flag will not function on the indicator. A placard must be installed immediately adjacent to the indicator. The placard must read: "TO/FROM FLAG WILL NOT FUNCTION CORRECTLY WHEN DISPLAYING GPS DEVIATION. USE TO/FROM INDICATION ON GPS."
The following navigation indicators require the placard:

- Narco VOA 50M
- Narco VOA 9
- Narco VOA 8
- ARC (Cassina) IN-386A
- ARC (Cassina) IN-481AC
- ARC (Cassina) IN-385AC
- Honeywell (Bendix King) KI 204
- Honeywell (Bendix King) KI 209
- Honeywell (Bendix King) KI 209A
- Bendix King KI 203
- Bendix King KI 208
- Bendix King KI 208A

These indicators will either show no To/From indication at all, or will only show the "TO" indication. Pilots must use the on screen TO/FROM indications when interfaced to these CDIs.

- This installation is interfaced to a composite navigation indicator and the TO/FROM flag on the indicator will not function correctly.
 - This installation is not interfaced to a composite nav indicator.
- Pilot should set the selected course on the CDI to the desired track.

4.5 Coupling the Autopilot during approaches

CAUTION

When the CDI source is changed on the GPS 175/GNC 355/GNX 375, autopilot mode may change. Confirm autopilot mode selection after CDI source change on the GPS 175/GNC 355/GNX 375. Refer to the FAA approved Flight Manual or Flight Manual Supplement for the autopilot.

Analog only autopilots should use APR mode for coupling to LNAV approaches. Autopilots which support digital roll steering commands (GPS) may utilize NAV mode and take advantage of the digital tracking during LNAV only approaches.

- This installation prompts the flight crew and requires the pilot to enable the approach outputs just prior to engaging the autopilot in APR mode.

To couple an approach:

Once established on the final approach course with the final approach fix as the active waypoint, the GPS 175/GNC 355/GNX 375 will issue a flashing message indication.

Flashing Message Button..... **PRESS**
 "Enable APR Output" Button..... **PRESS**

If coupled, Autopilot will revert to ROL mode at this time.

Autopilot..... **ENGAGE APPROACH MODE**

- This installation supports coupling to the autopilot in approach mode once vertical guidance is available.

To couple an approach:

Once established on the final approach course with the final approach fix as the active waypoint, the GPS 175/GNC 355/GNX 375 will enable vertical guidance.

Vertical Guidance..... **CONFIRM AVAILABLE**
 Autopilot..... **ENGAGE APPROACH MODE**

- The installation *does not* support any vertical capture or vertical tracking.

| Navigation Spec. | Operational Requirements/ Authorization | Reference Documents | ICAO Flight Plan Code | | Notes |
|----------------------|--|---|-----------------------|-------------|---|
| | | | Item 10a Code | Item 18 PRN | |
| RNP APCH LNAV minima | When flying a RNP procedure with a radius-to-fix (RF) leg, the AFCS must be operational. At a minimum, the flight director must be displayed and utilized when conducting approach procedures containing RF legs. In accordance with AC 90-105A, Part 91 operators (except subpart K), following the aircraft and training guidance in AC 90-105A are authorized to fly RNP APCH LNAV minima procedures. Part 91 subpart K, 121, 125, 129, and 135 operators require operational approval. | FAA AC 20-138D CTO 2, FAA AC 90-105A, EASA AMC 20-27A | R | S1 | Includes non-precision approaches based on conventional navigation aids with "or GPS" in the title and area navigation approaches titled "GPS", "RNAV (GPS)", and "RNAV (GNSS)". This includes procedures with radius-to-fix (RF) legs. Garmin has demonstrated acceptable crew workload and Flight Technical Error for hand flown procedures with RF legs when the installation complies with information set forth in Section 2.11 of this document. It is recommended to couple the autopilot for RF procedures, if available, but it is not required to do so. See section 4.5 of this manual to determine if this capability is supported in this installation. |

For autopilot operating instructions, refer to the FAA approved Flight Manual or Flight Manual Supplement for the autopilot.

| Navigation Spec | Performance/Requirements/Authorization | Reference Documents | ICAO Flight Plan Code | | Notes |
|--------------------------------|--|--|-----------------------|--------------|---|
| | | | Item 10a Code | Item 18 PBN/ | |
| RNP APCH LNAV/VNAV AV obstacle | When flying a RNP procedure with a radius-to-fix (RF) leg, the AFCS must be operational. At a minimum, the flight director must be displayed and utilized when conducting procedures containing RF legs. | FAA AC 20-138D CHG 2, FAA AC 90-105A, EASA AMC 20-27A with CM-AS-302 | R | S2 | Includes area navigation approaches titled "RNAV (GPS)" and "RNAV (GNSS)". This includes procedures with radius-to-fix (RF) legs. Garmin has demonstrated acceptable crew workload and flight Technical Errors for hand flown procedures with RF legs when the installation complies with Section 2.11 of this |
| RNP APCH LP obstacle | When flying a RNP procedure with a radius-to-fix (RF) leg, the AFCS must be operational. At a minimum, the flight director must be displayed and utilized when conducting procedures containing RF legs. In accordance with AC 90-107, Part 91 operators (except subpart K), following the | FAA AC 20-138D CHG 2, FAA AC 90-107 | N/A | N/A | Includes area navigation approaches titled "RNAV (GPS)" and "RNAV (GNSS)" including procedures with radius-to-fix (RF) legs. LP minima are available only when within SSAS coverage. Garmin has demonstrated acceptable crew workload and Flight Technical Errors for hand flown procedures with RF legs when the installation complies with Section 2.11 of this |

4.3 HSI and EHSI Operation
If an HSI is used to display navigation data from the GPS 175/GNC 355/GNX 375 the pilot should rotate the course pointer as prompted on the GPS 175/GNC 355/GNX 375.

If an EHSI is used to display navigation data from the GPS 175/GNC 355/GNX 375 the course pointer may autoslew to the correct course when using GPS navigation. For detailed information about the functionality of the EHSI system, refer to the FAA approved Flight Manual or Flight Manual Supplement for that system.

CAUTION

The pilot must verify the active course and waypoint for each flight plan leg. The pilot must verify proper course selection each time the CDI source is changed from GPS to VLOC.

See Section 4.5 for RF leg capabilities related to EHSI.

4.4 Autopilot Operation

The GPS 175/GNC 355/GNX 375 may be coupled to an optional autopilot, if installed in the aircraft, when operating as prescribed in the LIMITATIONS section of this manual.

Autopilots coupled to the GPS 175/GNC 355/GNX 375 system in an analog (NAV) mode will follow GPS navigation guidance as they would with existing VOR receivers.

Autopilots that support GPSS or GPS Roll Steering in addition to the analog course guidance will lead course changes, fly arcing procedures, procedure turns, and holding patterns if coupled in a roll steering mode.

The GPS 175/GNC 355/GNX 375 supports autopilot roll steering for heading legs when an approved heading source is interfaced to the GPS 175/GNC 355/GNX 375. This heading interface can also provide map orientation, traffic heading data, and wind calculations.

CAUTION

The GPS 175/GNC 355/GNX 375 does not provide course deviation to the autopilot for heading legs. Some autopilots do not allow the use of roll steering when course deviation is not provided.

- This installation *has* a heading source. The GPS 175/GNC 355/GNX 375 will provide roll steering on heading legs for the autopilot.
- This installation *does not have* a heading source. The crew cannot use the GPS 175/GNC 355/GNX 375 roll steering to fly heading legs with the autopilot.

| Navigation Spec. | Operational Requirements/Authorization | Reference Documents | ICAO Flight Plan Code | | Notes |
|---------------------|---|--|-----------------------|--------------|--|
| | | | Item 10a Code | Item 18 PBN/ | |
| | <p>aircraft and training guidance in AC 90-107 are authorized to fly RNP APCH LP minima procedures.</p> <p>Part 91 subpart K, 121, 125, 129, and 135 operators require operational approval.</p> | | | | document. It is recommended to couple the autopilot for RF procedures, if available, but it is not required to do so. See section 4.5 of this manual to determine if this capability is supported in this installation. |
| RNP APCH LPV minima | <p>When flying a RNP procedure with a radius-to-fix (RF) leg, the AFCS must be operational. At a minimum, the flight director must be displayed and utilized when conducting procedures containing RF legs.</p> <p>In accordance with AC 90-107, Part 91 operators (except subpart K), following the aircraft and training guidance in AC 90-107 are authorized to fly RNP APCH LPV minima procedures.</p> <p>Part 91 subpart K, 121, 125, 129, and 135 operators require operational approval.</p> | <p>FAA AC 20-138D CHG 2,</p> <p>FAA AC 90-107,</p> <p>EASA AMC 20-28</p> | B | N/A | <p>Indicates area navigation approaches titled "RNAV (GPS)" and "RNAV (GNSS)", including procedures with radius-to-fix (RF) legs.</p> <p>LPV minima are available only when within SBAS coverage.</p> <p>Garmin has demonstrated acceptable crew workload and Flight Technical Error for land flown procedures with RF legs when the installation complies with limitation per force in Section 2.11 of this document. It is recommended to couple the autopilot for RF procedures, if available, but it is not required to do so. See section 4.5 of this manual to determine if this capability is supported in this installation.</p> |

| Navigation Spec. | Operational and/or Instrument/ Authorization | Reference Documents | ICAO Flight Plan Code | | Notes |
|--|---|--------------------------------------|-----------------------|--------------|--|
| | | | Item 10a Code | Item 18 PBN/ | |
| Advanced RNP See Notes for specific Advanced RNP functions. | This does not constitute an operational approval. | FAA AC 20-138D CHG 2, FAA AC 90-105A | N/A | N/A | <ul style="list-style-type: none"> RNAV Holding: Supported. RFLess: Supported. Parallel Offset: RNP-4 parallel offset as defined by AC 20-138D Chapter 1C are supported. Advanced RNP parallel offset as defined by AC 20-138D Appendix 1 are supported. Higher Capability: supported only when a second GNSS system is installed and operating. Scaleable RNP: Not supported. Fixed Radius Transitions (FRT): Not Supported Time of Arrival Control (TOAC): Not supported |

1. WDE/RAIM availability worldwide can be determined via the following:

An FDE prediction tool that satisfies the guidance of FAA AC 20-138D and AC 90-105A (or later revisions), such as the Garmin WDE Prediction program, part number 006-A0154-01 or later approved version with GPS SW v= 3.0 selected

Also, within the United States:

- Via the FAA's RAIM Service Availability Prediction Tool (SAPT) website: <http://www.faa.gov/aim>
- Contacting a Flight Service Station (not DUATS) to obtain non-precision approach RAIM

Section 4. NORMAL PROCEDURES

Refer to the GPS 175/GNC 355/GNX 375 Pilot's Guide defined in Section 7.1 of this document for normal operating procedures and a complete list of system messages and associated flight crew actions. This includes all GPS operations, navigation, traffic, weather, and Multi-Function Display information.

The GPS 175/GNC 355/GNX 375 requires a reasonable degree of familiarity to avoid becoming too engrossed at the expense of basic instrument flying in DMC and basic see-and-avoid in VMC. Garmin provides training tools with the Pilot's Guide and PC based simulator. Pilots should take full advantage of these training tools to enhance system familiarization.

4.1 Unit Power On

Databases REVIEW DATES
Self-Test VERIFY OUTPUTS TO NAV INDICATORS
Self-Test - GPS Remote Annunciator:
LOI ILLUMINATED
APPR ILLUMINATED

For GNC 375:

Transponder Mode VERIFY ALT

4.2 Before Takeoff

System Messages and Annunciators CONSIDERED

3.2.5 TER N/A and TER FAIL.

If the amber **TER N/A** or **TER FAIL** status annunciator is displayed, the system will no longer provide terrain alerting or display relative terrain and obstacle elevations. The crew must maintain compliance with procedures that ensure minimum terrain and obstacle separation.

3.2.6 DATA SOURCE - HEADING SOURCE INOPERATIVE OR CONNECTION LOST MESSAGE

Without a heading source to the GPS 175/GNC 355/GNX 375, the following limitations apply:

- Roll steering will not be provided to the autopilot for heading legs. The autopilot must be placed in HDG mode for heading legs.
- Map cannot be oriented to Heading Up.
- Overlaying traffic data from Garmin ADS-B-IN unit will not be displayed on the main map display. The flight crew must use the dedicated traffic page on the GPS 175/GNC 355/GNX 375 system to display ADS-B-IN traffic data.

3.2.7 DATA SOURCE -- PRESSURE ALTITUDE SOURCE INOPERATIVE OR CONNECTION TO GNX 375 LOST MESSAGE

The GNX 375 will not be receiving pressure altitude while that message is present.

3.2.8 UNRECOVERABLE LOSS OF ALL ELECTRICAL GENERATORS OR ALTERNATORS

Remove power from all equipment which is not necessary for flight.

3.2.9 IN-AIR RESTART OF GPS 175/GNC 355/GNX 375

In the event of a GPS 175/GNC 355/GNX 375 restart in the air, the crew should utilize the Back button if presented with the database update screen after the GPS 175/GNC 355/GNX 375 is restarted. This will ensure restoration of the navigation functions as soon as possible.

- Using the Garmin WIDE Prediction program.
- An FDE prediction tool that satisfies the guidance of FAA AC 20-138D and AC 90-105A (or later revision)
- Europe's AUGER GPS RAIM Prediction Tool at <http://auger.ecanav.com/augur/app/come>.

This requirement is not necessary if SBAS coverage is confirmed to be available along the entire route of flight. The route planning and WIDE prediction program may be downloaded from the Fly-Garmin website on the internet (fly.garmin.com/fly-garmin/support/). For information on using the WIDE Prediction Program, refer to GARMIN WAAS FDE Prediction Program, part number 150-00643-01, 'WIDE Prediction Program Instructions'.

Garmin International holds an FAA Type 2 Letter of Acceptance (LOA) in accordance with AC 20-138A for database integrity, quality, and database management practices for the Navigation database. Flight crews and operators can view the LOA status at fly.garmin.com then select "Aviation Database Declarations".

Navigation information is referenced to the WGS-84 reference system.

1.4 Definitions

The following terminology is used within this document:

| | |
|-----------------|--|
| ADF: | Automatic Direction Finder |
| ADS-B: | Automatic Dependent Surveillance Broadcast |
| APR: | Approach |
| APPR: | Approach |
| CDI: | Course Deviation Indicator |
| DME: | Distance Measuring Equipment |
| ECAC: | European Civil Aviation Conference |
| EHSI: | Electronic Horizontal Situation Indicator |
| FIS-B: | Flight Information Services Broadcast |
| GNSS: | Global Navigation Satellite System |
| GPA: | Glidepath Angle |
| GPS: | Global Positioning System |
| GPSS: | GPS Roll Steering |
| HOT: | Hazardous Obstacle Transmission wires |
| HSI: | Horizontal Situation Indicator |
| IAP: | Instrument Approach Procedure |
| IFR: | Instrument Flight Rules |
| ILS: | Instrument Landing System |
| IMC: | Instrument Meteorological Conditions |
| LDA: | Localizer Directional Aid |
| LNAV: | Lateral Navigation |
| LNAV +V: | Lateral Navigation with advisory Vertical Guidance |
| L/VNAV: | Lateral/Vertical Navigation |

AFMS, Garmin GPS/GNC/GNX System 190-02207-A3 Rev. 3
FAA APPROVED Page 15

LC: Localizer
LOC-BC: Localizer Backcourse
LP: Localizer Performance
LPV: Localizer Performance with Vertical Guidance
LP+V: Localizer Performance with Advisory Vertical Guidance
MLS: Microwave Landing System
MMIC: Multi-Media Card
NOTAM: Notice to Airmen
OBS: Omni Bearing Selector
PED: Portable Electronic Device
RAIM: Receiver Autonomous Integrity Monitoring
RF Leg: Radius-To-Fix Leg of a Charted Instrument Procedure
RNAV: Area Navigation
RNP: Required Navigational Performance
SBAS: Satellite Based Augmentation System
SD: Secure Digital
SDR: Simplified Directional Facility
SUSP: Suspend
TACAN: Tactical Air Navigation System
TAAWS: Terrain Awareness and Warning System
TCH: Threshold Crossing Height
TER: Temporary Flight Restriction
TIS: Traffic Information Service
VFR: Visual Flight Rules
VGSI: Visual Glide-Slope Indicator
VLOC: VOR/Localizer
VMC: Visual Meteorological Conditions
VOR: VHF Omnidirectional Range
VRP: Visual Reporting Point
WAAS: Wide Area Augmentation System
WYDE: WAAS Fault Data Exclusion

NOTE

The airplane symbol is removed from all maps. The map will remain centered at the last known position. "NO GPS POSITION" will be annunciated in the center of the map.

3.2.2 GPS APPROACH DOWNGRADE

During a LPV, LP+V, LNAV/VNAV, or LNAV+V approach, if GPS accuracy requirements cannot be met by the GPS receiver, the GPS 175/GNC 355/GNX 375 will downgrade the approach. The downgrade will remove vertical deviation indication from the VDI and change the approach annunciation to LNAV. The approach may be continued using the LNAV only minimums. If the VISUAL approach is downgraded, the GPS 175/GNC 355/GNX 375 will remove the vertical deviation indication from the VDI, but continue to annunciate VISUAL in amber.

During a GPS approach in which GPS accuracy requirements cannot be met by the GPS receiver for any GPS approach type, the GPS 175/GNC 355/GNX 375 will flag all CDI guidance and display a system message "ABORT APPROACH-GPS approach no longer available". Immediately upon viewing the message, the unit will revert to Terminal navigation mode alarm limits. If the position integrity is within these limits lateral guidance will be restored and the GPS may be used to execute the missed approach, otherwise alternate means of navigation must be utilized.

3.2.3 Terrain CAUTION (Terrain or Obstacle Ahead, Sink Rate, Don't Sink)

When a terrain CAUTION occurs, take corrective action until the alert ceases. Stop descending or initiate either a climb or a turn, or both as necessary, based on analysis of all available instruments and information.

NOTE

Terrain annunciators external to the GPS 175/GNC 355/GNX 375 may not indicate the exact threat causing the alert. Example: WIRE alerts may be annunciated as TERR or OBSTACLE on external devices.

3.2.4 Terrain INHIBIT

The Forward Looking Terrain Avoidance (FLTA) and Preanabure Descent Alerts (PDA) functions may be inhibited to prevent alerting, if desired. Refer to GPS 175/GNC 355/GNX 375 Pilot's Guide for additional information.

To Inhibit Terrain Alerting:

Home Hardkey **PRESS**
 Terrain Button **PRESS**
 Menu Button **PRESS**

3.2 Abnormal Procedures

3.2.1 LOSS OF GPS/SBAS NAVIGATION DATA

When the GPS/SBAS receiver is inoperative or GPS navigation information is not available or invalid, the GPS 175/GNC 355/GNX 375 will enter one of two modes: Dead Reckoning mode (DR) or Loss Of Integrity mode (LOI). The mode is indicated on the GPS 175/GNC 355/GNX 375 by an amber "DR" and/or "LOI".

If the LOI annunciation is displayed, revert to an alternate means of navigation appropriate to the route and phase of flight. If LOI occurs while the GPS 175/GNC 355/GNX 375 is in the ENR or OCN phase of flight, it may also display DR.

If the DR annunciation is displayed, the map will continue to be displayed with an amber "DR" overwriting the ownship icon. Course guidance will be removed on the CDI. Aircraft position will be based upon the last valid GPS position, then estimated by Dead Reckoning methods. Changes in true airspeed, altitude, heading, or winds aloft can affect the estimated position substantially.

With a GNX 375, loss of GPS will result in the loss of ADS-B Out transmissions.

If Alternate Navigation Sources (ILS, LOC, VOR, DME, ADF) Are Available:

Navigation..... **USE ALTERNATE SOURCES**

If No Alternate Navigation Sources Are Available:

DEAD RECKONING (DR) MODE:

Navigation..... **USE GPS 175/GNC 355/GNX 375**

NOTE

All information normally derived from GPS will become less accurate over time.

LOSS OF INTEGRITY (LOI) MODE (no DR annunciated on the GPS 175/GNC 355/GNX 375):

Navigation..... **FLY TOWARDS KNOWN VISUAL CONDITIONS**

NOTE

All information derived from GPS will be removed.

Section 2. LIMITATIONS

2.1 Kinds of Operation

This AFM supplement does not grant approval for IFR operations to aircraft limited to VFR operations. The following checkboxes indicate only if the navigator installation meets all STC requirements for VFR or IFR flight per the STC Installation Manual section 3.3.1.

- This GPS 175/GNC 355/GNX 375 navigator installation meets the STC requirements for VFR flight only
- This GPS 175/GNC 355/GNX 375 navigator installation meets the requirements for IFR flight

2.2 Minimum Equipment

The GPS 175/GNC 355/GNX 375 must have the following system interfaces fully functional in order to be used for primary navigation during IFR operations:

| Interfaced Equipment | Number installed | Number Required for IFR |
|-----------------------------------|------------------|-------------------------|
| External HSI/CDU/EHSI | 1 or more | 1 |
| External APPR and LOI Annunciator | See Note 1 | 1 |

Table 2 – Required Equipment

Note 1: Certain installations require an external APPR and LOI annunciator light. If installed, these annunciators must be fully functional to use the GPS 175/GNC 355/GNX 375 GPS navigation for IFR operations.

Single engine piston aircraft under 6,000 lbs. maximum takeoff weight:
Required Equipment for IFR operations utilizing GPS navigation: Single GPS 175/GNC 355/GNX 375 Navigator

All other aircraft:

Required Equipment for IFR operations utilizing GPS navigation: Single GPS 175/GNC 355/GNX 375 Navigator plus a second source of TSO-C146 approved GPS navigation or a separate source of VHF navigation.

Operation in remote or oceanic operation requires two sources of GPS navigation.

The GNX 375 JSI have the following system interfaces fully functional in order to be compliant with the requirements for 14 CFR 91.227 ADS-B Out operations:

| Interfaced Equipment | Number Installed | Number Required |
|--------------------------------------|------------------|-----------------|
| Uncorrected Pressure Altitude Source | 1 | 1 |

Table 3 -- Required Equipment

2.3 ADS-B Out

The GNX 375 only complies with 14 CFR 91.227 for ADS-B Out when all required functions are operational. When the system is not operational, ADS-B Out transmit failure messages will be present on the display interface.

2.4 Pressure Altitude Broadcast Inhibit (PABD)

Pressure Altitude Broadcast Inhibit shall only be enabled when requested by Air Traffic Control while operating within airspace requiring an ADS-B Out compliant transmitter. PABD is enabled by selecting the GNX transponder to ON mode.

Section 3. EMERGENCY PROCEDURES

3.1 Emergency Procedures

3.1.1 Terrain Warning

Red annunciator "PULL UP":

Autopilot..... DISCONNECT
 Aircraft Controls..... INITIATE MAXIMUM POWER CLIMB
 Airspeed..... BEST ANGLE OF CLIMB SPEED

After Warning Ceases:

Altitude..... CLIMB AND MAINTAIN SAFE ALTITUDE
 Advise ATC of Altitude Deviation, if appropriate.

NOTE

Only vertical maneuvers are recommended, unless either operating in visual meteorological conditions (VMC) or the flight crew determines, based on all available information, that turning in addition to the vertical escape maneuver is the safest course of action, or both.

NOTE

Terrain annunciators external to the GPS 175/GNC 355/GNX 375 may not indicate the exact threat causing the alert. Example: WTRR alerts may be annunciated as TERR or OBSTACLE on external devices.

2.25 Placards

The GPS 175/GNC 355/GNX 375 STC adds placards if required per STC Installation Manual. The wording and locations of the placards are listed in the table below.

| Placard | Location (If installed) |
|---|--|
| "TO/FROM FLAG WILL NOT FUNCTION CORRECTLY WHEN DISPLAYING GPS DEVIATION. USE TO/FROM INDICATION ON GPS" | Immediately adjacent to the composite CDI indicator. |
| "GPS LIMITED TO VFR USE ONLY" | Immediately adjacent to the GPS 175/GNC 355/GNX 375. |

Table 6 - STC Placards

- A placard for composite indicators is installed.
- A placard for VFR only operations is installed.
- No placards are installed as a result of this STC.

2.5 Flight Planning

For flight planning purposes, in areas where SBAS coverage is not available, the flight crew must check RAIM availability. An acceptable means of compliance for FDE prediction programs is to use a certified service which meets the requirements of FAA AC 20-138D and FAA AC 90-105A for prediction.

The following table describes some of the available RAIM prediction programs.

| Prediction Program | Internet address or program details | Coverage Area |
|--|---|--------------------|
| Garmin RAIM Prediction Tool | https://fly.garmin.com/fly-garmin/support/raim/ | Worldwide |
| FAA Service Availability Prediction Tool | http://sapt.faa.gov | US Only |
| Flight Service Station | 1-800-WXBRLEP https://www.1800wxbrief.com | US Only |
| AUGER GPS RAIM Prediction Tool | http://augur.ecacnav.com/augur/app/home | ECAC Airspace Only |

Table 4 - RAIM Prediction Sources

This RAIM availability requirement is not necessary if SBAS coverage is confirmed to be available along the entire route of flight.

For flight planning purposes, for operations within the U.S. National Airspace System on RNP and RNAV procedures when SBAS signals are not available, the availability of GPS RAIM shall be confirmed for the intended route of flight. In the event of a predicted continuous loss of RAIM of more than five minutes for any part of the intended route of flight, the flight shall be delayed, canceled, or rerouted on a track where RAIM requirements can be met. The flight may also be re-planned using non-GPS based navigational capabilities.

For flight planning purposes for operations within European B-RNAV/RNAV-5 and P-RNAV airspace, if more than one satellite is scheduled to be out of service, then the availability of GPS RAIM shall be confirmed for the intended flight (route and time). In the event of a predicted continuous loss of RAIM of more than five minutes for any part of the intended flight, the flight shall be delayed, canceled, or rerouted on a track where RAIM requirements can be met.

Applicable to dual installations consisting of two Garmin GNSS units:

For flight planning purposes, for operations where the route requires Class II navigation the aircraft's operator or flight crew must use the Garmin RAIM Prediction program to demonstrate that there are no outages on the specified route that would prevent the Garmin GNSS navigation system to provide GPS Class II navigation in oceanic and

AFMS, Garmin GPS/GNC/GNX System
FAA APPROVED

remains of operation that requires RNP-10, RNP-4, or RNP-2 oceanic/remote capability. If the Garmin RAIM Prediction program indicates fault exclusion (FDB) will be unavailable for more than 34 minutes in accordance with FAA Order 8400.12A for RNP-10 requirements, 25 minutes in accordance with FAA Order 8400.33 for RNP-4 requirements, or 5 minutes in accordance with FAA Order 8400.33 for RNP-2 oceanic/remote then the operation must be rescheduled when FDB is available.

Both Garmin GPS navigation receivers must be operating and providing GPS navigation guidance for operations requiring RNP-4, RNP-10, or RNP-2 oceanic/remote performance.

Whenever possible, RNP and RNAV routes including Standard Instrument Departures (SIDs), Standard Terminal Arrival (STAR), and enroute RNAV "Q" and RNAV "Y" routes should be loaded into the flight plan from the database in their entirety, rather than loading route waypoints from the database into the flight plan individually. Selecting and inserting individual named fixes from the database is permitted, provided all fixes along the published route to be flown are inserted. Manual entry of waypoints using latitude/longitude or place/bearing is prohibited.

It is not acceptable to flight plan a required alternate airport based on RNAV(GPS) LEP/LPV or LNAV/VNAV approach minimums. The required alternate airport must be flight planned using an LNAV approach minimums or available ground-based approach aid.

Navigation information is referenced to the WGS-84 reference system, and should only be used where the Aeronautical Information Publication (including electronic data and aeronautical charts) conform to WGS-84 or equivalent.

2.6 System Use

The only approved sources of course guidance are on the external CDI, HSI, or EHSI display. The moving map and CDI depiction on the GPS 175/GNC 355/GNX 375 display are for situational awareness only and are not approved for course guidance.

2.17 Flight Planner/Calculator Functions

The Fuel Planning page uses Fuel on Board as entered by the pilot when on the Fuel Planning page. This is *not* a direct indication of actual aircraft fuel on board and those values are only used for the Fuel Planning page. The fuel required to destination is only a calculated and predicted value based on the data entered into the planner. It is not a direct indication of how much fuel the aircraft will have upon reaching the destination.

2.18 Glove Use / Covered Fingers

No device may be used to cover fingers used to operate the GPS 175/GNC 355/GNX 375 unless the Glove Qualification Procedure located in the Pilot's Guide has been successfully completed. The Glove Qualification Procedure is specific to a pilot / glove / GPS 175/GNC 355/GNX 375 combinations.

2.19 Demo Mode

Demo mode may not be used in flight under any circumstances.

2.20 Wire Obstacle Database

Only the "Obstacle/HOT Line" database may be used. Use of the "Obstacle/Wire" database is prohibited. The database version can be viewed on the start-up database verification or System-System Status pages.

2.21 Portable Electronic Devices

This STC does not relieve the operator from complying with the requirements of 91.21 or any other operational regulation regarding portable electronic devices.

The Bluetooth interface and data provided to a portable electronic device is not approved to replace any aircraft display equipment, including navigation or traffic/weather display equipment.

2.22 Database Updates

Database updates via MMC / SD card or Flight Stream wireless transfers must be done while the aircraft is on the ground and stationary. In-flight database transfers or updates are prohibited unless part of the Database SYNC function that occurs in the background to move databases from one JRU to another.

2.23 OBS Mode

Use of OBS mode for flight plan segments greater than 250nm is prohibited. OBS Mode is not available between the FAF and MAP of any instrument approach.

2.24 Advisory Visual Approaches

All advisory visual approaches shall be conducted in VMC. Advisory visual approaches are intended to be used as an aid to situational awareness and do not guarantee terrain or obstruction clearance along the approach path. Use of advisory visual approaches in DMC is prohibited.

2.13 Terrain Alerting Function

Terrain, point obstacle, and wire obstacle information appears on the map and terrain display pages as red and amber terrain, obstacles, or wires and is depicted for advisory use only. Aircraft maneuvers and navigation must not be predicated upon the use of the terrain display. Terrain, obstacle and wire information is advisory only and is not equivalent to warnings provided by TAWS.

The terrain display is intended to serve as a situational awareness tool only. By itself, it may not provide either the accuracy or the fidelity on which to base decisions and plan maneuvers to avoid terrain or obstacles.

2.14 Polar Operations

Use of the GPS 175/GNC 355/GNX 375 for primary navigation for latitudes above 89.00° N and below 89.00° S is prohibited.

2.15 ADS-B Weather (Optional for GPS 175/GNC355)

This limitation applies to datalink weather products from FIS-B via a GDL 88, GTX 345, or the internal transponder in a GNX 375.

Do not use data link weather information for maneuvering in, near, or around areas of hazardous weather. Information provided by data link weather products may not accurately depict current weather conditions.

Do not use the indicated data link weather product age to determine the age of the weather information shown by the data link weather product. Due to time delays inherent in gathering and processing weather data for data link transmission, the weather information shown by the data link weather product may be significantly older than the indicated weather product age.

Do not rely solely upon data link services to provide Temporary Flight

Restriction (TFR) or Notice to Airmen (NOTAM) information. Not all TFRs and NOTAMS can be depicted on the GPS 175/GNC 355/GNX 375.

Datalink text weather is decoded for the convenience of the pilot, however it is possible that the decoding may be affected by anomalies in the data or differences in the units of measure between the decoding system and the text weather source. All text weather displayed on the GPS 175/GNC 355/GNX 375 also includes the raw weather text for pilot review.

2.16 Traffic Display (Optional for GPS 175/GNC355)

Traffic is displayed on the GNX 375, and may be displayed on the GPS 175 when connected to an approved optional ADS-B traffic device. These systems are capable of providing traffic monitoring and alerting to the flight crew. Traffic shown on the display may or may not have traffic alerting available. The display of traffic is an aid to visual acquisition and may not be utilized for aircraft maneuvering.

Traffic is displayed in feet regardless of the unit settings.

2.7 Applicable System Software

This AFMS/AFM is applicable to the software versions shown in Table 5.

The Main and GPS software versions are displayed on the start-up page immediately after power-on. All software versions displayed in Table 5 can be viewed on the System – System Status or Context Setup pages.

| Software Item | Software Version (or later FAA Approved versions for this STC) |
|-------------------|---|
| Main SW Version | 3.10 |
| GPS SW Version | 8.0 |
| COM SW Version | 2.50 |
| XPDR SW Version | 2.54 |
| Flight Stream 510 | 2.50 |

Table 5 - Software Versions

2.8 Navigation Database

GPS/SBAS based IFR enroute, oceanic, and terminal navigation is prohibited unless the flight crew verifies and uses a valid, compatible, and current navigation database or verifies each waypoint for accuracy by reference to current approved data.

“GPS”, “or GPS”, and “RNAV (GPS)” instrument approaches using the Garmin navigation system are prohibited unless the flight crew verifies and uses the current navigation database. GPS based instrument approaches must be flown in accordance with an approved instrument approach procedure that is loaded from the navigation database.

Discrepancies that invalidate a procedure should be reported to Garmin International. The affected procedure is prohibited from being flown using data

from the navigation database until a new navigation database is installed in the aircraft and verified that the discrepancy has been corrected. Navigation database discrepancies can be reported at FlyGarmin.com by selecting “Aviation Data Error Report.” Flight crew and operators can view navigation database alerts at FlyGarmin.com then select “NavData Alerts.”

If the navigation database cycle will change during flight, the flight crew must ensure the accuracy of navigation data, including suitability of navigation facilities used to define the routes and procedures for flight. If an amended chart affecting navigation data is published for the procedure, the database must not be used to conduct the procedure.

See Section 2.22 for limitations regarding database update procedures.

2.9 Ground Operations

Do not use SafeTaxi functions as the basis for ground maneuvering. SafeTaxi functions do not comply with the requirements of AC 120-76D and are not qualified to be used as an airport moving map display (AMMD). SafeTaxi is to be used by the flight crew to orient themselves on the airport surface to improve flight crew situational awareness during ground operations.

- 2.10 Instru. Approaches**
- Instrument approaches using GPS guidance may only be conducted when the GPS 175/GNC 355/GNX 375 is operating in the approach mode. (LNAV, LNAV +V, L/VNAV, LPV, LP, or LP +V)
 - When conducting instrument approaches referenced to true North, the NAV Angle on the System -Units page must be set to True.
 - The navigation equipment required to join and fly an instrument approach procedure is indicated by the title of the procedure and notes on the IAP chart. Navigating the final approach segment (that segment from the final approach fix to the missed approach point) of an ILS, LOC, LOC BC, LDA, SDF, ME S, VOR, TACAN approach, or any other type of approach not approved for GPS, is not authorized with GPS navigation guidance. GPS guidance can only be used for approach procedures with GPS or RNAV in the procedure title. When using the VOR or ADF receiver to fly the final approach segment of a VOR or NDB approach, GPS may be the selected navigation source so long as the VOR or NDB station is operational and the signal is monitored for final approach segment alignment.
 - Advisory vertical guidance deviation is provided when the GPS 175/GNC 355/GNX 375 annunciates LNAV + V or LP +V. Vertical guidance information displayed on the VDI in this mode is only an aid to help flight crews comply with altitude restrictions. When using advisory vertical guidance, the flight crew must use the primary barometric altimeter to ensure compliance with all altitude restrictions.
 - Not all published Instrument Approach Procedures (IAP) are in the navigation database. Flight crews planning to fly an RNAV instrument approach must ensure that the navigation database contains the planned RNAV Instrument Approach Procedure and that approach procedure must be loaded from the navigation database into the GPS 175/GNC 355/GNX 375 system flight plan by its name. Pilots are prohibited from flying any approach path that contains manually entered waypoints.
 - IFR approaches are prohibited whenever any physical or visual obstruction (such as a throw-over-yoke) restricts pilot view or access to the GPS 175/GNC 355/GNX 375 and/or the CDI.

2.11 RF Legs

This STC does not grant operational approval for RF leg navigation for those operators requiring operational approval. Additional FAA approval may be required for those aircraft intending to use the GPS 175/GNC 355/GNX 375 as a means to provide RNP 1 navigation in accordance with FAA Advisory Circular AC 90-105A.

The following limitations apply to procedures with RF legs:

- Aircraft is limited to 180 KIAS while on the RF leg
- RF legs are limited to RNP 1 procedures. RNP AR and RNP <1 are not approved
- Primary navigation guidance on RF legs must be shown on an EHSI indicator with auto-slew capability turned ON
- GPS 175/GNC 355/GNX 375 Moving Map, EHSI Map, or Distance to Next Waypoint information must be displayed to the pilot during the RF leg when flying without the aid of the autopilot or flight director.
- The active waypoint must be displayed in the pilot's primary field of view.

2.12 Autopilot Coupling

The flight crew may fly all phases of flight based on the navigation information presented to the flight crew; however, not all modes may be coupled to the autopilot. All autopilots may be coupled in Oceanic (OCN), Enroute (ENR), and Terminal (TERM) modes.

This installation is limited to:

- Lateral coupling only for GPS approaches. Coupling to the vertical path for GPS approaches is not authorized.

It is possible to create flight plan waypoint sequences, which exceed the autopilot's bank angle capabilities. The pilot shall monitor autopilot performance with regard to flight path deviation.

2.12.1 RNP 1.0 RF Leg Types

AC 90-105A states that procedures with RF legs must be flown using either a flight director or coupled to the autopilot.

Garmin has demonstrated acceptable crew workload and Flight Technical Error for hand flown procedures with RF legs when the installation complies with limitation set forth in Section 2.11 of this document. It is recommended to couple the autopilot for RF procedures, if available, but it is not required to do so. See Section 4.5 of this manual to determine if this capability is supported in this installation.